



CASABLANCA®
FAN COMPANY

2011 COLLECTION

TABLE OF CONTENTS

INTRODUCTION

What's New	2-3
Quality in Every Detail	4-5
Comprehensive Warranty	6
Energy Efficient	7

FANS

CANDELIER

<small>NEW</small> Candelier II	10-11
---	-------

ORNATE

Victorian	14
19th Century	15
Alessandria	16
New Orleans Centennial	17
<small>NEW</small> Vicente	18
Barolo	19

TRADITIONAL

Panama	22-23
<small>NEW</small> Panama DC	24
<small>NEW</small> Panama Energy Star	25
Panama Halo	26-27
Four Seasons III	28-29
Four Seasons III Gallery	30-31
Concentra	32-33
Ventura	34-35

TRANSITIONAL

<small>NEW</small> Colorado	38
Veneto	39
Holliston	40-41
<small>NEW</small> Holliston DC	42
Siena	43
Academy	44-45
Academy Gallery	46-47
Whitman	48-49
Bel Air	50-51
Bel Air Halo	52-53
Capistrano	54-55
Metropolitan	56-57
Brescia	58-59

CONTEMPORARY

Stealth	62-63
<small>NEW</small> Stealth DC	64
<small>NEW</small> Bullet	65
<small>NEW</small> Antion	66
<small>NEW</small> Tercera	67
S3	68
Trident	69
Vita	70-71

Star	72
Starlet	73
Le Grande	74
Malibu Star	75
Modena II	76
Verrazano	77

LOW PROFILE

Isotope	80-81
Vermont	82
Silhouette II	83
Four Seasons III Hugger	84-85

DÉCOR SPECIFIC

Bungalow	88
Mission	89
Marrakesh	90-91
Cottage	92
Key Largo II	93
La Fleur	94
Wilderness	95

OUTDOOR / INDOOR

Heritage	98-99
Lanai	100-101
Cottage Wet	102
Panama Damp	103
Atria	104
Four Seasons III Outsider	105
Wailea	106-107
Estrada	108
Twain	109
Utopian	110
Continental	111

PORTABLE

Zephyr	114-115
------------------	---------

ACCESSORIES

Blades	118-123
Light Fixtures and Glass	124-131
Controls	132-133
Hanging System	134-135

SPECIFICATIONS

Finishes	136-137
Reference Charts	138-143

INDEX

Numerical	144
Alphabetical	145

THE WORLD'S FINEST CEILING FANS™

The Casablanca collection represents the successful synergy of elegance, versatility, efficiency, endurance and comfort. Each ceiling fan is created with an eye for timeless design, assembled with care from high-quality parts and engineered for superior energy efficiency to be a classic fixture in a home that is enjoyed for generations.



TERCERA™
See page 67 for details

WHAT'S NEW

Casablanca's latest introductions include 10 new ceiling fan collections in an array of timeless styles that will add a breath of fresh air to every room of your home – indoors and out!



VICENTE
See page 18 for details



ANTION
See page 66 for details



COLORADO
See page 38 for details



BULLET
See page 65 for details

QUALITY IN EVERY DETAIL™

Casablanca stands alone in its approach to the design, engineering and manufacturing of ceiling fans. We have made a long-term commitment to quality and invite you to compare the features of a Casablanca fan with any competitive product. Every detail is given meticulous attention – from design to components and manufacturing to ease of installation. Casablanca's attention to detail adds value to every fan, providing unprecedented performance for the life of your investment.

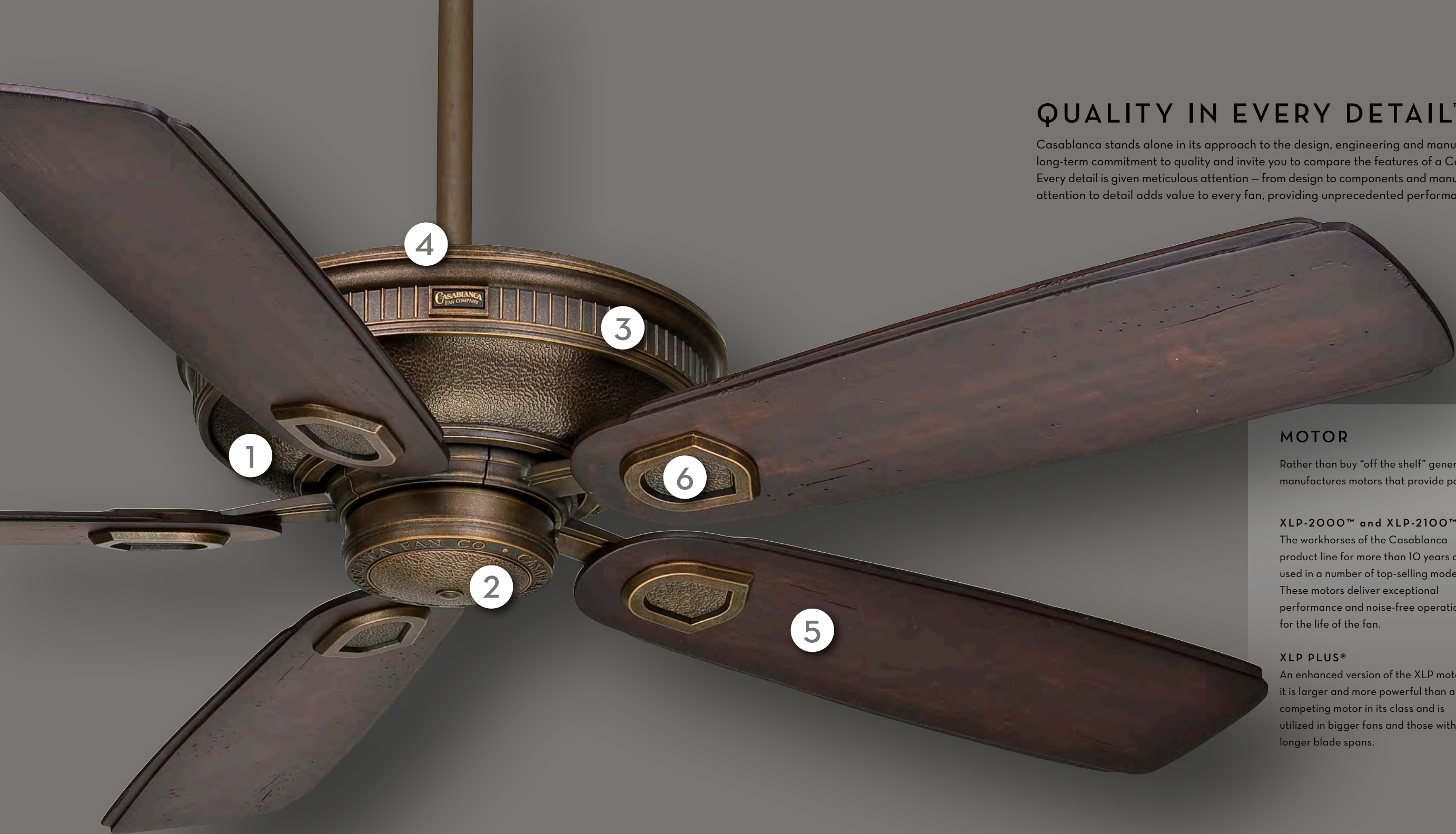

MOTOR

Rather than buy “off the shelf” generic motors, Casablanca designs, engineers, and manufactures motors that provide power and quiet operation for a variety of applications.

XLP-2000™ and XLP-2100™

The workhorses of the Casablanca product line for more than 10 years and used in a number of top-selling models. These motors deliver exceptional performance and noise-free operation for the life of the fan.

XLP PLUS®

An enhanced version of the XLP motor, it is larger and more powerful than any competing motor in its class and is utilized in bigger fans and those with longer blade spans.

XTR200™

Strikes the perfect balance between power and efficiency and is utilized on higher-end, indoor/outdoor models to provide maximum movement.

DIRECT DRIVE™

Designed and engineered for specific applications to work flawlessly for the life of the fan. Many Direct Drive™ models are ENERGY STAR® qualified.

DC

Don't let the size fool you. This high-efficiency permanent magnet direct current motor is extremely powerful. It's ENERGY STAR® qualified and four to five times more efficient than typical fan motors.

1 BOTTOM PLATE

The bottom plate encloses the lower part of the motor housing. Casablanca uses a variety of materials including solid die-cast virgin zinc, heavy-gauge deep-drawn steel, and structurally reinforced resin for enhanced beauty, protection, and quiet operation.

2 SWITCH HOUSING

The switch housing encloses primary fan controls. It features heavy-duty, die-cast virgin zinc or steel for exceptional durability. In addition, the exclusive design allows for easy installation of Casablanca light fixtures, providing a finished, integrated look.

3 MOTOR HOUSING

Casablanca offers die-cast and steel construction, for unmatched motor durability. The housing's plated or handpainted finish stays bright and beautiful throughout decades of use, with no more care required than dusting with a soft cloth.

4 PERMA-LOCK™

The Perma-Lock™ system connects the fan to the downrod. Casablanca's 3/4"-diameter Perma-Lock™ design provides improved appearance and stable connection. This works in perfect combination with the patented Hang-Tru® canopy. (See pages 134-135 for more details.)

5 BLADES

Unrivaled in the industry, Casablanca's blades are crafted with six layers of wood in a cross-laminated pattern and finished with two outer layers of real furniture-grade wood veneer for lasting beauty and durability. Some Casablanca fans feature carved wood blades for exceptional design detail.

6 BLADE HOLDERS

Casablanca's blade holders provide an essential link between blades and motor. The blade holders are made of heavy-duty, reinforced die-cast virgin zinc and are tested thoroughly for reliable performance.



EVERY CASABLANCA FAN IS BACKED BY 120-DAY IN-HOME SERVICE

Should your Casablanca fan not meet your satisfaction, we will send a trained representative to your home to service it. Simply call us at 1-800-715-0393 for referral to your local Authorized Service Center. If In-Home Service is not available in your area, Casablanca offers pre-paid freight to make it easy for you to send the fan to the Casablanca Factory Service Center. It will be repaired and returned to you at no charge.

Casablanca's Comprehensive Warranty, the most extensive in the ceiling fan industry, also includes:

LIFETIME MOTOR WARRANTY

All Casablanca fan motors, even on Damp- and Wet-rated models, are guaranteed for life.

ONE-YEAR PARTS AND ELECTRONICS WARRANTY

Each fan includes a one-year warranty on finish, component parts, accessories, and electronics.

With this extensive coverage, you can enjoy the beauty, quality, and performance of your Casablanca products for decades to come.



BEAUTY HAS NEVER BEEN SO EFFICIENT

Casablanca is dedicated to creating fans that work smarter, not harder, so that each element is fine-tuned to contribute to overall savings in energy costs. The powerful Casablanca motors move more cubic feet of air per minute (CFM) while using significantly less energy. Fan blades are set at the optimum pitch to provide maximum airflow at each speed setting. Even at the highest setting, each fan consumes about the same amount of power as a 100-watt light bulb.



Many Casablanca fans are ENERGY STAR® qualified and provide even greater energy efficiency (look for the ENERGY STAR logo throughout this catalog). Specific fan models are equipped with highly efficient compact fluorescent bulbs, and are California 24 compliant for maximum energy savings.

For your convenience, we've include this informational energy chart on every ceiling fan page:

Airflow: X,XXX cfm	Electricity Use: XX w	Airflow Efficiency: XX cfm/w
------------------------------	---------------------------------	--

*38" to 48" ceiling fans have airflow efficiencies ranging from approximately 71 to 86 cubic feet per minute per watt at high speed.
49" to 60" ceiling fans have airflow efficiencies ranging from approximately 51 to 176 cubic feet per minute per watt at high speed.*

MONEY SAVING TIP: Operating a fan in an empty room wastes energy, so turn it off when leaving the room.

CEILING FANS

CANDELIER

ORNATE

TRADITIONAL

TRANSITIONAL

CONTEMPORARY

LOW PROFILE

DÉCOR SPECIFIC

OUTDOOR / INDOOR



C16G73L
Oil-Rubbed Bronze fixture and motor with
Candelier Dark Walnut blades



CANDELIER™ II

Add the warm, intimate ambience of candlelight to a spacious room with the Candelier II ceiling fan. The fixture's ingenious design features 48 candles in varying heights and colors nestled around an Oil-Rubbed Bronze ring that houses a sleek, three-blade ceiling fan. Candles are fitted with LED bulbs that effectively capture the natural flickering motion and incandescent glow of real candles.



FEATURES

- XLP-2000™ motor / lifetime motor warranty
- 48" diameter / 30" blade span / 20° blade pitch
- Set of 3 exclusive Candelier Dark Walnut blades included
- Includes uplight with 48 LED flickering bulbs and 48 candles
- Includes eight 10-watt halogen downlights with bulbs
- Minimum 9' ceiling required
- Includes exclusive hanging system
- Low Ceiling Adapter (LCA) is not compatible
- Sloped Ceiling Adapter (SCA) is not compatible

CONTROL



Direct-Touch® (L)
W-74DL (included)
Four-speed wall control with full-range light dimming, reversing and CFL mode. Independent uplight and downlight operation.



Direct-Touch®
W-75DL (optional)
Four-speed remote control with full-range light dimming, reversing and CFL mode. Independent uplight and downlight operation.

DIMENSIONS

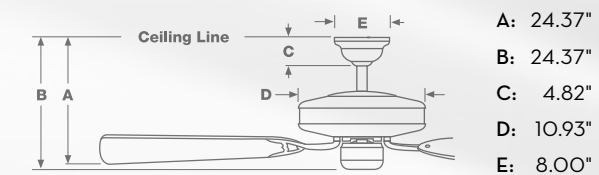

ENERGY INFORMATION AT HIGH SPEED

Airflow: 2,004 cfm	Electricity Use: 22 w	Airflow Efficiency: 90.3 cfm/w
-----------------------	--------------------------	-----------------------------------



NEW: Long-life LED flickering bulbs

CEILING FANS

CANDELIER

ORNATE

TRADITIONAL

TRANSITIONAL

CONTEMPORARY

LOW PROFILE

DÉCOR SPECIFIC

OUTDOOR / INDOOR



ORNATE

6344Z

Antique Brass motor shown with BB21-WD Dark Walnut blades, K164A-4 fitter with G911 Teck Antique side glass



6373Z
Oil-Rubbed Bronze motor shown with B103 Walnut blades



99U69Z

Burnished Brass motor with Mahogany blades and optional exclusive KG99A-69 light fixture



KG99A

19th Century Exclusive Four-Light CFL Fixture with Vianne Glass
56 watts
Available finishes:
Burnished Brass (-69)

Shown without light fixture



VICTORIAN®

This is where it all began...the original Casablanca fan. The Victorian series marries classic turn-of-the-century appeal with contemporary innovation and convenience. The richness of the ornate design is enhanced with badge-style blade holders. Optimum performance is achieved with a 15° blade pitch.



FEATURES

- XLP-2000™ motor / lifetime motor warranty
- 54" or 46" blade span / 15° blade pitch
- 4- or 5-blade configuration
- Multiple blade finish choices available (blades sold separately)

COMPATIBLE LIGHT FIXTURES

- Group A Light Fixtures (see pages 124-127)
- Group B Light Fixtures (see pages 127-129)

CONTROLS



Inteli-Touch3® (Z)
W-85 (included)
Six-speed wall control with full-range light dimming and reversing



Inteli-Touch3®
W-65 (optional)
Six-speed remote control with LCD display screen, full-range light dimming and reversing. Includes wall plate bracket.

DIMENSIONS

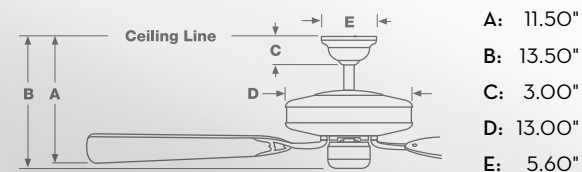

ENERGY INFORMATION AT HIGH SPEED

Airflow: 6,250 cfm	Electricity Use: 122 w	Airflow Efficiency: 51 cfm/w
------------------------------	----------------------------------	--



FEATURES

- XLP-2000™ motor / lifetime motor warranty
- 54" blade span / 14° blade pitch
- Set of 4 exclusive blades included
- Low Ceiling Adapter (LCA) is not compatible
- Requires additional hanging support (included)
- Minimum 9' ceiling required – uses 12" downrod (included)
- Extra-long downrods require outer sleeve (see pages 134-135)
- Decorative canopy cover may not be used if installed on a sloped ceiling or with a Sloped Ceiling Adapter (SCA)

CONTROLS



Inteli-Touch3® (Z)
W-85 (included)
Six-speed wall control with full-range light dimming and reversing



Inteli-Touch3®
W-65 (optional)
Six-speed remote control with LCD display screen, full-range light dimming and reversing. Includes wall plate bracket.

DIMENSIONS

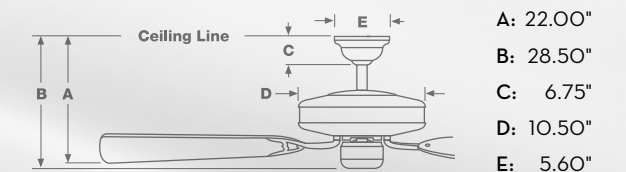

ENERGY INFORMATION AT HIGH SPEED

Airflow: 6,050 cfm	Electricity Use: 108 w	Airflow Efficiency: 56.2 cfm/w
------------------------------	----------------------------------	--

ORNATE



C27G546H
Brushed Cocoa motor with
Reclaimed Antique blades

C27G700H
Normandy motor with
Reclaimed Antique blades

ALESSANDRIA™

With a rich finish and exquisite detailing that echo the medallions and paneling of neoclassical architecture, the Alessandria ceiling fan is a timeless accent for the home. The fan's carved featherwood blades and fully dimmable lighting with Scavo glass add Old World warmth, elegance and comfort to interior settings.



FEATURES

- Direct Drive™ motor / lifetime motor warranty
- 54" blade span / 14° blade pitch
- Set of 5 exclusive carved featherwood blades included
- Integrated 75-watt uplight with five 15w bulbs included
- Integrated 100-watt downlight with two 50w T4 halogen bulbs included
- Low Ceiling Adapter (LCA) is not compatible

CONTROL

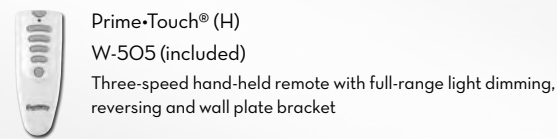

DIMENSIONS

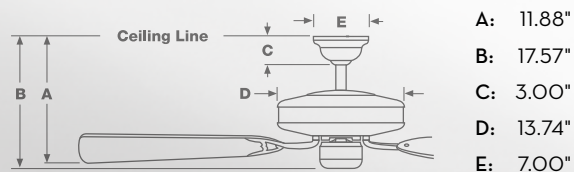

ENERGY INFORMATION AT HIGH SPEED

Airflow: 6,000 cfm	Electricity Use: 75 w	Airflow Efficiency: 80 cfm/w
------------------------------	---------------------------------	--

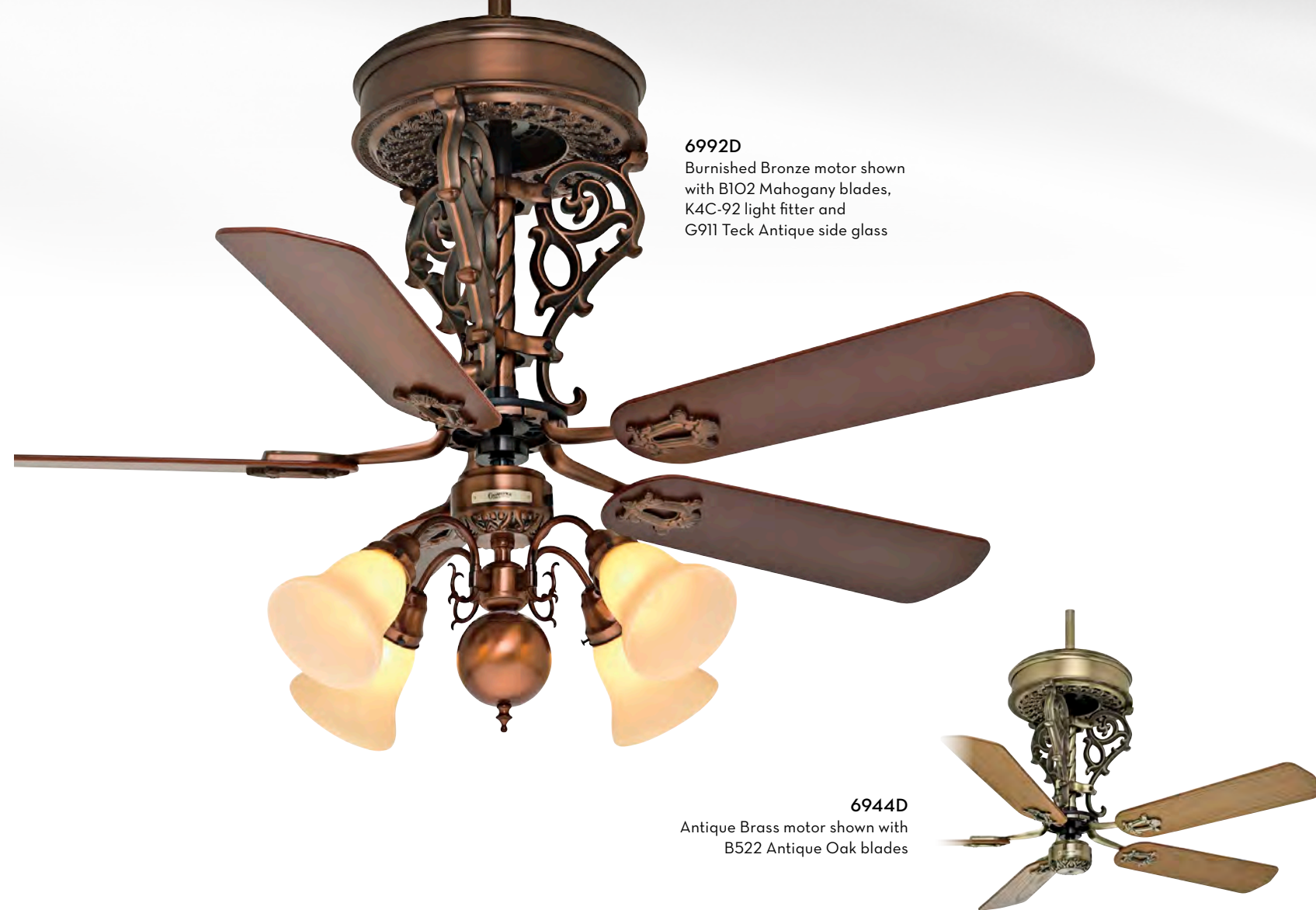

6992D
Burnished Bronze motor shown
with BIO2 Mahogany blades,
K4C-92 light fitter and
G911 Teck Antique side glass

6944D
Antique Brass motor shown with
B522 Antique Oak blades

NEW ORLEANS CENTENNIAL®

The New Orleans Centennial is a faithful replica of a 100-year old ceiling fan discovered in the French Quarter of New Orleans. The elaborate cast motor housing and lacy, scroll brackets recreate the wonderful ambience of a Southern parlor in a time gone by.



FEATURES

- XLP-2000™ motor / lifetime motor warranty
- 54" or 46" blade span / 15° blade pitch
- 4- or 5-blade configuration
- Multiple blade finish choices available (blades sold separately)
- Low Ceiling Adapter (LCA) is not compatible
- Minimum 10' ceiling required
- Requires additional hanging support (included)

COMPATIBLE LIGHT FIXTURES

- Group A Light Fixtures (see pages 124-127)
- Group B Light Fixtures (see pages 127-129)

CONTROLS



DIMENSIONS

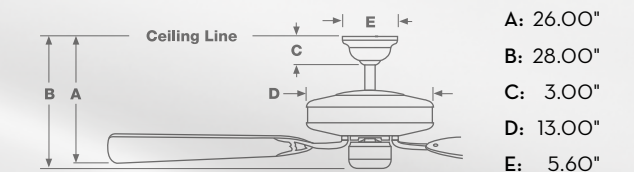

ENERGY INFORMATION AT HIGH SPEED

Airflow: 6,005 cfm	Electricity Use: 103 w	Airflow Efficiency: 58.1 cfm/w
------------------------------	----------------------------------	--

ORNATE



C32G611L
Northern Sienna motor
with Walnut blades

Shown without decorative
downrod accent as required
for mounting on 8' ceilings

VICENTE NEW

With the grandeur reminiscent of a beautiful Spanish fountain, or hermosa fuente, the Vicente makes a dramatic statement in even the largest rooms. When embellished with its decorative 13-inch downrod, its flourishes command your attention. But it's the fan's performance that holds you enthralled.



FEATURES

- Direct Drive™ motor / lifetime motor warranty
- 56" blade span / 15° blade pitch
- Set of 5 exclusive blades included
- Integrated 75-watt uplight with five 15w bulbs included
- Integrated 100-watt downlight with two 50w T4 halogen bulbs included
- 13" decorative and 5" standard downrods included
- Decorative downrod accent included
- Sloped Ceiling Adapter (SCA) is not compatible without part 19222OXX
- Low Ceiling Adapter (LCA) is not compatible

CONTROLS



Direct-Touch® (L)
W-74DL (included)
Four-speed wall control with full-range light dimming, reversing and CFL mode. Independent uplight and downlight operation.



Direct-Touch®
W-75DL (optional)
Four-speed remote control with full-range light dimming, reversing and CFL mode. Independent uplight and downlight operation.

DIMENSIONS

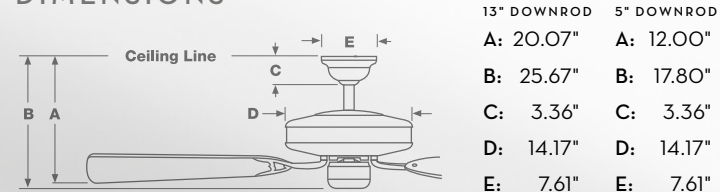

ENERGY INFORMATION AT HIGH SPEED

Airflow: 6,537 cfm	Electricity Use: 84 w	Airflow Efficiency: 77.9 cfm/w
------------------------------	---------------------------------	--



C5S63Z
Tuscan Sunset motor shown with
B103 Walnut blades and optional
exclusive KGC5-63 light fixture

KGC5
Barolo Exclusive
Three-Light
Center-Stem
Incandescent Fixture
with Amber Glass
180 watts (three 60w candelabra bulbs)
Available finishes:
Tuscan Sunset (-63) (Amber glass)

Shown without
light fixture

BAROLO®

With its artisan-quality craftsmanship, the Barolo ceiling fan is equally suited for an elegant villa or today's Mediterranean-style homes. The ornate hand-carved look and embossed grape motif housing conceal a powerful XLP-2000™ motor that is guaranteed for life.



FEATURES

- XLP-2000™ motor / lifetime motor warranty
- 52" or 44" blade span / 14° blade pitch
- 5-blade configuration
- Multiple blade finish choices available (blades sold separately)
- Includes matching no-light cap
- Requires additional hanging support (included)
- Low Ceiling Adapter (LCA) is not compatible

CONTROLS



Inteli-Touch3® (Z)
W-85 (included)
Six-speed wall control with full-range light dimming and reversing



Inteli-Touch3®
W-65 (optional)
Six-speed remote control with LCD display screen, full-range light dimming and reversing. Includes wall plate bracket.

DIMENSIONS

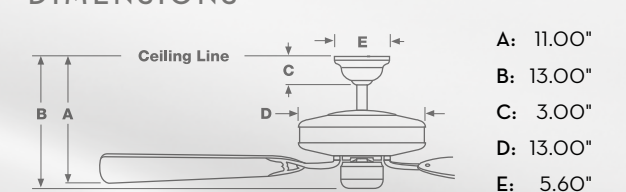

ENERGY INFORMATION AT HIGH SPEED

Airflow: 6,059 cfm	Electricity Use: 104 w	Airflow Efficiency: 58.2 cfm/w
------------------------------	----------------------------------	--

CEILING FANS

CANDELIER

ORNATE

TRADITIONAL

TRANSITIONAL

CONTEMPORARY

LOW PROFILE

DÉCOR SPECIFIC

OUTDOOR / INDOOR



TRADITIONAL



66668G/Z
Tuscan Bronze motor shown
with B515 Walnut blades

PANAMA®

The first five-bladed fan in the industry, the Panama is an American classic. The traditional styling works with virtually any setting. It's also one of the quietest ceiling fans available. Custom design your Panama by adding your choice of blades, light fixtures and glass. Define your personal style with 11 motor finish options.



FEATURES

- XLP-2000™ motor / lifetime motor warranty
- 50" or 42" blade span / 15° blade pitch
- 4- or 5-blade configuration
- Multiple blade finish choices available (blades sold separately)
- Offered with Intelli-Touch® six-speed control or 4-Speed pullchain
- ETL Damp-rated model available (see page 103)

COMPATIBLE LIGHT FIXTURES

- Group A Light Fixtures (see pages 124-127)
- Group B Light Fixtures (see pages 127-129)

CONTROLS

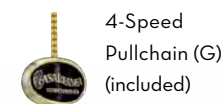

4-Speed
Pullchain (G)
(included)



Adapt-Touch™
W-52 (optional)
Three-speed remote control
with full-range light dimming.
Includes wall plate bracket.



Intelli-Touch3® (Z)
W-85 (included)
Six-speed wall control with
full-range light dimming
and reversing



Intelli-Touch3®
W-65 (optional)
Six-speed remote control with
LCD display screen, full-range
light dimming and reversing.
Includes wall plate bracket.

DIMENSIONS

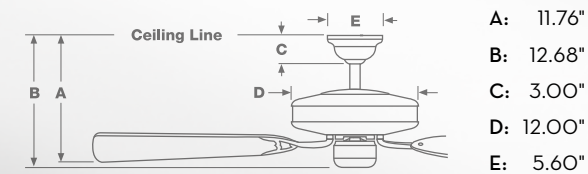

ENERGY INFORMATION AT HIGH SPEED

PANAMA XLP 4-SPEED

Airflow: 6,153 cfm	Electricity Use: 104 w	Airflow Efficiency: 59 cfm/w
------------------------------	----------------------------------	--

PANAMA INTELI-TOUCH

Airflow: 5,226 cfm	Electricity Use: 106 w	Airflow Efficiency: 49.3 cfm/w
------------------------------	----------------------------------	--

6611G/Z
Snow White motor
shown with
Matte Snow White blades



6622G/Z
Bright Brass motor
shown with
Walnut blades

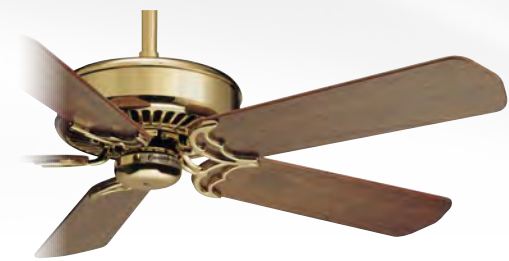

6632G/Z
Weathered Copper motor
shown with
Relic blades



6644G/Z
Antique Brass motor
shown with
Walnut blades

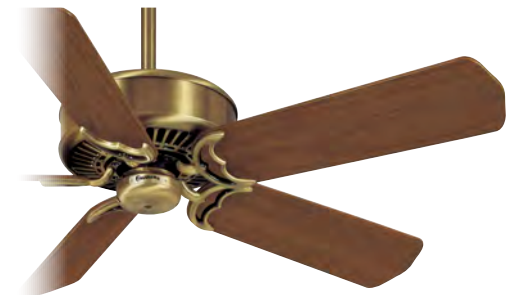

6645G/Z
Brushed Nickel motor
shown with
Mahogany blades



6672G/Z
Architectural White motor
shown with B204
Architecture White blades



6673G/Z
Oil-Rubbed Bronze motor
shown with
Dark Cherry blades



6688G/Z
Matte Black motor
shown with B588
Matte Black blades



6699G/Z
Classic White motor
shown with B537
Classic White blades



66546G/Z
Brushed Cocoa motor
shown with B521
Dark Walnut blades



TRADITIONAL



C66U546B
Brushed Cocoa motor with reversible Walnut / Burnt Walnut blades



C6611L
Snow White motor with Matte Snow White blades

C66U11B
Snow White motor with Matte Snow White blades



C66U45B
Brushed Nickel motor with Walnut / Burnt Walnut blades



C66546L
Brushed Cocoa motor with reversible Walnut / Burnt Walnut blades



C6645L
Brushed Nickel motor with Walnut / Burnt Walnut blades



PANAMA® DC NEW

A new spin on the original five-bladed fan, the Panama DC features a larger, 54-inch span and our extremely powerful DC motor. That means it can accommodate a larger room with higher efficiency—and it's ENERGY STAR-qualified. A new, true classic.



FEATURES

- DC motor / lifetime motor warranty
- 54" blade span / 15° blade pitch
- Set of 5 exclusive blades included

CONTROL

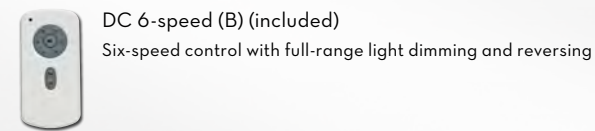

DIMENSIONS

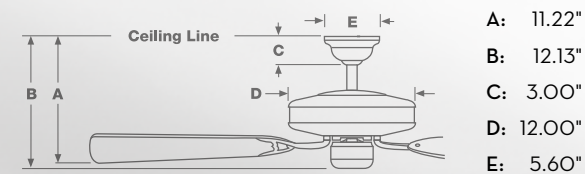

ENERGY INFORMATION AT HIGH SPEED

Airflow: 6,416 cfm	Electricity Use: 32 w	Airflow Efficiency: 199.3 cfm/w
------------------------------	---------------------------------	---

COMPATIBLE LIGHT FIXTURES

Group A Light Fixtures (see pages 124-127)
Group B Light Fixtures (see pages 127-129)

PANAMA® ENERGY STAR NEW

The tried-and-true ceiling fan now with a modern-day twist, our standard Panama design with Direct Drive™ motor is ENERGY STAR-qualified. It moves air up to 20 percent more efficiently, which helps you conserve energy, save money and protect the environment. Think that feels good? Wait until you turn it on.



FEATURES

- Direct Drive™ motor / lifetime motor warranty
- 50" or 42" blade span / 15° blade pitch
- 4- or 5-blade configuration
- Multiple blade finish choices available (blades sold separately)

COMPATIBLE LIGHT FIXTURES

Group A Light Fixtures (see pages 124-127)
Group B Light Fixtures (see pages 127-129)

CONTROLS



DIMENSIONS

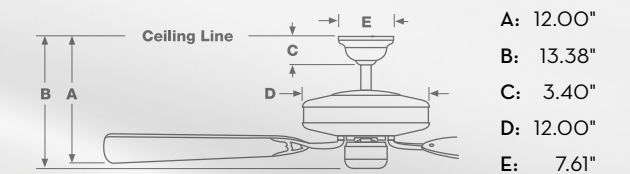

ENERGY INFORMATION AT HIGH SPEED

Airflow: 6,238 cfm	Electricity Use: 83 w	Airflow Efficiency: 75.2 cfm/w
------------------------------	---------------------------------	--

TRADITIONAL



66H11F
Snow White motor shown with
B561 Matte Snow White blades



66H73F
Oil-Rubbed Bronze motor shown with
B206 Dark Cherry blades, K44TA-73
four-light fitter and CSG2 Amber
Speckled Scavo side glass



66H45F
Brushed Nickel motor shown with B562
Teak blades, K2CA-45 integrated
incandescent fitter and G108
low-profile glass

PANAMA® HALO

With its traditional styling and subtle halo uplight, the Panama Halo ceiling fan casts a new light on an American classic. Its integrated halo uplight comes with incandescent bulbs that burn at ultra-cool temperatures for maximum energy efficiency.



FEATURES

- XTR200™ motor / lifetime motor warranty
- 50" or 42" blade span / 20° blade pitch
- 5-blade configuration
- Multiple blade finish choices available (blades sold separately)
- Includes 45-watt halo uplight with incandescent bulbs (44,000-hour bulb life)
- Low Ceiling Adapter (LCA) is not compatible

COMPATIBLE LIGHT FIXTURES

- Group A Light Fixtures (see pages 124-127)
- Group B Light Fixtures (see pages 127-129)

CONTROLS

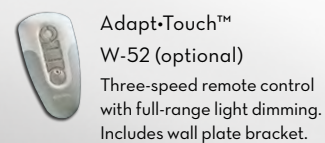
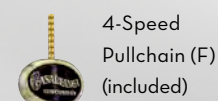

DIMENSIONS

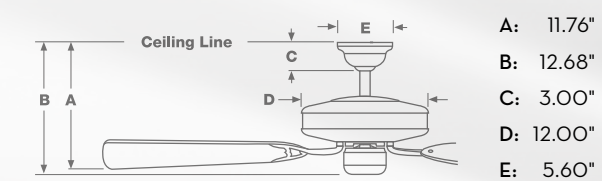

ENERGY INFORMATION AT HIGH SPEED

Airflow: 6,522 cfm	Electricity Use: 82 w	Airflow Efficiency: 79.5 cfm/w
------------------------------	---------------------------------	--

The ultra-cool-burning uplight fixture allows close-to-ceiling installation.



TRADITIONAL

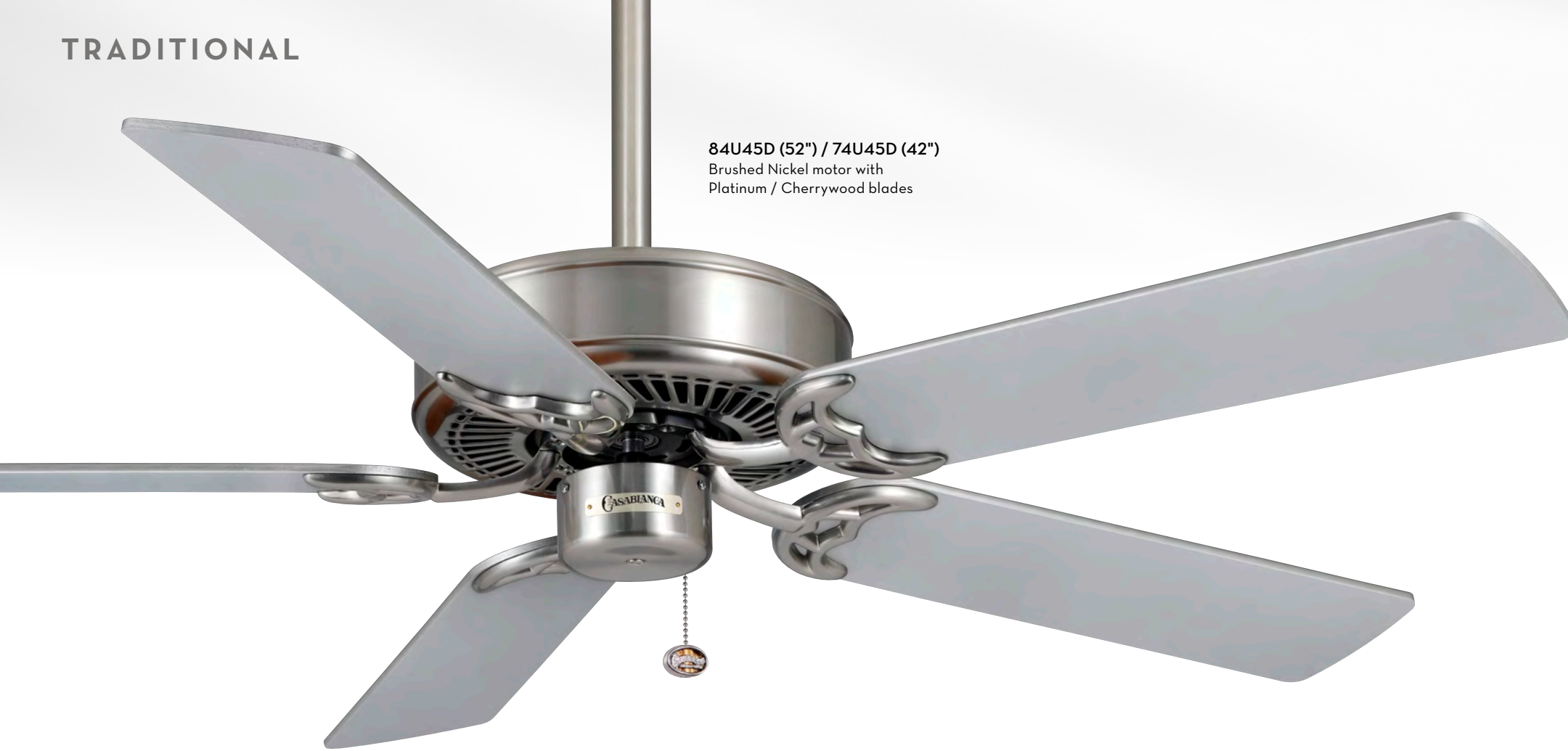

84U45D (52") / 74U45D (42")
Brushed Nickel motor with
Platinum / Cherrywood blades

84U11D (52") / 74U11D (42")
Snow White motor
with Snow White /
Bleached Oak blades



84U73D (52") / 74U73D (42")
Oil-Rubbed Bronze motor
with Walnut /
Antique Oak blades

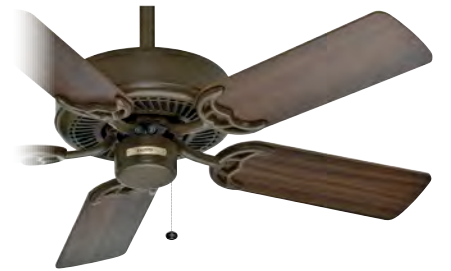

84U4D (52")
Antique Brass motor
with Antique Oak /
Bleached Oak blades



FOUR SEASONS® III

Casablanca quality, excellent value, and luxury of finish and control choice make the Four Seasons III the best ceiling fan in its class. Traditional in styling, this versatile fan offers selection and features worthy of the Casablanca name.



FEATURES

- Direct Drive™ motor / lifetime motor warranty
- 52" or 42" blade span / 13° blade pitch
- Set of 5 reversible blades included
- ETL Damp-rated model available (see page 105)

COMPATIBLE LIGHT FIXTURES

Group B Light Fixtures (see pages 127-129)

CONTROLS

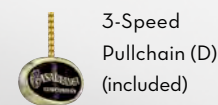

3-Speed
Pullchain (D)
(included)



WRF3-XX
(optional)
Three-speed remote control
with full-range light dimming
and reversing



Adapt-Touch™
W-52 (optional)
Three-speed remote control
with full-range light dimming.
Includes wall plate bracket.

Note: Must use accessory control to operate accessory light fixtures without a pullchain.

DIMENSIONS

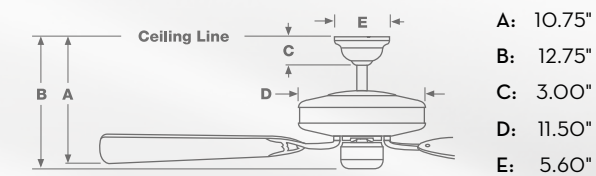

ENERGY INFORMATION AT HIGH SPEED

52" BLADE	42" BLADE
Airflow: 5,114 cfm	Airflow: 4,134 cfm
Electricity Use: 68 w	Electricity Use: 59.5 w
Airflow Efficiency: 74.3 cfm/w	Airflow Efficiency: 69.5 cfm/w

84U9D (52")
Classic White motor
with Classic White /
Bleached Oak blades



84U72D (52")
Architectural White motor
with Architectural White /
Bleached Oak blades



TRADITIONAL



84G73D
Oil-Rubbed Bronze motor with
Dark Walnut / Teak blades



84G11D
Snow White motor
with Bleached Oak /
Matte Snow White blades



84G45D
Brushed Nickel motor
with Dark Walnut /
Mahogany blades

FOUR SEASONS® III GALLERY

With its integrated bowl light fixture, the value-added Four Seasons III Gallery fan brings illumination as well as comfort to interior settings. Reversible blades double your decorative options.



FEATURES

- Direct Drive™ motor / lifetime motor warranty
- 52" blade span / 13° blade pitch
- Set of 5 reversible blades included
- Includes 120-watt incandescent downlight with three 40w bulbs

CONTROLS

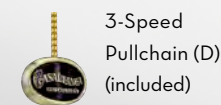

3-Speed
Pullchain (D)
(included)



Adapt-Touch™
W-52 (optional)
Three-speed remote control
with full-range light dimming.
Includes wall plate bracket.

DIMENSIONS

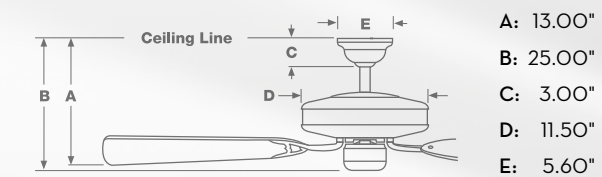

ENERGY INFORMATION AT HIGH SPEED

Airflow: 5,100 cfm	Electricity Use: 80 w	Airflow Efficiency: 63.8 cfm/w
------------------------------	---------------------------------	--

TRADITIONAL



49546D
Brushed Cocoa motor shown
with B515 Walnut blades

4911D
Snow White motor shown
with B561 Matte Snow White blades



4999D
Classic White motor shown
with B537 Classic White blades



4973D
Oil-Rubbed Bronze motor shown
with B562 Teak blades



CONCENTRA™

Casablanca's hallmark of quality and performance continues with this fan. The Concentra features a fresh design well-suited for both traditional and transitional room settings.



see accessories
page 118 for
blade options

FEATURES

- Direct Drive™ motor / lifetime motor warranty
- 50" or 42" blade span / 16° blade pitch
- 5-blade configuration
- Multiple blade finish choices available (blades sold separately)

CONTROLS



3-Speed
Pullchain (D)
(included)



Adapt-Touch™
W-52 (optional)
Three-speed remote control
with full-range light dimming.
Includes wall plate bracket.

DIMENSIONS

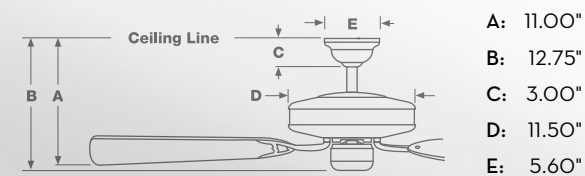

ENERGY INFORMATION AT HIGH SPEED

Airflow: 6,727 cfm	Electricity Use: 89 w	Airflow Efficiency: 75.8 cfm/w
------------------------------	---------------------------------	--

4944D
Antique Brass motor shown with B206 Dark
Cherry blades, K2AA
fitter and G220
Italian textured glass



4945D
Brushed Nickel motor shown
with B201 Maple blades



4972D
Architectural White
motor shown with
B204 Architectural
White blades



4988D
Matte Black motor shown
with B588 Matte Black blades



TRADITIONAL

6744D
Antique Brass motor shown with B28S-TK
Teak Carved Wood South Seas blades



6745D
Brushed Nickel motor shown
with White Avalon blades

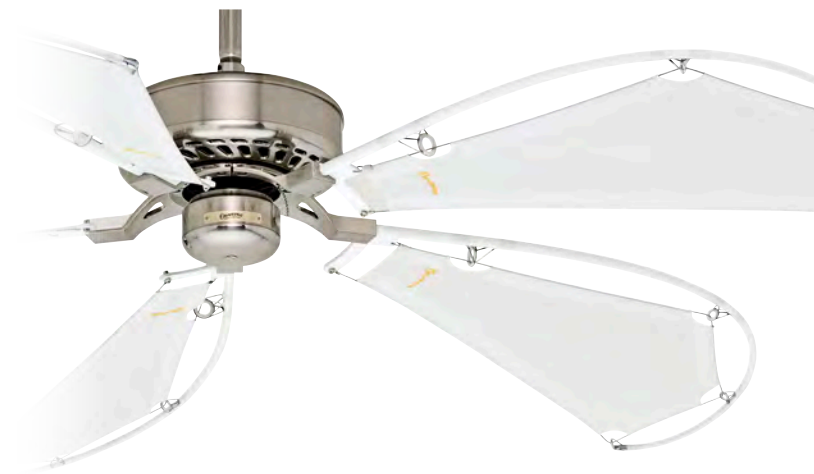

6711D
Snow White motor shown
with Matte Snow White blades



VENTURA™

Looking for versatility? Look no further than the Ventura. The style is clean, simple and practical, and will work just about anywhere.



STANDARD sold separately see accessories page 118 for blade options

FEATURES

- XLP-2000™ motor / lifetime motor warranty
- 42", 50" (with South Seas blades) or 62" (with Avalon blades) blade span
- 16° blade pitch
- 5-blade configuration
- Multiple blade finish choices available (blades sold separately)

COMPATIBLE LIGHT FIXTURES

- Group A Light Fixtures (see pages 124-127)
- Group B Light Fixtures (see pages 127-129)

CONTROLS

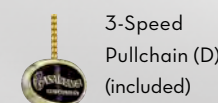

3-Speed Pullchain (D) (included)



Adapt-Touch™ W-52 (optional)
Three-speed remote control with full-range light dimming. Includes wall plate bracket.

DIMENSIONS

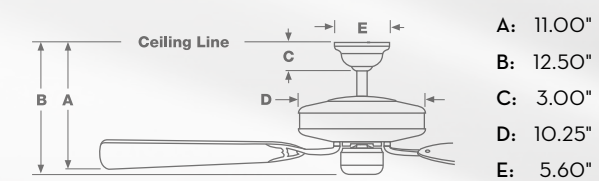

ENERGY INFORMATION AT HIGH SPEED

Airflow: 6,105 cfm	Electricity Use: 106 w	Airflow Efficiency: 57.8 cfm/w
------------------------------	----------------------------------	--

CEILING FANS

CANDELIER

ORNATE

TRADITIONAL

TRANSITIONAL

CONTEMPORARY

LOW PROFILE

DÉCOR SPECIFIC

OUTDOOR / INDOOR



Holliston™ ceiling fan

TRANSITIONAL



C42G45L
Brushed Nickel motor with
Walnut / Burnt Walnut blades



C42G546L
Brushed Cocoa motor shown with
Walnut / Burnt Walnut blades



C15G624L
Bullion Black motor with Espresso blades
and Gold Dust glass bowl fixtures

COLORADO NEW

Inspired by the state known for its snow-capped summits and vast blue skies, the natural beauty Colorado is fittingly at home in large rooms with 9-foot ceilings or higher. Sixty-inch veneer blades and a full-function wall control also put this majestic fan at the peak of value.



FEATURES

- Direct Drive™ motor / lifetime motor warranty
- 60" blade span / 14° blade pitch
- Set of 5 exclusive blades included
- Includes 26-watt medium-base CFL downlight
- Minimum 9' ceiling required

CONTROLS



Direct-Touch® (L)
W-74SL (included)
Four-speed wall control with
full-range light dimming,
reversing and CFL mode



Direct-Touch®
W-75SL (optional)
Four-speed remote control
with full-range light dimming,
reversing and CFL mode

DIMENSIONS

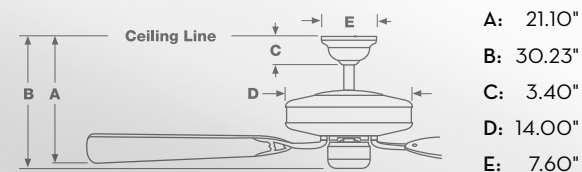

ENERGY INFORMATION AT HIGH SPEED

Airflow: 6,944 cfm	Electricity Use: 94 w	Airflow Efficiency: 74.2 cfm/w
------------------------------	---------------------------------	--

VENETO®

This elegant fan says "Benvenuto" to every person who encounters its distinctive warmth. With a rich Bullion Black finish and hand-crafted fluted glass, the Veneto gives your great room a touch of Italy, no matter where you live.



FEATURES

- Direct Drive™ motor / lifetime motor warranty
- 68" blade span / 13° blade pitch
- Set of 5 exclusive blades included
- Integrated 90-watt uplight with six 15w bulbs included
- Integrated 120-watt downlight with three 40w bulbs included
- Minimum 9' ceiling required
- Requires additional hanging support (included)
- Low Ceiling Adapter (LCA) is not compatible

CONTROLS



Direct-Touch® (L)
W-74DL (included)
Four-speed wall control with
full-range light dimming,
reversing and CFL mode.
Independent uplight and
downlight operation.



Direct-Touch®
W-75DL (optional)
Four-speed remote control
with full-range light dimming,
reversing and CFL mode.
Independent uplight and
downlight operation.

DIMENSIONS

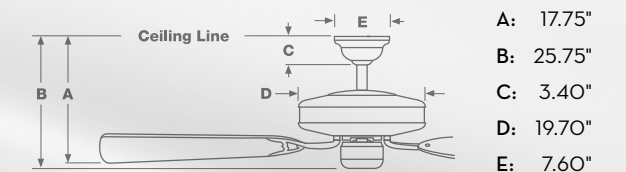

ENERGY INFORMATION AT HIGH SPEED

Airflow: 7,296 cfm	Electricity Use: 101 w	Airflow Efficiency: 73 cfm/w
------------------------------	----------------------------------	--

TRANSITIONAL



C31U624Z
Bullion Black motor with Reclaimed Antique blades, shown with KGC12A-624 four-light fixture



C31U11Z
Snow White motor with Hi-Gloss Snow White blades, shown with K4SA-11 four-light fitter and G917 White Satin side glass

HOLLISTON™

The Holliston ceiling fan combines classic style with ultimate performance and convenience. The next-generation XLP Plus® motor, accented with a custom-designed canopy and halo uplight, is controlled via radio frequency with Casablanca's new Intelli-Touch3® wall control.



FEATURES

- XLP Plus® motor / lifetime motor warranty
- 60" blade span / 15° blade pitch
- Set of 5 exclusive blades included
- Integrated 42-watt incandescent uplight with bulbs included
- Includes decorative canopy cover
- Sloped Ceiling Adapter (SCA) is not compatible without part 192220XX (see pages 134-135)
- Low Ceiling Adapter (LCA) is not compatible

COMPATIBLE LIGHT FIXTURES

- Group A Light Fixtures (see pages 124-127)
- Group B Light Fixtures (see pages 127-129)

CONTROLS

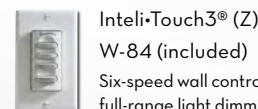

Intelli-Touch3® (Z) W-84 (included)
Six-speed wall control with full-range light dimming and reversing. Independent uplight and downlight operation.



Intelli-Touch3® W-64 (optional)
Six-speed remote control with LCD display screen, full-range light dimming and reversing. Independent uplight and downlight operation. Includes wall plate bracket.

DIMENSIONS

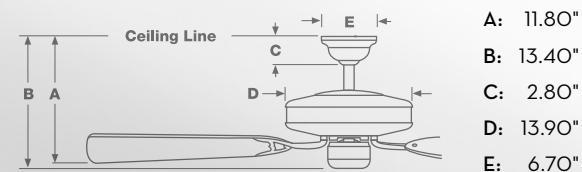

ENERGY INFORMATION AT HIGH SPEED

Airflow: 6,494 cfm	Electricity Use: 115 w	Airflow Efficiency: 56 cfm/w
------------------------------	----------------------------------	--

C31U97Z
Antique Pewter motor with Dark Walnut blades



C31U45Z
Brushed Nickel motor with Clove blades



C31U199Z
Chrome motor with Espresso blades



C31U73Z
Oil-Rubbed Bronze motor with Walnut blades



TRANSITIONAL

C31U45B
Brushed Nickel motor with reversible Walnut / Burnt Walnut blades



C31U11B
Snow White motor shown with Matte Snow White blades



C31U546B
Brushed Cocoa motor shown with reversible Walnut / Burnt Walnut blades



HOLLISTON™ DC NEW

Truly, the Holliston DC is a finely detailed fan with big-picture perspective. Ideal for large rooms, our new DC motor makes it one of the quietest, most energy-efficient fans available. So you conserve energy, save money and help protect the environment—staying comfortable all the while.



FEATURES

- DC motor / lifetime motor warranty
- 60" blade span / 15° blade pitch
- Set of 5 exclusive blades included
- Includes decorative canopy cover
- Sloped Ceiling Adapter (SCA) is not compatible without part 19222OXX (see pages 134-135)
- Low Ceiling Adapter (LCA) is not compatible

COMPATIBLE LIGHT FIXTURES

Group A Light Fixtures (see pages 124-127)

Group B Light Fixtures (see pages 127-129)

CONTROL

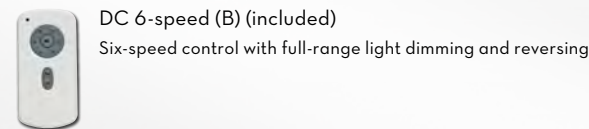

DIMENSIONS

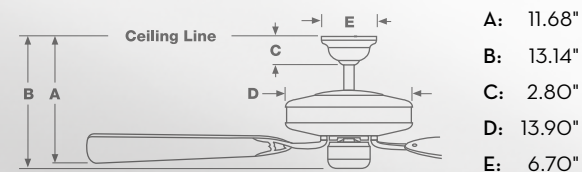

ENERGY INFORMATION AT HIGH SPEED

Airflow: 7,087 cfm	Electricity Use: 30.8 w	Airflow Efficiency: 230 cfm/w
------------------------------	-----------------------------------	---

P5G73M
Oil-Rubbed Bronze motor with reversible Burnt Relic / Burnt Cherry blades, Scavo glass uplight and three-light torch-style fixture



The no-light finial features decorative scrollwork. Pictured with Burnt Cherry blade finish.



SIENA®

The hand-wrought design and artisan-quality workmanship made famous by the fabled city of Siena are brought to today's interiors with its namesake ceiling fan. The Siena fan marries the beauty of natural materials with a tradition of quality built to last for generations.



FEATURES

- Direct Drive™ motor / lifetime motor warranty
- 54" blade span / 15° blade pitch
- Set of 5 custom reversible blades included
- Integrated 120-watt uplight with three 40w bulbs included
- Integrated 180-watt downlight with three 60w bulbs included
- Uplight and downlight can be controlled independently
- Optional decorative no-light finial included
- 9" decorative and 3" standard downrods included
- Requires additional hanging support (included)

CONTROL

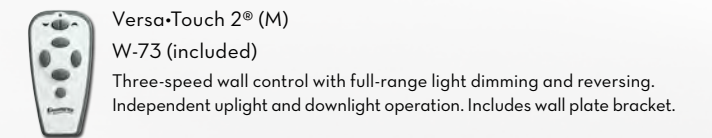

DIMENSIONS

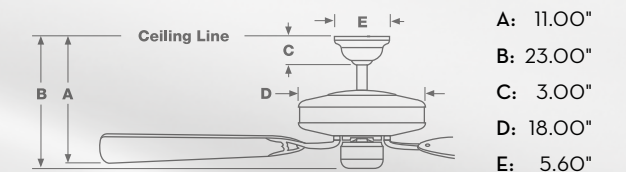

ENERGY INFORMATION AT HIGH SPEED

Airflow: 4,680 cfm	Electricity Use: 67 w	Airflow Efficiency: 69.7 cfm/w
------------------------------	---------------------------------	--

TRANSITIONAL



C38U199K
Chrome motor with reversible
Espresso / Walnut blades



C38U11K
Snow White motor with
Snow White blades



C38U45K
Brushed Nickel motor with
reversible Clove / Dark Walnut blades

ACADEMY

The smart-looking Academy teaches an important lesson in design flexibility. Its transitional styling combined with a wide selection of finish options make this ceiling fan a scholarly choice for living rooms, great rooms, bedrooms or almost any room in the house.



FEATURES

- Direct Drive™ motor / lifetime motor warranty
- 54" blade span / 14° blade pitch
- Set of 5 exclusive blades included
- Die-cast metal bottom cap
- Sloped Ceiling Adapter (SCA) is not compatible without part 192220XX (see pages 134-135)
- Low Ceiling Adapter (LCA) is not compatible

COMPATIBLE LIGHT FIXTURES

Group A Light Fixtures (see pages 124-127)

CONTROLS



4-Speed
Pullchain (K)
(included)



Adapt-Touch™
W-52 (optional)
Three-speed remote control
with full-range light dimming.
Includes wall plate bracket.



C38U73K
Oil-Rubbed Bronze motor with
reversible Walnut / Dark Walnut blades

DIMENSIONS

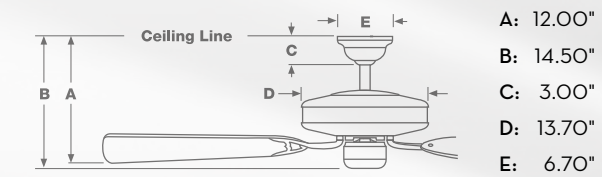

ENERGY INFORMATION AT HIGH SPEED

Airflow: 5,878 cfm	Electricity Use: 75 w	Airflow Efficiency: 79 cfm/w
------------------------------	---------------------------------	--

TRANSITIONAL



C38G73K
Oil-Rubbed Bronze motor with reversible Walnut / Dark Walnut blades



C38G199K
Chrome motor shown with reversible Espresso / Walnut blades



C38G45K
Brushed Nickel motor with reversible Clove / Dark Walnut blades



C38G11K
Snow White motor with Snow White blades

ACADEMY GALLERY

Talk about your overachievers. The Academy Gallery takes honors for best all-around with transitional styling, a wide selection of finish options and an integrated light bowl fixture.



FEATURES

- Direct Drive™ motor / lifetime motor warranty
- 54" blade span / 14° blade pitch
- Set of 5 exclusive blades included
- Integrated 120-watt downlight with three 40w bulbs included
- Low Ceiling Adapter (LCA) is not compatible

CONTROLS

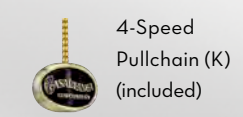

4-Speed Pullchain (K) (included)



Adapt-Touch™ W-52 (optional) Three-speed remote control with full-range light dimming. Includes wall plate bracket.

DIMENSIONS

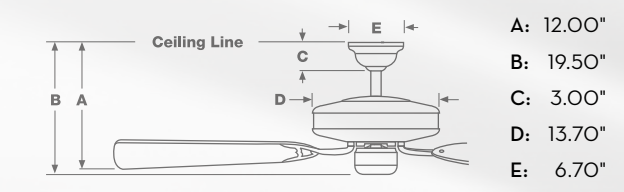

- A: 12.00"
- B: 19.50"
- C: 3.00"
- D: 13.70"
- E: 6.70"

ENERGY INFORMATION AT HIGH SPEED

Airflow: 5,878 cfm	Electricity Use: 75 w	Airflow Efficiency: 79 cfm/w
------------------------------	---------------------------------	--

TRANSITIONAL



C21G546H
Brushed Cocoa motor with Walnut blades



C21G45H
Brushed Nickel motor with Dark Cherry blades



C21G97H
Antique Pewter motor with Rosewood blades



C21G667H
Cherry Bronze motor with Reclaimed Antique blades

WHITMAN™

With its versatile design and quality craftsmanship, the Whitman ceiling fan brings year-round comfort and seamless performance to almost any room in the home. The fan incorporates carved featherwood blades reminiscent of the woodwork on fine cabinetry and a fully dimmable uplight and downlight that add gentle ambience.



FEATURES

- Direct Drive™ motor / lifetime motor warranty
- 54" blade span / 14° blade pitch
- Set of 5 exclusive carved featherwood blades included
- Integrated 75-watt incandescent uplight with five 15w bulbs included
- Integrated 100-watt downlight with two 50w T4 halogen bulbs included
- Low Ceiling Adapter (LCA) is not compatible

CONTROL



Prime-Touch® (H)
W-505 (included)
Three-speed hand-held remote with full-range light dimming, reversing and wall plate bracket

DIMENSIONS

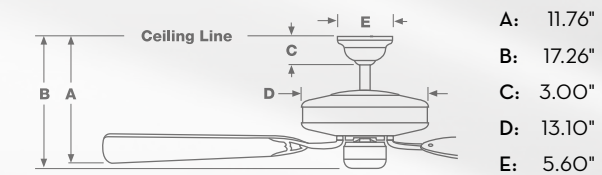

ENERGY INFORMATION AT HIGH SPEED

Airflow: 5,627 cfm	Electricity Use: 70 w	Airflow Efficiency: 80.4 cfm/w
------------------------------	---------------------------------	--

Note: Glass on model C21G546H will change to Amber during 2011.

TRANSITIONAL



3845Z
Brushed Nickel motor shown with
B615 Hi-Gloss Cherrywood blades

3811Z
Snow White motor shown with
B611 Hi-Gloss Snow White blades



3832Z
Weathered Copper motor shown with
Mahogany blades



3873Z
Oil-Rubbed Bronze motor shown with
Dark Cherry blades



38546Z
Brushed Cocoa motor shown with
Walnut blades



BEL AIR®

The popular Bel Air is the essence of Casablanca beauty. The housing and halogen light form a design continuum, helping to create a compelling and sophisticated presence. Uniquely cast blade holders lend a classic yet traditional look.



FEATURES

- XLP-2000™ motor / lifetime motor warranty
- 55" blade span / 14° blade pitch
- 5-blade configuration (exclusive blades sold separately)
- Integrated 100-watt downlight with one T4 halogen bulb included
- Low Ceiling Adapter (LCA) is not compatible

EXCLUSIVE BLADE OPTIONS

- | | |
|--------------------------|------------------|
| B611 Hi-Gloss Snow White | B619 Dark Cherry |
| B615 Hi-Gloss Cherrywood | B621 Dark Walnut |
| B618 Mahogany | B622 Walnut |

CONTROLS



Intelli-Touch3® (Z)
W-85 (included)
Six-speed wall control with
full-range light dimming
and reversing



Intelli-Touch3®
W-65 (optional)
Six-speed remote control with
LCD display screen, full-range
light dimming and reversing.
Includes wall plate bracket.

DIMENSIONS

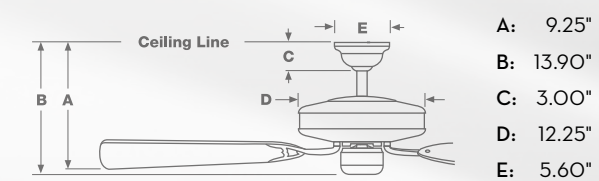

ENERGY INFORMATION AT HIGH SPEED

Airflow: 7,174 cfm	Electricity Use: 119 w	Airflow Efficiency: 60.5 cfm/w
------------------------------	----------------------------------	--

TRANSITIONAL



38DH546Z
Brushed Cocoa motor shown with
B621 Dark Walnut blades



38DH45Z
Brushed Nickel motor shown with
B615 Hi-Gloss Cherrywood blades



38DH73Z
Oil-Rubbed Bronze motor shown
with B619 Dark Cherry blades

BEL AIR® HALO

Inspired by Casablanca's original Bel Air ceiling fan, the Bel Air Halo is one of Casablanca's most elegant offerings. Projecting a warm glow onto the ceiling, it creates a mood of subtle sophistication. The addition of rope detailing adds further refinement to this stunning fan.



FEATURES

- XLP-2000™ motor / lifetime motor warranty
- 55" blade span / 14° blade pitch
- 5-blade configuration (exclusive blades sold separately)
- Integrated 180-watt halo uplight and 100-watt halogen downlight with bulbs included
- Uplight and downlight can be controlled independently
- Low Ceiling Adapter (LCA) is not compatible
- Minimum 9' ceiling required
- Requires additional hanging support (included)

EXCLUSIVE BLADE OPTIONS

- | | |
|--------------------------|------------------|
| B611 Hi-Gloss Snow White | B619 Dark Cherry |
| B615 Hi-Gloss Cherrywood | B621 Dark Walnut |
| B618 Mahogany | B622 Walnut |

CONTROLS



Intelli-Touch3® (Z)
W-84 (included)
Six-speed wall control with full-range light dimming and reversing. Independent uplight and downlight operation.



Intelli-Touch3®
W-64 (optional)
Six-speed remote control with LCD display screen, full-range light dimming and reversing. Independent uplight and downlight operation. Includes wall plate bracket.

DIMENSIONS

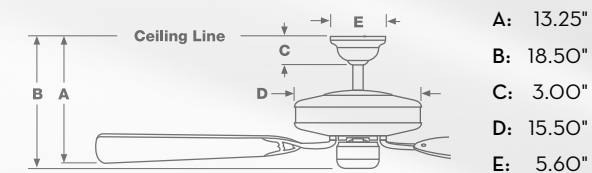

ENERGY INFORMATION AT HIGH SPEED

Airflow: 7,174 cfm	Electricity Use: 119 w	Airflow Efficiency: 60.5 cfm/w
------------------------------	----------------------------------	--

TRANSITIONAL



46U11D/M
Snow White motor with reversible Hi-Gloss
Snow White / Matte Snow White blades

46U546D/M
Brushed Cocoa motor with reversible
Dark Walnut / Walnut blades



46U45D/M
Brushed Nickel motor with reversible
Mahogany / Dark Walnut blades



46U4D/M
Antique Brass motor with reversible
Walnut / Medium Oak blades

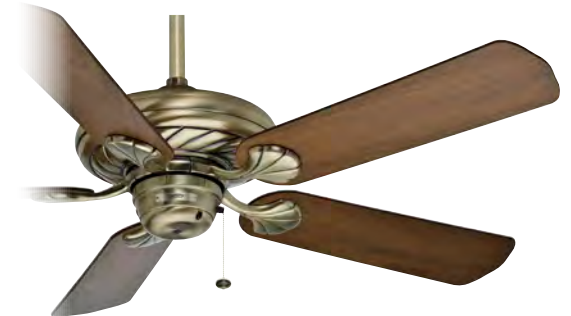

CAPISTRANO®

Subtle sophistication is a dominant theme in today's decor. Nothing complements this attitude like the Capistrano, with a soft, sculpted look and the nautical suggestion of seashells.



FEATURES

- Direct Drive™ motor / lifetime motor warranty
- 53" blade span
- 16° blade pitch
- Set of 5 reversible blades included

COMPATIBLE LIGHT FIXTURES

- Group A Light Fixtures (see pages 124-127)
- Group B Light Fixtures (see pages 127-129)

CONTROLS

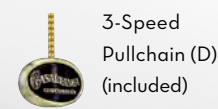

3-Speed
Pullchain (D)
(included)



Adapt-Touch™
W-52 (optional)
Three-speed remote control
with full-range light dimming.
Includes wall plate bracket.



Versa-Touch 2® (M)
W-73 (included)
Three-speed wall control with full-range light dimming and reversing.
Includes wall plate bracket.

DIMENSIONS

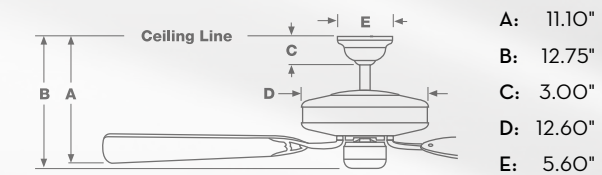

ENERGY INFORMATION AT HIGH SPEED

Airflow: 6,691 cfm	Electricity Use: 89 w	Airflow Efficiency: 75.2 cfm/w
------------------------------	---------------------------------	--

46U26D/M
Navajo White motor with reversible
Teak / Dark Cherry blades



46U73D/M
Oil-Rubbed Bronze
motor with reversible
Teak / Dark Cherry blades



TRANSITIONAL



6444Z
Antique Brass motor shown with B513 Hi-Gloss Walnut blades



6411Z
Snow White motor shown with B511 Hi-Gloss Snow White blades, K1CA-II halogen light fitter and G110 Opal glass



6445Z
Brushed Nickel motor shown with B508 Matte Black blades, K134A-45 three-light fitter and G917 White Satin side glass

METROPOLITAN™

A deeply sculpted die-cast housing accented by bold, round blade badges gives the Metropolitan its fresh, progressive look.



FEATURES

- XLP-2000™ motor / lifetime motor warranty
- 52" or 44" blade span / 15° blade pitch
- 4- or 5-blade configuration
- Multiple blade finish choices available (blades sold separately)

CONTROLS



Inteli-Touch3® (Z)
W-85 (included)
Six-speed wall control with full-range light dimming and reversing



Inteli-Touch3®
W-65 (optional)
Six-speed remote control with LCD display screen, full-range light dimming and reversing. Includes wall plate bracket.

DIMENSIONS

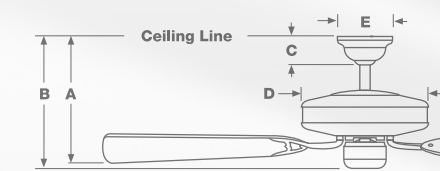

- A: 12.00"
- B: 12.20"
- C: 3.00"
- D: 12.00"
- E: 5.60"

COMPATIBLE LIGHT FIXTURES

Group A Light Fixtures (see pages 124-127)

Group B Light Fixtures (see pages 127-129)

ENERGY INFORMATION AT HIGH SPEED

Airflow: 6,003 cfm	Electricity Use: 119 w	Airflow Efficiency: 50.5 cfm/w
------------------------------	----------------------------------	--

TRANSITIONAL

9532Z

Weathered Copper motor shown with BB21-WD Dark Walnut blades, shown with optional exclusive KGIN mica light fixture



KGIN

Brescia Exclusive
Incandescent Mica Fixture
180 watts (three 60w candelabra bulbs)
Available finishes:
Weathered Copper (-32)
Brushed Nickel (-45)
Brushed Cocoa (-546)

95546D/Z
Brushed Cocoa motor shown with B111 Relic blades



9545Z
Brushed Nickel motor shown with B507 Teak blades

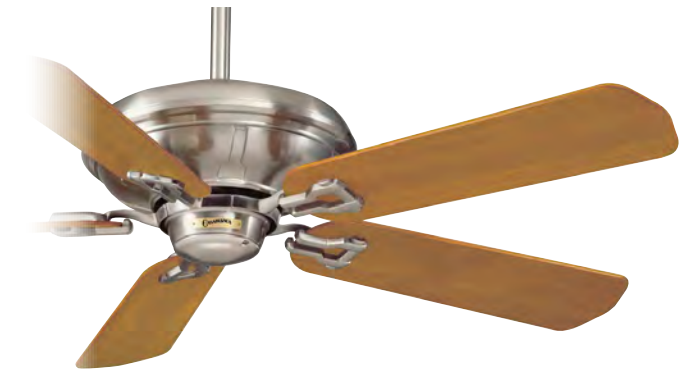

BRESCIA®

The Brescia fan brings warmth and beauty to any room setting. For an Arts and Crafts-inspired look, select richly toned wood blades and a mica light fixture.



BADGE
sold separately
see accessories page 119 for blade options

FEATURES

- XLP-2000™ motor / lifetime motor warranty
- 52" or 44" blade span / 15° blade pitch
- 4- or 5-blade configuration
- Multiple blade finish choices available (blades sold separately)
- Requires additional hanging support (included)

COMPATIBLE LIGHT FIXTURES

- Group A Light Fixtures (see pages 124-127)
- Group B Light Fixtures (see pages 127-129)

CONTROLS

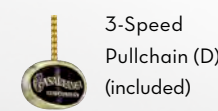

3-Speed
Pullchain (D)
(included)



Inteli-Touch3® (Z)
W-85 (included)
Six-speed wall control with full-range light dimming and reversing



Adapt-Touch™
W-52 (optional)
Three-speed remote control with full-range light dimming. Includes wall plate bracket.



Inteli-Touch3®
W-65 (optional)
Six-speed remote control with LCD display screen, full-range light dimming and reversing. Includes wall plate bracket.

DIMENSIONS

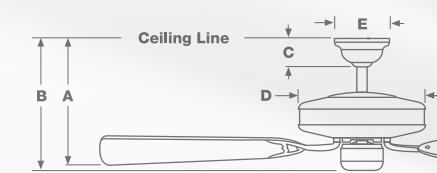

- A: 11.30"
- B: 12.60"
- C: 3.00"
- D: 14.00"
- E: 5.60"

ENERGY INFORMATION AT HIGH SPEED

Airflow: 6,591 cfm	Electricity Use: 116 w	Airflow Efficiency: 56.9 cfm/w
------------------------------	----------------------------------	--

9573D/Z
Oil-Rubbed Bronze motor shown with Teak blades and Shaker 4-light fixture



CEILING FANS

CANDELIER

ORNATE

TRADITIONAL

TRANSITIONAL

CONTEMPORARY

LOW PROFILE

DÉCOR SPECIFIC

OUTDOOR / INDOOR



CONTEMPORARY



3245Z
Brushed Nickel motor shown with
B32-DW Dark Walnut blades

STEALTH®

In the spirit of contemporary design, form follows function in fluid contours, swept wing blades and integrated halogen lighting. This original classic appeals to many tastes because of its timeless beauty and selection of finish options.



FEATURES

- XLP-2000™ motor / lifetime motor warranty
- 54" blade span / 14° blade pitch
- 5-blade configuration / exclusive blades sold separately
- Integrated 100-watt downlight with one T4 halogen bulb included
- No-light cap option sold separately (STLHC-xx); not available in -72 finish
- Low Ceiling Adapter (LCA) is not compatible
- Requires additional hanging support (included)

BLADE OPTIONS

B32-11	Snow White	B32-DC	Dark Cherry
B32-12	Glossy Black	B32-DW	Dark Walnut
B32-68	Graphite	B32-MG	Mahogany
B32-72	Architectural White	B32-MP	Maple
B32-79	Platinum	B32-TK	Teak

CONTROLS



Intelli-Touch3® (Z)
W-85 (included)
Six-speed wall control with
full-range light dimming
and reversing



Intelli-Touch3®
W-65 (optional)
Six-speed remote control with
LCD display screen, full-range
light dimming and reversing.
Includes wall plate bracket.

DIMENSIONS

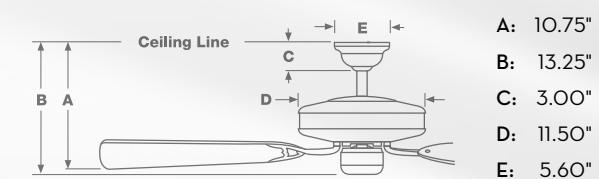

ENERGY INFORMATION AT HIGH SPEED

Airflow: 6,115 cfm	Electricity Use: 110 w	Airflow Efficiency: 55.6 cfm/w
------------------------------	----------------------------------	--

3232Z
Weathered Copper motor shown with
B32-DC Dark Cherry blades



3211Z
Snow White motor shown with
B32-11 Hi-Gloss Snow White blades



3268Z
Graphite motor shown with
B32-68 Graphite blades and
STLHC-68 no-light cap



3212Z
Glossy Black motor shown with
B32-12 Hi-Gloss Black blades



3272Z
Architectural White motor
shown with
B32-MP Maple blades



CONTEMPORARY



C45G695B
Alpha Bronze motor with
Dark Cherry blades



C43G45L
Brushed Nickel motor with reversible
Walnut / Burnt Walnut blades



C45G11B
Snow White motor with
Matte Snow White blades



C45G45B
Brushed Nickel motor with
Dark Walnut blades



Shown without
downrod cover



C43G546L
Brushed Cocoa motor
with reversible Walnut /
Burnt Walnut blades

STEALTH® DC NEW

Now more than ever, the Stealth DC lives up to its name, featuring our quietest motor yet. Casablanca's new DC technology is also extremely powerful and highly efficient—four to five times more than other motors. So while the fan may be quiet, the news won't be for long.



FEATURES

- DC-165 motor / lifetime motor warranty
- 54" blade span / 14° blade pitch
- Set of 5 exclusive blades included
- Integrated 100-watt downlight with one T4 halogen bulb included
- No-light cap option sold separately (STLHC-xx); not available in -695 finish
- Low Ceiling Adapter (LCA) is not compatible
- Requires additional hanging support (included)

CONTROL

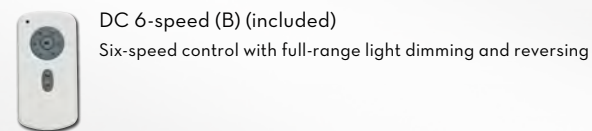

DIMENSIONS

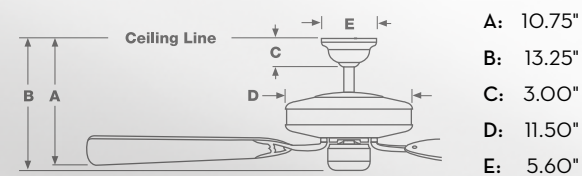

ENERGY INFORMATION AT HIGH SPEED

Airflow: 6,554 cfm	Electricity Use: 30 w	Airflow Efficiency: 218 cfm/w
------------------------------	---------------------------------	---

BULLET NEW

Inspired by the world-famous train, the Bullet is all about speed. This powerful performer moves a lot of air with maximum style. For unmatched performance in spacious loft environments, get on board.



FEATURES

- Direct Drive™ motor / lifetime motor warranty
- 54" blade span / 14° blade pitch
- Set of 5 exclusive reversible blades included
- Includes 2.5" and 12" downrods
- Integrated 100-watt downlight with one R7S halogen bulb included
- Minimum 9' ceiling required when using downrod cover
- Requires additional hanging support (included)
- Low Ceiling Adapter (LCA) is not compatible

CONTROLS



DIMENSIONS USING 12" DOWNROD

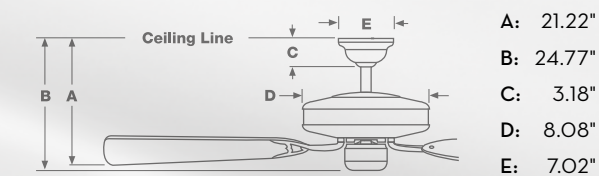

ENERGY INFORMATION AT HIGH SPEED

Airflow: 5,983 cfm	Electricity Use: 68 w	Airflow Efficiency: 87 cfm/w
------------------------------	---------------------------------	--

CONTEMPORARY

C39G199L
Chrome motor shown with
Matte Snow White blades



C22G11L
Snow White motor with
Glossy Snow White blades



C22G45L
Brushed Nickel motor with reversible
Espresso / Walnut blades



ANTION NEW

You may have to look twice to notice the Antion. But you'll be glad you did. With its frosted white glass bowl and artfully curved white blades, the Antion blends into any contemporary environment, beautifully.



FEATURES

- Direct Drive™ motor / lifetime motor warranty
- 52" blade span / 14° blade pitch
- Set of 5 exclusive ABS blades included
- Integrated 100-watt dimmable downlight with two 50w T4 halogen bulbs included

CONTROLS



Direct-Touch® (L)
W-74SL (included)
Four-speed wall control with
full-range light dimming,
reversing and CFL mode



Direct-Touch®
W-75SL (optional)
Four-speed remote control
with full-range light dimming,
reversing and CFL mode

DIMENSIONS

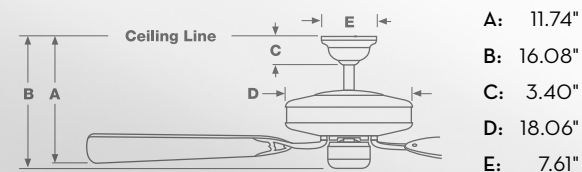

ENERGY INFORMATION AT HIGH SPEED

Airflow: 5,551 cfm	Electricity Use: 68 w	Airflow Efficiency: 81.4 cfm/w
------------------------------	---------------------------------	--

TERCERA™ NEW

Tercera may mean "third," but it should be first on your list for a small or medium-sized room. With its sleek triple-blade configuration and vintage curves, this contemporary classic combines the best of old and new.



FEATURES

- Direct Drive™ motor / lifetime motor warranty
- 52" blade span / 15° blade pitch
- Set of 3 exclusive blades included
- Integrated 100-watt dimmable downlight with two 50w T4 halogen bulbs included
- Requires additional hanging support (included)
- Low Ceiling Adapter (LCA) is not compatible

CONTROLS



Direct-Touch® (L)
W-74SL (included)
Four-speed wall control with
full-range light dimming,
reversing and CFL mode



Direct-Touch®
W-75SL (optional)
Four-speed remote control
with full-range light dimming,
reversing and CFL mode

DIMENSIONS

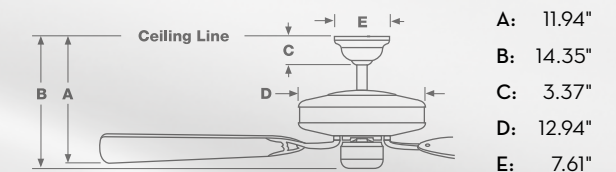

ENERGY INFORMATION AT HIGH SPEED

Airflow: 5,476 cfm	Electricity Use: 63.3 w	Airflow Efficiency: 86.5 cfm/w
------------------------------	-----------------------------------	--

CONTEMPORARY

93045M
Brushed Nickel motor with reversible
Platinum / Maple blades



TRIH-68
Graphite motor with reversible
Dark Cherry / Graphite blades



93011M
Snow White motor with
reversible Snow White /
Maple blades



93068M
Graphite motor with
reversible Dark Cherry /
Graphite blades



TRIH-11
Snow White motor with
reversible Maple /
Snow White blades



TRIH-45
Brushed Nickel motor
with reversible Platinum /
Maple blades, shown with
optional no-light cap



S3®

The S3 fan, inspired by a European sports coupe, features a sleek three-blade configuration. The choice of contemporary finishes include Brushed Nickel, Graphite, and Snow White. Exceptional value is further reinforced with integrated halogen lighting and the Versa-Touch2® control system.



FEATURES

- Direct Drive™ motor / lifetime motor warranty
- 54" blade span / 15° blade pitch
- Set of 3 exclusive reversible blades included
- Integrated 100-watt downlight with one T4 halogen bulb included
- No-light cap option available (S3C-xx)
- Low Ceiling Adapter (LCA) is not compatible
- Sloped Ceiling Adapter (SCA) is compatible with purchase of part 192220xx (see pages 134-135)

CONTROL

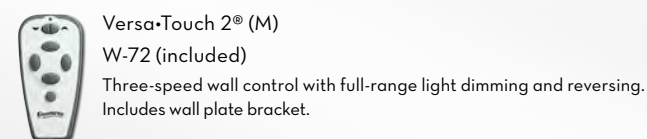

DIMENSIONS

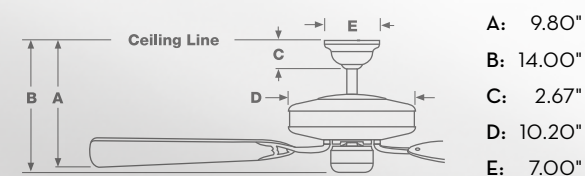

ENERGY INFORMATION AT HIGH SPEED

Airflow: 7,440 cfm	Electricity Use: 86 w	Airflow Efficiency: 89.8 cfm/w
------------------------------	---------------------------------	--

TRIDENT®

Casablanca's Trident ceiling fan epitomizes clean contemporary design and seamless performance. Its streamlined three-blade configuration, integrated halogen light and matching no-light cap have been engineered to echo the agile grace of an airplane propeller.



FEATURES

- Direct Drive™ motor / lifetime motor warranty
- 54" blade span / 14° blade pitch
- Set of 3 exclusive reversible blades included
- Integrated 100-watt downlight with one T4 halogen bulb included
- Optional no-light cap included
- Low Ceiling Adapter (LCA) is not compatible

CONTROL

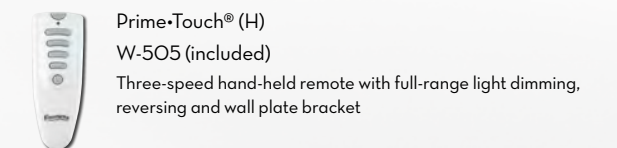

DIMENSIONS

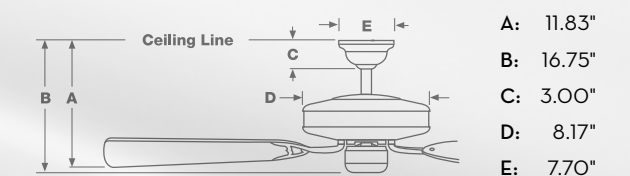

ENERGY INFORMATION AT HIGH SPEED

Airflow: 6,694 cfm	Electricity Use: 72 w	Airflow Efficiency: 92.7 cfm/w
------------------------------	---------------------------------	--

CONTEMPORARY



C17G546A
Brushed Cocoa motor with Mahogany blades

VITA™

With its angled planes and streamlined curves, the distinctive Vita is the first contemporary offering from Casablanca to include an uplight, which casts a soft, incandescent glow on the ceiling. Additional lighting is provided by a halogen-lit center bowl that indirectly illuminates a glass outer ring.



FEATURES

- XLP Plus® motor / lifetime motor warranty
- 52" blade span / 13° blade pitch
- Set of 5 exclusive blades included
- Integrated 90-watt uplight with six 15w bulbs included
- Integrated 100-watt downlight with two 50w T4 halogen bulbs included
- Uplight and downlight can be controlled independently
- Low Ceiling Adapter (LCA) is not compatible
- Requires additional hanging support (included)

CONTROL



Advan-Touch® (A)
W-63 (included)
Six-speed wall control with LCD display screen, full-range light dimming and reversing. Independent uplight and downlight operation. Includes wall plate bracket.

DIMENSIONS

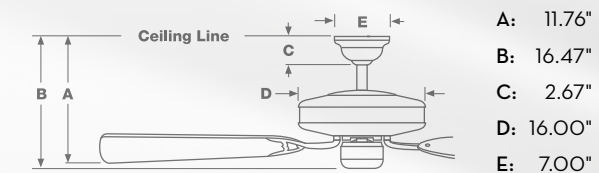

ENERGY INFORMATION AT HIGH SPEED

Airflow: 6,885 cfm	Electricity Use: 120 w	Airflow Efficiency: 57.6 cfm/w
------------------------------	----------------------------------	--

C17G199A
Chrome motor with Matte Snow White blades



C17G8A
Matte Black motor with Matte Black blades



C17G97A
Antique Pewter motor with Mahogany blades



C17G667A
Cherry Bronze motor with Mahogany blades



CONTEMPORARY



C28G12M
Glossy Black motor and blades

C28G11M
Snow White motor and blades



C29G11M
Snow White motor and blades

C29G12M
Glossy Black motor and blades



STAR™

Art and engineering converge in the graphic silhouette and aerodynamic performance of the Star ceiling fan. This sleek model features a streamlined three-blade configuration, integrated halogen downlight and sweeping 52-inch blade span, bringing comfort and style to contemporary interiors.



FEATURES

- Direct Drive™ motor / lifetime motor warranty
- 52" blade span / 15° blade pitch
- Set of 3 exclusive injection-molded ABS blades included
- Integrated 75-watt halogen downlight with bulb included

CONTROL



Versa-Touch 2® (M)
W-72 (included)
Three-speed wall control with full-range light dimming and reversing.
Includes wall plate bracket.

DIMENSIONS

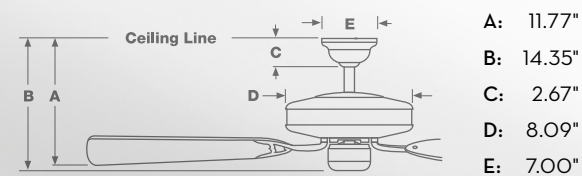

ENERGY INFORMATION AT HIGH SPEED

Airflow: 5,640 cfm	Electricity Use: 67 w	Airflow Efficiency: 84 cfm/w
------------------------------	---------------------------------	--

STARLET™

The Starlet adds an element of sculptural design and efficient performance to smaller-scale contemporary spaces. With its fluid contours, integrated halogen downlight, powerful motor and clean cutaway detailing, this fan is an ideal choice for hallways, dressing areas and other compact quarters.



FEATURES

- Direct Drive™ motor / lifetime motor warranty
- 36" blade span / 15° blade pitch
- Set of 3 exclusive injection-molded ABS blades included
- Integrated 75-watt halogen downlight with bulb included

CONTROL



Versa-Touch 2® (M)
W-72 (included)
Three-speed wall control with full-range light dimming and reversing.
Includes wall plate bracket.

DIMENSIONS

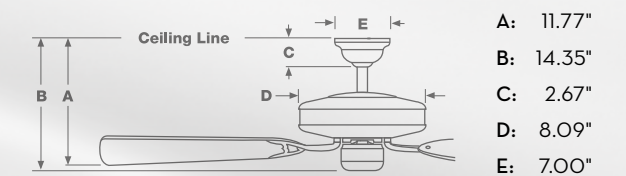

ENERGY INFORMATION AT HIGH SPEED

Airflow: 3,074 cfm	Electricity Use: 50 w	Airflow Efficiency: 62 cfm/w
------------------------------	---------------------------------	--

CONTEMPORARY



85U32M
Weathered Copper motor with Mahogany blades, shown with optional exclusive KGIM-32 halogen bullet light fixture

KGIM
Le Grande Exclusive
Halogen Bullet Fixture
100 watts
Available finishes:
Weathered Copper (-32)
Brushed Nickel (-45)

85U45M
Brushed Nickel motor with Mahogany blades



LE GRANDE™

Spacious environments with high ceilings present special needs for proper air circulation, regardless of the season. Casablanca answers these requirements with the Le Grande, a fan with exceptional air movement, unique contemporary styling and lasting beauty.



FEATURES

- Direct Drive™ motor / lifetime motor warranty
- 62" blade span / 14° blade pitch
- Set of 3 exclusive blades included
- Ultra high-performance design
- Low Ceiling Adapter (LCA) is not compatible

CONTROL



Versa-Touch 2® (M)
W-72 (included)
Three-speed wall control with full-range light dimming and reversing. Includes wall plate bracket.

DIMENSIONS

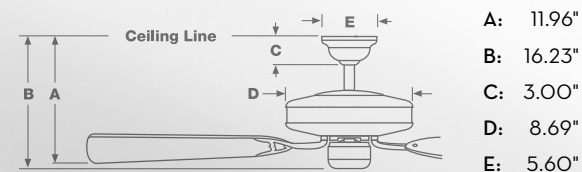

ENERGY INFORMATION AT HIGH SPEED

Airflow: 6,674 cfm	Electricity Use: 86 w	Airflow Efficiency: 78 cfm/w
------------------------------	---------------------------------	--



23B002
Snow White motor with MS2 White blades

MALIBU STAR®

The refreshing design of the Malibu Star will captivate your imagination. A bicycle sprocket serves as the hub, and the nautical look results from the airy silk fabric blades tensioned by fiberglass fishing rods. This large fan will become the focal point of any room.



FEATURES

- XLP-2000™ motor / lifetime motor warranty
- 84" blade span / 15° blade pitch
- Set of 5 exclusive silk blades included
- Chrome hardware accents
- Low Ceiling Adapter (LCA) is not compatible
- Minimum 9' ceiling required
- Uses 12" downrod (included)

COMPATIBLE LIGHT FIXTURES

Group A Light Fixtures (see pages 124-127)
Group B Light Fixtures (see pages 127-129)

CONTROLS



Adapt-Touch™
W-81 (included)
Four-speed wall control with full-range light dimming



Adapt-Touch™
W-52 (optional)
Three-speed remote control with full-range light dimming. Includes wall plate bracket.

DIMENSIONS

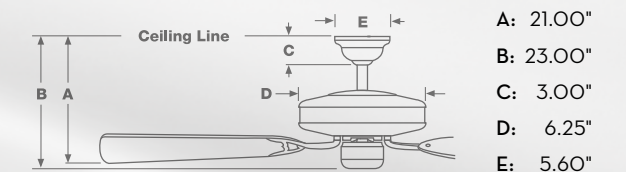

ENERGY INFORMATION AT HIGH SPEED

Airflow: 5,170 cfm	Electricity Use: 109 w	Airflow Efficiency: 47.4 cfm/w
------------------------------	----------------------------------	--

CONTEMPORARY

C10G199M
Chrome motor with Matte Black blades



C10G11M
Snow White motor with Snow White blades



C10G8M
Matte Black motor with Mahogany blades



MODENA® II

The streamlined curves, contemporary styling and quality craftsmanship that are hallmarks of classic Italian design have been incorporated into the Modena II. This graceful fan features an integrated halogen light and Dynamic Blade™ engineering with injection-molded ABS blades.



FEATURES

- Direct Drive™ motor / lifetime motor warranty
- 47" blade span / patented Dynamic Blade™ engineering
- Set of 5 exclusive injection-molded ABS blades included
- Integrated 100-watt downlight with one T4 halogen bulb included
- Sloped Ceiling Adapter (SCA) is not compatible without part 19222Oxx (see pages 134-135)
- Low Ceiling Adapter (LCA) is not compatible

CONTROL



Versa-Touch 2® (M)
W-72 (included)
Three-speed wall control with full-range light dimming and reversing. Includes wall plate bracket.

DIMENSIONS

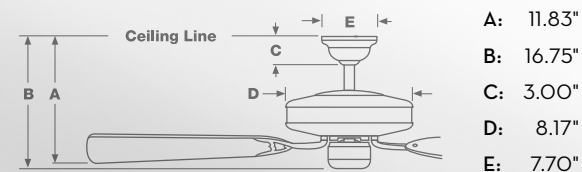

ENERGY INFORMATION AT HIGH SPEED

Airflow: 5,832 cfm	Electricity Use: 72 w	Airflow Efficiency: 81 cfm/w
------------------------------	---------------------------------	--



65G45D
Brushed Nickel motor with Mahogany blades

VERRAZANO®

Inspired by the drama of suspension bridges and sophisticated machinery, the Verrazano is truly unique among ceiling fans. The Brushed Nickel metal surfaces combined with Mahogany blades speak of contemporary elegance. Design elements include an exposed motor shaft, blades connected by cables and a stationary integrated halogen light.



FEATURES

- XLP-2000® motor / lifetime motor warranty
- 54" blade span / 13° blade pitch
- Set of 4 exclusive Mahogany blades included
- Integrated 100-watt downlight with one T4 halogen bulb included
- Low Ceiling Adapter (LCA) is not compatible
- Sloped Ceiling Adapter (SCA) is compatible with purchase of part 19222O45 (see pages 134-135)
- Minimum 10' ceiling required
- Requires additional hanging support (included)

CONTROLS



W-1811 (D) (included)
Four-speed wall control with full-range light dimming



Adapt-Touch™
W-52 (optional)
Three-speed remote control with full-range light dimming. Includes wall plate bracket.

DIMENSIONS

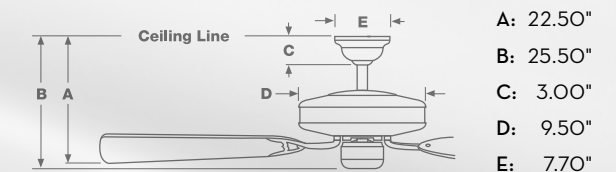

ENERGY INFORMATION AT HIGH SPEED

Airflow: 4,809 cfm	Electricity Use: 94.9 w	Airflow Efficiency: 50.7 cfm/w
------------------------------	-----------------------------------	--

CEILING FANS

CANDELIER

ORNATE

TRADITIONAL

TRANSITIONAL

CONTEMPORARY

LOW PROFILE

DÉCOR SPECIFIC

OUTDOOR / INDOOR



LOW PROFILE



C30G546H/L (52")
C35G546H/L (44")
Brushed Cocoa motor with
Walnut blades

C30G11H/L (52")
C35G11H/L (44")
Snow White motor with
Hi-Gloss Snow White blades



C30G707H/L (52")
C35G707H/L (44")
Iron Ore motor with
Carbon Fiber blades



C30G45H/L (52")
C35G45H/L (44")
Brushed Nickel motor with
Espresso blades



ISOTOPE®

Superior air circulation meets contemporary design in the Isotope ceiling fan. With its low profile and wing-swept blade configuration, this sleek fan is an ideal choice for flush-mount installation in interiors with lower ceilings. It is available in two blade spans for maximum versatility and style.



FEATURES

- Direct Drive™ motor / lifetime motor warranty
- 52" or 44" blade span / 14° blade pitch
- Set of 5 exclusive blades included
- Integrated 100-watt downlight with one T4 halogen bulb included
- Not suitable for installation on a sloped ceiling
- Low Ceiling Adapter (LCA) is not compatible

CONTROLS



Prime-Touch® (H)
W-505 (included)
Three-speed hand-held remote
with full-range light dimming,
reversing and wall plate bracket



Direct-Touch® (L)
W-74SL (included)
Four-speed wall control with
full-range light dimming,
reversing and CFL mode

Note: During 2011, there will be a transition from H models to L models.

DIMENSIONS

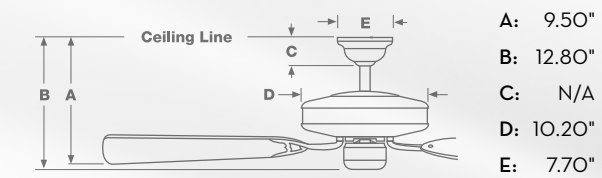

ENERGY INFORMATION AT HIGH SPEED

44" BLADE

Airflow: 3,915 cfm	Electricity Use: 73 w	Airflow Efficiency: 53.6 cfm/w
------------------------------	---------------------------------	--

52" BLADE

Airflow: 4,251 cfm	Electricity Use: 74 w	Airflow Efficiency: 57.5 cfm/w
------------------------------	---------------------------------	--

LOW PROFILE



C34G546M
Brushed Cocoa motor with
Reclaimed Antique blades



C2M72M
Architectural White motor with
Architectural White blades

VERMONT™

The compact silhouette and Colonial-inspired design details of the Vermont ceiling fan make it an ideal choice for traditional homes with lower ceilings. Five carved wood blades and a Scavo glass downlight add classical elegance while ensuring year-round comfort in living rooms, family rooms, kitchens, and other interior settings.



FEATURES

- Direct Drive™ motor / lifetime motor warranty
- 54" blade span / 15° blade pitch
- Set of 5 exclusive carved featherwood blades included
- Integrated 100-watt downlight with one R7S halogen bulb included
- Not suitable for installation on a sloped ceiling
- Low Ceiling Adapter (LCA) is not compatible

CONTROL



Versa-Touch 2® (M)
W-72 (included)
Three-speed wall control with full-range light dimming and reversing.
Includes wall plate bracket.

DIMENSIONS

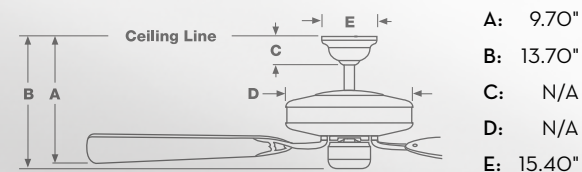

ENERGY INFORMATION AT HIGH SPEED

Airflow: 4,406 cfm	Electricity Use: 83 w	Airflow Efficiency: 53 cfm/w
------------------------------	---------------------------------	--

SILHOUETTE™ II

The understated Silhouette II fan combines whisper-quiet performance with a low-profile design that enables it to blend seamlessly into a ceiling. Mounted with an integrated medallion, the fan is an ideal solution for rooms with low ceilings.



FEATURES

- Direct Drive™ motor / lifetime motor warranty
- 52" blade span / 15° blade pitch
- Set of 5 exclusive blades included
- Integrated 100-watt downlight with one R7S halogen bulb included
- Not suitable for installation on a sloped ceiling
- Low Ceiling Adapter (LCA) is not compatible

CONTROL



Versa-Touch 2® (M)
W-72 (included)
Three-speed wall control with full-range light dimming and reversing.
Includes wall plate bracket.

DIMENSIONS

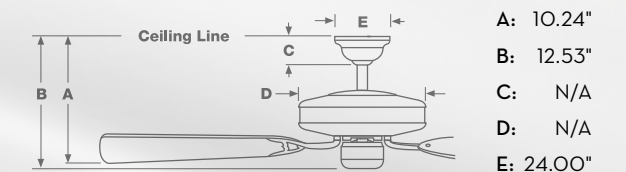

ENERGY INFORMATION AT HIGH SPEED

Airflow: 4,739 cfm	Electricity Use: 68.7 w	Airflow Efficiency: 69 cfm/w
------------------------------	-----------------------------------	--

LOW PROFILE



82U45D
Brushed Nickel motor with reversible
Mahogany / Dark Walnut blades

72U11D (42") / 82U11D (52")
Snow White motor with reversible
Snow White / Bleached Oak blades



82U4D
Antique Brass motor with reversible
Antique Oak / Bleached Oak blades



FOUR SEASONS® III HUGGER

With its low-profile, versatile design, the Four Seasons III Hugger is an ideal solution for homes or offices with ceilings less than eight feet high. Add a light fixture for even more functionality.



FEATURES

- Direct Drive™ motor / lifetime motor warranty
- 52" or 42" blade span / 12° blade pitch
- Set of 5 reversible blades included
- Low Ceiling Adapter (LCA) is not compatible
- Remote control adaptable (order control WRF3-xx)

COMPATIBLE LIGHT FIXTURES

Group B Light Fixtures (see pages 127-129)

CONTROLS



3-Speed
Pullchain (D)
(included)



WRF3-XX
(optional)
Three-speed remote control
with full-range light dimming
and reversing



Adapt-Touch™
W-52 (optional)
Three-speed remote control
with full-range light dimming.
Includes wall plate bracket.

Note: Must use accessory control to operate light fixtures without a pullchain.

82U72D
Architectural White motor with
reversible Architectural White /
Bleached Oak blades



DIMENSIONS

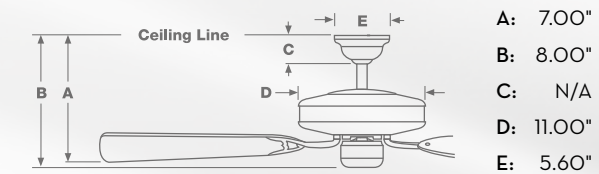

ENERGY INFORMATION AT HIGH SPEED

52" BLADE SPAN

Airflow:	Electricity Use:	Airflow Efficiency:
2,126 cfm	67 w	31.8 cfm/w

42" BLADE SPAN

Airflow:	Electricity Use:	Airflow Efficiency:
2,400 cfm	62 w	38.7 cfm/w

CEILING FANS

CANDELIER

ORNATE

TRADITIONAL

TRANSITIONAL

CONTEMPORARY

LOW PROFILE

DÉCOR SPECIFIC

OUTDOOR / INDOOR



DÉCOR SPECIFIC



97032Z
Weathered Copper motor with Amber shade and Teak blades

97052Z
Bronze Patina motor with Amber shade and Teak blades

MISSION®

Simplicity. Craftsmanship. Elegance. The Mission fan captures the original inspiration of the Arts and Crafts movement. Share in this historic period of home decoration with a Casablanca masterpiece that reveals geometric design elements, genuine art glass and natural metal finishes.



FEATURES

- XLP-2100™ motor / lifetime motor warranty
- 56" blade span / 13° blade pitch
- Set of 5 exclusive blades included
- Integrated 120-watt incandescent downlight with two 60w bulbs included
- Low Ceiling Adapter (LCA) is not compatible
- Sloped Ceiling Adapter (SCA) is not compatible without part 192220xx (see pages 134-135)
- Requires additional hanging support (included)

CONTROLS



Intel-Touch3® (Z)
W-85 (included)
Six-speed wall control with full-range light dimming and reversing



Intel-Touch3®
W-65 (optional)
Six-speed remote control with LCD display screen, full-range light dimming and reversing. Includes wall plate bracket.

DIMENSIONS

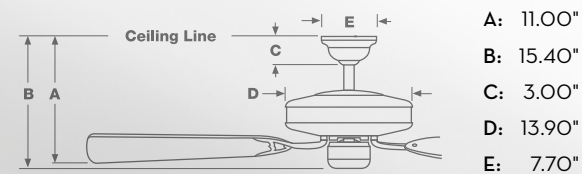

ENERGY INFORMATION AT HIGH SPEED

Airflow: 6,162 cfm	Electricity Use: 102 w	Airflow Efficiency: 60.5 cfm/w
------------------------------	----------------------------------	--



P4M55H
Amber Bronze motor with reversible Mahogany / Medium Oak blades and Amber shade

BUNGALOW™

Like the Craftsman-style structures that inspired it, the Bungalow ceiling fan brings simplicity, beauty and efficiency to today's homes. Its geometric detailing, illuminated motor housing with art glass shades, and reversible custom blades combine style and practicality.



FEATURES

- Direct Drive™ motor / lifetime motor warranty
- 56" blade span / 13° blade pitch
- Set of 4 exclusive blades included
- Integrated 120-watt downlight with two 60w candelabra bulbs included
- Low Ceiling Adapter (LCA) is not compatible
- Sloped Ceiling Adapter (SCA) is not compatible without part 19222055 (see pages 134-135)
- Requires additional hanging support (included)

CONTROL



Prime-Touch® (H)
W-505 (included)
Three-speed hand-held remote with full-range light dimming, reversing and wall plate bracket

DIMENSIONS

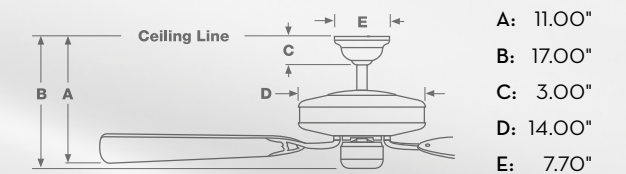

ENERGY INFORMATION AT HIGH SPEED

Airflow: 6,193 cfm	Electricity Use: 73 w	Airflow Efficiency: 84.6 cfm/w
------------------------------	---------------------------------	--

DÉCOR SPECIFIC

89U546M
Brushed Cocoa motor with reversible
Dark Walnut / Walnut blades, shown with
optional exclusive KG89-546 halogen light fixture

KG89
Marrakesh Exclusive
Halogen Fixture with Scavo Shade
100 watts
Available finishes:
Oil-Rubbed Bronze / Amber glass (-73)
Antique Pewter (-97)
Brushed Cocoa (-546)

89U73M
Oil-Rubbed Bronze motor with
Teak blades

89U97M
Antique Pewter motor with
Mahogany blades

MARRAKESH®

For centuries, people have been fascinated by the sumptuous textures and graceful architecture of Moroccan design. With its exotic embellishments, the Marrakesh ceiling fan is an authentic reflection of this rich cultural tradition. Use the included ornamental finial, or add the optional hand-blown glass light fixture.

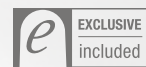

FEATURES

- Direct Drive™ motor / lifetime motor warranty
- 64" blade span / 14° blade pitch
- Set of 3 exclusive blades included
- Matching finial included for no-light option
- Minimum 9' ceiling required
- Low Ceiling Adapter (LCA) is not compatible
- Requires additional hanging support (included)
- Uses 6" downrod (included)

CONTROL



Versa-Touch 2® (M)
W-72 (included)
Three-speed wall control with full-range light dimming and reversing.
Includes wall plate bracket.

DIMENSIONS

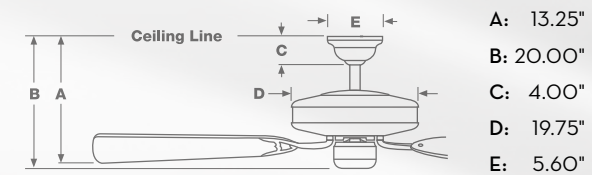

ENERGY INFORMATION AT HIGH SPEED

Airflow: 7,852 cfm	Electricity Use: 92 w	Airflow Efficiency: 85 cfm/w
------------------------------	---------------------------------	--

DÉCOR SPECIFIC

C12S72M

Architectural White motor shown with BBB21-72D Distressed Architectural White beadboard blades



Shown with BIO5 Architectural White blades, K44TA-72 four-light fitter and CSG16 side glass



COTTAGE™

Indulge in cozy style with the Cottage ceiling fan, adorned with beadboard detailing and concealed hardware inspired by vintage paneling. For added charm, choose matching beadboard blades or an optional downlight.



FEATURES

- Direct Drive™ motor / lifetime motor warranty
- 52" or 44" blade span / 15° blade pitch
- 5-blade configuration
- Multiple blade finish choices available (blades sold separately)
- ETL Wet-rated model available (see page 102)

COMPATIBLE LIGHT FIXTURES

Group A Light Fixtures (see pages 124-127)

Group B Light Fixtures (see pages 127-129)

CONTROL



Versa-Touch 2® (M) W-72 (included)
Three-speed wall control with full-range light dimming and reversing. Includes wall plate bracket.

DIMENSIONS

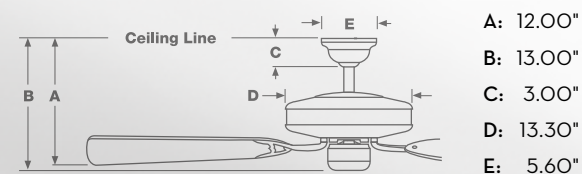

ENERGY INFORMATION AT HIGH SPEED

Airflow: 6,482 cfm	Electricity Use: 84 w	Airflow Efficiency: 77 cfm/w
------------------------------	---------------------------------	--

C23U73K

Oil-Rubbed Bronze motor with Natural Split Bamboo ABS blades, shown with optional exclusive KG87 light fixture



KG87

Key Largo II Exclusive Three-Light Integrated Fixture with Bamboo-Look Accents
180 watts (three 60w candelabra bulbs)
Available finishes:
Oil-Rubbed Bronze (-73)

Shown without light fixture



KEY LARGO® II

Casablanca brings the laid-back pace of the Florida Keys indoors with the Key Largo II fan. Featuring cane-style stitched bamboo detailing on the motor housing and blade holders, and ABS blades that replicate split bamboo, the Key Largo II is a charming example of British West Indies style.



FEATURES

- Direct Drive™ motor / lifetime motor warranty
- 52" blade span / 15° blade pitch
- Set of 5 exclusive ABS blades included
- Requires additional hanging support (included)

CONTROLS



4-Speed Pullchain (K) (included)



Adapt-Touch™ W-52 (optional)
Three-speed remote control with full-range light dimming. Includes wall plate bracket.

DIMENSIONS

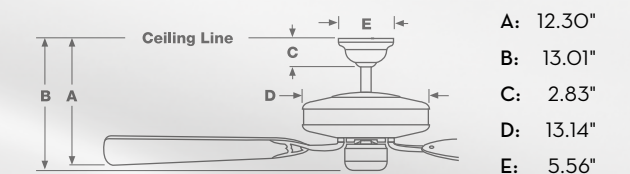

ENERGY INFORMATION AT HIGH SPEED

Airflow: 5,510 cfm	Electricity Use: 80 w	Airflow Efficiency: 69 cfm/w
------------------------------	---------------------------------	--

DÉCOR SPECIFIC



P2G61H
French Crème motor with reversible
Classic White / Maple blades and light
fixture with glass bowl

P2G546H
Brushed Cocoa motor
with reversible Walnut /
Dark Walnut blades,
shown with no-light finial



P2G63H
Tuscan Sunset motor
with reversible
Burnt Relic /
Burnt Cherry blades



LA FLEUR®

The design of the La Fleur ceiling fan was inspired by the belief that comfortable, lived-in environments can be elegant, too. Delicate embellishments on the blade irons and optional light fixture and vintage-inspired styling add a deliciously feminine touch.



FEATURES

- Direct Drive™ motor / lifetime motor warranty
- 56" blade span / 15° blade pitch
- Set of 5 exclusive reversible blades included
- Integrated 120-watt downlight with two 60w bulbs included
- Optional no-light finial included

CONTROL

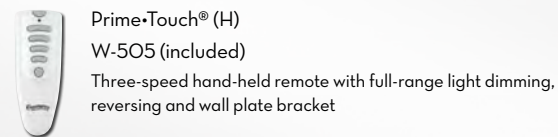

DIMENSIONS

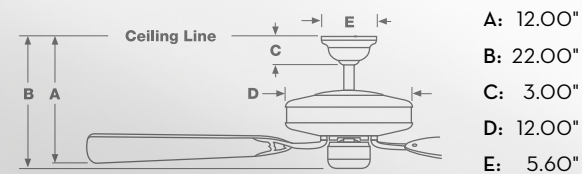

ENERGY INFORMATION AT HIGH SPEED

Airflow: 5,909 cfm	Electricity Use: 69 w	Airflow Efficiency: 86 cfm/w
------------------------------	---------------------------------	--



86U89M
Textured Matte Black motor with
mica accent light and Relic blades,
shown with optional exclusive KG86-89
three-light fixture with mica shades

KG86
Wilderness Exclusive
Three-Light Incandescent
Fixture with Mica Shades
180 watts (three 60w candelabra bulbs)
Available finishes:
Textured Matte Black (-89)

Shown without
optional light fixture



WILDERNESS®

In years past, people visited majestic lodges across America to experience the rugged beauty of the great outdoors. Casablanca's Wilderness Collection is a graceful nod to this grand tradition. The spectacular, removable silhouette display of bears, moose and Douglas firs set against a back-lit mica light fixture provides a warm glow to any room.



FEATURES

- Direct Drive™ motor / lifetime motor warranty
- 54" blade span / 14° blade pitch
- Set of 5 exclusive reversible blades included
- 45-watt back-lit LED-illuminated body with 44,000-hour bulb life
- Illuminated body and optional downlight can be controlled independently
- Silhouette is removable for added versatility
- Low Ceiling Adapter (LCA) is not compatible
- Minimum 9' ceiling required
- Requires additional hanging support (included)

CONTROL

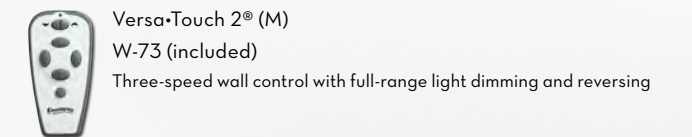

DIMENSIONS

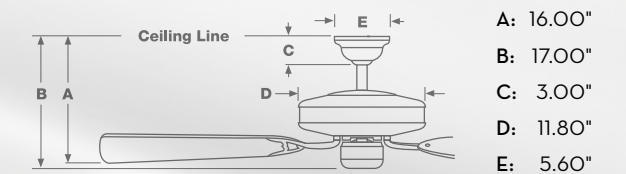

ENERGY INFORMATION AT HIGH SPEED

Airflow: 6,772 cfm	Electricity Use: 90 w	Airflow Efficiency: 75 cfm/w
------------------------------	---------------------------------	--

CEILING FANS

CANDELIER

ORNATE

TRADITIONAL

TRANSITIONAL

CONTEMPORARY

LOW PROFILE

DÉCOR SPECIFIC

OUTDOOR / INDOOR



Heritage™ ceiling fan

OUTDOOR / INDOOR

C19500K

Aged Bronze motor shown with BL-ADK-RA Adirondack outdoor carved featherwood blades in Reclaimed Antique and optional exclusive KGC10A-500 light fixture

KGC10A

Heritage Exclusive
Outdoor Beveled-Glass
Halogen Lantern
100 watts
ETL Rated for wet locations
Available finishes:
Aged Bronze (-500)
Brushed Cocoa (-546)
Bullion Black (-624)

BLADE OPTIONS

C19546K

Brushed Cocoa motor shown with BL-TPW-WB Tropical Wicker outdoor blades in Weathered Bronze



C19624F

Bullion Black motor shown with BL-ADK-RA Adirondack outdoor blades in Reclaimed Antique



HERITAGE™

During the Industrial Revolution, innovations in manufacturing enabled artisans to create furniture from cast iron. The Heritage fan incorporates many of the design details featured in antique castings, including vertical ribbing on its motor housing, raised type on the switch cap and a custom cobblestone texture on the fan body, cap and inset portions of the blade medallions.

The ETL Wet-rated Heritage is available in three finishes. The optional exclusive Wet-rated light kits include a beveled-glass lantern suitable for illuminating large spaces, a globe lantern with frosted opal glass, and a four-light fixture.



FEATURES

- XTR200™ 30mm motor / lifetime motor warranty
- 60" blade span / 14° blade pitch
- Modular configuration for maximum versatility
- Set of 5 exclusive outdoor blades sold separately
- Moisture-resistant motor and enclosed housing
- Stainless steel hardware
- ETL rated for wet locations (use only wet-rated light fixtures for use in wet locations)
- Minimum 9' ceiling required
- Low Ceiling Adapter (LCA) is not compatible
- Requires additional hanging support (included)

BLADE OPTIONS (SOLD SEPARATELY)

- BL-ADK-RA Adirondack in Reclaimed Antique
- BL-TPW-WB Tropical Wicker in Weathered Bronze

COMPATIBLE LIGHT FIXTURES

- Group A Light Fixtures (see pages 124-127)
- Heritage Exclusive Light Fixture KGC10A

CONTROLS



4-Speed Pullchain (K)
(included with C19546K and C19500K)



W-81 (included with C19624F)
Four-speed wall control with full-range light dimming.
No reversing function.



Adapt-Touch™
W-52 (optional—indoor only)
Three-speed remote control with full-range light dimming.
Includes wall plate bracket.

DIMENSIONS

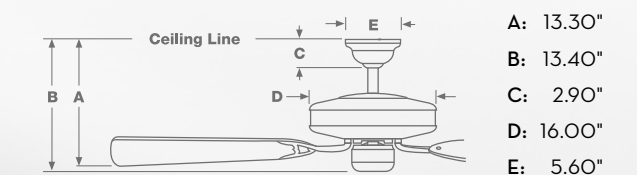

ENERGY INFORMATION AT HIGH SPEED

ADIRONDACK BLADES

Airflow: 7,932 cfm	Electricity Use: 96.4 w	Airflow Efficiency: 82.3 cfm/w
------------------------------	-----------------------------------	--

TROPICAL WICKER BLADES

Airflow: 6,736 cfm	Electricity Use: 99.3 w	Airflow Efficiency: 67.8 cfm/w
------------------------------	-----------------------------------	--

OUTDOOR / INDOOR

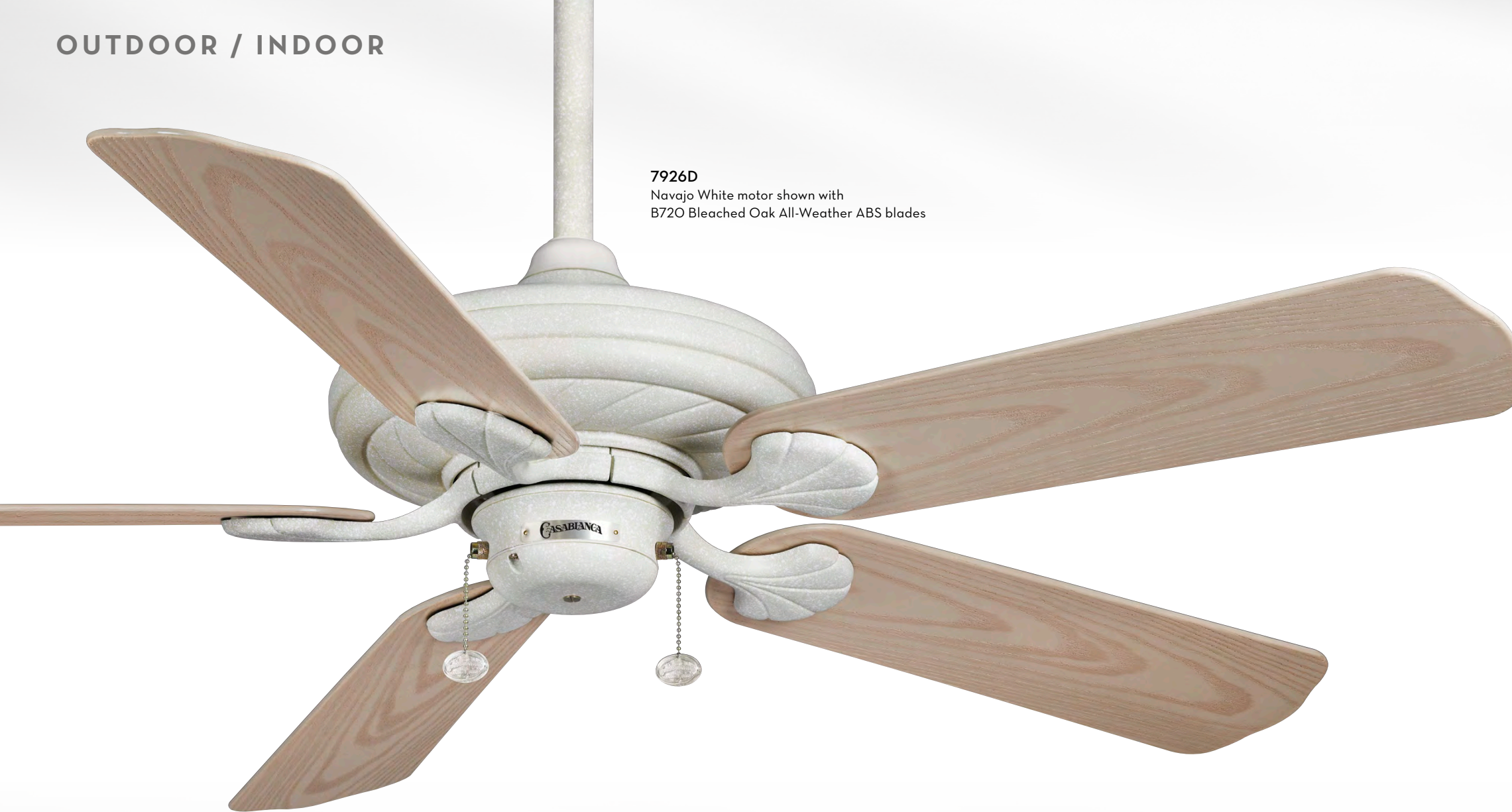

7926D
Navajo White motor shown with
B720 Bleached Oak All-Weather ABS blades

7988D
Matte Black motor shown with
B726 Dark Walnut blades and
KGC12A-624 outdoor four-light fixture



79669D
Restoration Bronze motor shown
with B718 Matte Black
All-Weather ABS blades



7946D
Rustic Iron motor shown
with Matte Black blades



LANAI®

Casablanca takes originality and elegance outdoors with the ETL Wet-rated Lanai. With blade holders highlighted by a tropical-inspired shell design, the Lanai adds warmth and casual comfort to decks, patios, sunrooms and verandas.



see accessories
page 120 for
blade options

FEATURES

- Direct Drive™ motor / lifetime motor warranty
- 53" or 45" blade span / 16° blade pitch
- Multiple All-Weather blade finish choices available (blades sold separately)
- ETL rated for wet locations / Use only Wet-rated light fixtures in wet locations
- Stainless steel hardware / moisture-resistant motor
- Low Ceiling Adapter (LCA) is not compatible when used in wet locations

COMPATIBLE LIGHT FIXTURES

Group A Light Fixtures (see pages 124-127)

Group B Light Fixtures (see pages 127-129)

CONTROLS

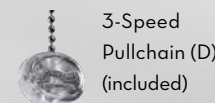

3-Speed
Pullchain (D)
(included)



Adapt-Touch™
W-52 (optional—indoor only)
Three-speed remote control with
full-range light dimming. Includes
wall plate bracket.

DIMENSIONS

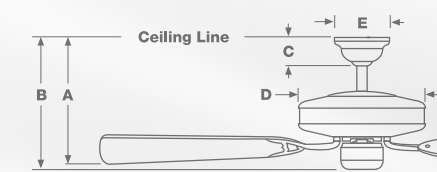

- A: 11.10"
- B: 12.75"
- C: 3.00"
- D: 12.60"
- E: 5.60"

ENERGY INFORMATION AT HIGH SPEED

53" BLADE

Airflow: 6,790 cfm	Electricity Use: 90 w	Airflow Efficiency: 75 cfm/w
------------------------------	---------------------------------	--

45" BLADE

Airflow: 5,663 cfm	Electricity Use: 85 w	Airflow Efficiency: 67 cfm/w
------------------------------	---------------------------------	--

7911D
Snow White motor shown
with Matte Snow White blades



7949D
Washed Bronze motor shown
with Weathered Pine blades



OUTDOOR / INDOOR



C12D9DD
Distressed Classic White motor with Distressed Classic White beadboard-style All-Weather blades, shown with KG2WA-9 light fixture



66D11G
Snow White motor shown with B527-11 Matte Snow White All-Weather ABS blades



C12D89D
Textured Matte Black motor with Cocoa beadboard-style All-Weather blades



66D73G
Oil-Rubbed Bronze motor shown with B527-DW Dark Walnut All-Weather ABS blades, K1KA-73 Damp-rated light fitter, and G5O2 glass

COTTAGE WET™

With its vintage-inspired beadboard detailing, the ETL Wet-rated Cottage Wet ceiling fan brings the tranquil charm of a seaside or country cottage outside. Matching beadboard-style ABS blades add timeless beauty and comfort.



FEATURES

- Direct Drive™ motor / lifetime motor warranty
- 52" blade span / 15° blade pitch
- Set of 5 exclusive All-Weather ABS blades included
- ETL rated for wet locations / Use only Wet-rated light fixtures in wet locations
- Stainless steel hardware
- Moisture-resistant motor and enclosed housing

COMPATIBLE LIGHT FIXTURES

Group A Light Fixtures (see pages 124-127)

Group B Light Fixtures (see pages 127-129)

CONTROLS

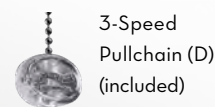

3-Speed Pullchain (D) (included)



Adapt-Touch™ W-52 (optional—indoor only) Three-speed remote control with full-range light dimming. Includes wall plate bracket.

DIMENSIONS

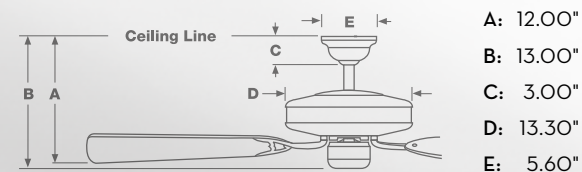

ENERGY INFORMATION AT HIGH SPEED

Airflow: 6,361 cfm	Electricity Use: 82 w	Airflow Efficiency: 77.3 cfm/w
------------------------------	---------------------------------	--

PANAMA® DAMP

The classic styling of the Panama Damp ceiling fan brings a breath of fresh air to humid locations inside and out. This ETL Damp-rated version of the traditional Panama fan enhances circulation in any potentially damp indoor environment, including kitchens, bathrooms, sunrooms, laundry rooms – even enclosed porches and verandas.



FEATURES

- XLP-2000™ motor / lifetime motor warranty
- 50" blade span / 15° blade pitch
- 4- or 5-blade configuration
- Multiple All-Weather blade finish choices available (blades sold separately)
- ETL rated for damp or humid locations
- Stainless steel hardware / moisture-resistant motor
- Low Ceiling Adapter (LCA) is not compatible when used in damp or humid locations

COMPATIBLE LIGHT FIXTURES

Group A Light Fixtures (see pages 124-127)

Group B Light Fixtures (see pages 127-129)

CONTROLS

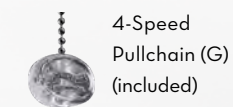

4-Speed Pullchain (G) (included)



Adapt-Touch™ W-52 (optional—indoor only) Three-speed remote control with full-range light dimming. Includes wall plate bracket.

DIMENSIONS

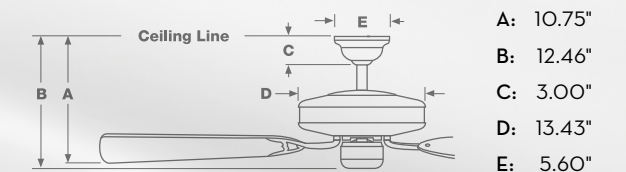

ENERGY INFORMATION AT HIGH SPEED

Airflow: 6,226 cfm	Electricity Use: 108 w	Airflow Efficiency: 57.6 cfm/w
------------------------------	----------------------------------	--

OUTDOOR / INDOOR



C18G500F
Aged Bronze motor shown with
Reclaimed Antique blades



83U46D
Rustic Iron motor with Rustic Iron
All-Weather ABS blades



83U11D
Snow White motor with
White All-Weather ABS blades

ATRIA™

Make a statement of graceful refinement on a grand scale with the Damp-rated Atria ceiling fan. The faux alabaster motor housing includes both an uplight and downlight that illuminate the entire fan body with a warm, ambient glow.



FEATURES

- XTR200™ 30mm motor / lifetime motor warranty
- ETL rated for damp or humid locations
- 68" blade span / 11° blade pitch
- Set of 5 exclusive outdoor carved featherwood blades included
- Integrated 120-watt uplight with eight 15w bulbs included
- Integrated 100-watt downlight with two 50w T4 halogen bulbs included
- Moisture-resistant motor / stainless steel hardware
- Minimum 9' ceiling required
- Low Ceiling Adapter (LCA) is not compatible
- Requires additional hanging support (included)

CONTROL

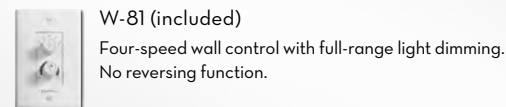

DIMENSIONS

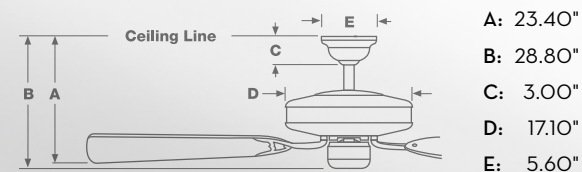

ENERGY INFORMATION AT HIGH SPEED

Airflow: 9,042 cfm	Electricity Use: 93 w	Airflow Efficiency: 97.4 cfm/w
------------------------------	---------------------------------	--

FOUR SEASONS® III OUTSIDER

The Four Seasons III Outsider ceiling fan brings lasting comfort and value to indoor and outdoor home environments all year round. This versatile fan combines traditional styling with an ETL Damp rating.



FEATURES

- Direct Drive™ motor / lifetime motor warranty
- 52" blade span / 13° blade pitch
- Set of 5 All-Weather ABS blades included
- ETL rated for damp or humid locations
- Use only Damp- or Wet-rated light fixtures in damp locations
- Moisture-resistant motor / stainless steel hardware
- Low Ceiling Adapter (LCA) is not compatible

COMPATIBLE LIGHT FIXTURES

Group B Light Fixtures (see pages 127-129)

Note: Must use accessory control to operate light fixtures without a pullchain.

CONTROLS



DIMENSIONS

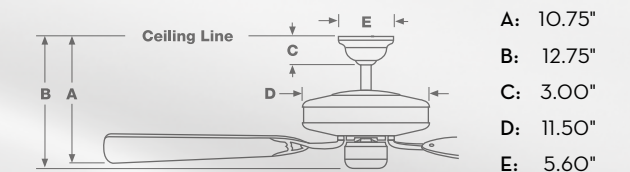

ENERGY INFORMATION AT HIGH SPEED

Airflow: 5,439 cfm	Electricity Use: 60 w	Airflow Efficiency: 90.7 cfm/w
------------------------------	---------------------------------	--

41U11D
Snow White motor with
Snow White All-Weather ABS blades



41U546D
Brushed Cocoa motor with
Brushed Cocoa All-Weather
ABS blades



41U45D
Brushed Nickel motor with
Matte Black All-Weather
ABS blades



41U46D
Rustic Iron motor with
Rustic Iron All-Weather
ABS blades



WAILEA®

The ETL Damp-rated Wailea fan, inspired by Casablanca's popular Capistrano and Lanai fans, is perfectly suited for small spaces. This 31-inch-wide fan is ideal for bathrooms, laundry rooms, walk-in closets and kitchens where ventilation is needed.



FEATURES

- Direct Drive™ motor / lifetime motor warranty
- 31" blade span / 25° blade pitch (optimized for maximum air movement)
- Set of 6 custom All-Weather ABS blades included
- ETL rated for damp or humid locations
- Moisture-resistant motor / stainless steel hardware
- Use only Damp- or Wet-rated light fixtures in damp locations
- Low Ceiling Adapter (LCA) is not compatible when used in damp or humid locations

COMPATIBLE LIGHT FIXTURES

- Group A Light Fixtures (see pages 124-127)
- Group B Light Fixtures (see pages 127-129)

CONTROLS

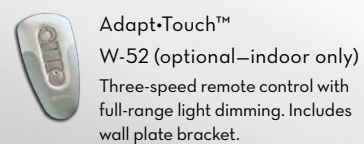
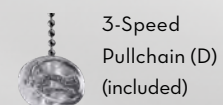

DIMENSIONS

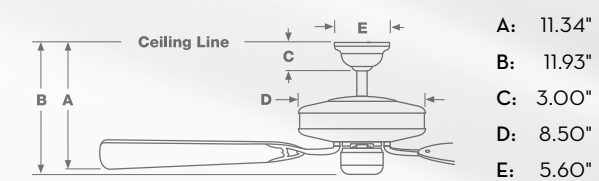

ENERGY INFORMATION AT HIGH SPEED

Airflow: 3,127 cfm	Electricity Use: 51 w	Airflow Efficiency: 61.9 cfm/w
------------------------------	---------------------------------	--

OUTDOOR / INDOOR



4726D
Navajo White motor shown with
B719 Classic White All-Weather ABS blades

4746D
Rustic Iron motor shown with
B722 Rustic Iron All-Weather ABS blades



C25G624F
Bullion Black motor with
Reclaimed Antique blades

ESTRADA®

Casablanca creates fans for every environment and mood. The Estrada is casual and colorful, with wrought iron trim inserts that harmonize with outdoor furniture décor. ETL Damp-rated, the Estrada is specially adapted for humid locations.



FEATURES

- Direct Drive™ motor / lifetime motor warranty
- 52" or 44" blade span / 15° blade pitch
- 5-blade configuration
- Multiple All-Weather blade finish choices available (blades sold separately)
- ETL rated for damp or humid locations
- Use only Damp- or Wet-rated light fixtures in damp locations
- Stainless steel hardware / moisture-resistant motor
- Low Ceiling Adapter (LCA) is not compatible when used in damp or humid locations

COMPATIBLE LIGHT FIXTURES

Group A Light Fixtures (see pages 124-127)
Group B Light Fixtures (see pages 127-129)

CONTROLS

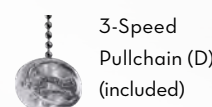

3-Speed
Pullchain (D)
(included)



Adapt-Touch™
W-52 (optional—indoor only)
Three-speed remote control with
full-range light dimming. Includes
wall plate bracket.

DIMENSIONS

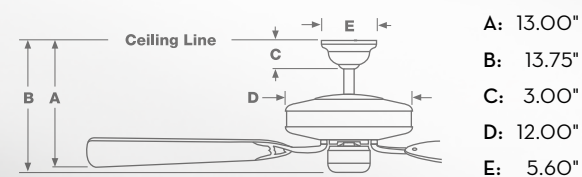

ENERGY INFORMATION AT HIGH SPEED

52" BLADE

Airflow: 6,734 cfm	Electricity Use: 89 w	Airflow Efficiency: 75.3 cfm/w
------------------------------	---------------------------------	--

44" BLADE

Airflow: 5,238 cfm	Electricity Use: 82 w	Airflow Efficiency: 63.7 cfm/w
------------------------------	---------------------------------	--

TWAIN™

This exquisite fan has been forged to replicate the look of ornamental castings from furniture displayed in 19th-century English parks. The lattice-weave pattern on the fan body, cast type on the upper motor housing, botanically inspired blade irons, and integrated lighting with faux alabaster glass make the Twain one of a kind.



FEATURES

- XTR200™ 30mm motor / lifetime motor warranty
- ETL rated for damp or humid locations
- 60" blade span / 14° blade pitch
- Set of 5 exclusive outdoor carved featherwood blades included
- Moisture-resistant motor / stainless steel hardware
- Integrated 150-watt uplight with six 25w bulbs included
- Integrated 100-watt downlight with two 50w T4 halogen bulbs included
- Low ceiling adapter (LCA) is not compatible
- Requires additional hanging support (included)

CONTROL



W-81 (F) (included)
Four-speed wall control with full-range light dimming.
No reversing function.

DIMENSIONS

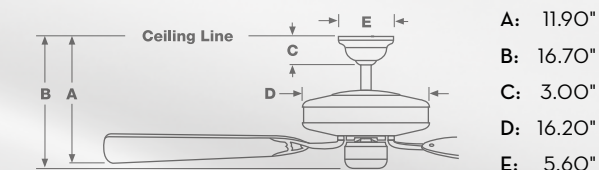

ENERGY INFORMATION AT HIGH SPEED

Airflow: 8,173 cfm	Electricity Use: 97 w	Airflow Efficiency: 84.3 cfm/w
------------------------------	---------------------------------	--

OUTDOOR / INDOOR

77546D
Brushed Cocoa motor shown
with B420 Walnut blades



C20G624F
Bullion Black motor with
Reclaimed Antique blades



7711D

Snow White motor shown
with B817 Matte Snow
White All-Weather
ABS blades



7745D

Brushed Nickel motor
shown with
B818 Matte Black
All-Weather ABS blades



UTOPIAN®

The versatile Utopian fan is ideally suited for humid environments. Smooth contours and simple lines provide a clean, progressive look that enhances décor without distraction. For bathrooms, kitchens and verandas, the Utopian is the perfect choice.



see accessories
page 120 for
blade options

FEATURES

- Direct Drive™ motor / lifetime motor warranty
- 50" or 42" blade span / 16° blade pitch
- Multiple All-Weather blade finish choices available (blades sold separately)
- ETL rated for damp or humid locations
- Use only Damp- or Wet-rated light fixtures in outdoor or damp locations
- Stainless steel hardware / moisture-resistant motor
- Low Ceiling Adapter (LCA) is not compatible when used in damp or humid locations

COMPATIBLE LIGHT FIXTURES

Group A Light Fixtures (see pages 124-127)

Group B Light Fixtures (see pages 127-129)

CONTROLS



3-Speed
Pullchain (D)
(included)



Adapt-Touch™
W-52 (optional – indoor only)
Three-speed remote control with
full-range light dimming. Includes
wall plate bracket.

DIMENSIONS

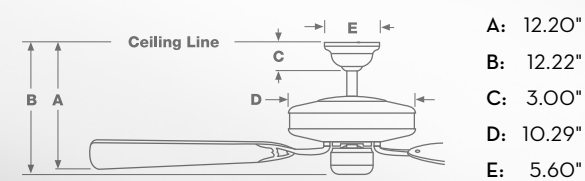

ENERGY INFORMATION AT HIGH SPEED

50" BLADE

Airflow: 6,611 cfm	Electricity Use: 86 w	Airflow Efficiency: 76.7 cfm/w
------------------------------	---------------------------------	--

42" BLADE

Airflow: 5,357 cfm	Electricity Use: 77 w	Airflow Efficiency: 69.3 cfm/w
------------------------------	---------------------------------	--

CONTINENTAL™

Casablanca brings the grand formality of the Beaux Arts period to today's homes with the Continental ceiling fan. This Damp-rated fan's faux alabaster light fixtures and botanical motif beautifully complement cast iron and aluminum outdoor furniture.



FEATURES

- XTR200™ 30mm motor / lifetime motor warranty
- ETL rated for damp or humid locations
- 60" blade span / 14° blade pitch
- Set of 5 exclusive outdoor carved featherwood blades included
- Moisture-resistant motor / stainless steel hardware
- Integrated 150-watt uplight with six 25w bulbs included
- Integrated 100-watt downlight with two 50w T4 halogen bulbs included
- Low Ceiling Adapter (LCA) is not compatible
- Requires additional hanging support (included)

CONTROL



4-Speed (F)
W-81 (included)
Four-speed wall control with dual-rotary system for full-range
light dimming and speed control

DIMENSIONS

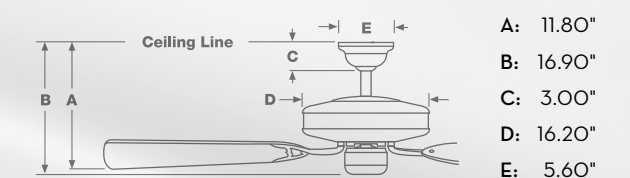

ENERGY INFORMATION AT HIGH SPEED

Airflow: 8,021 cfm	Electricity Use: 100 w	Airflow Efficiency: 80.4 cfm/w
------------------------------	----------------------------------	--

PORTABLE FANS



Zephyr™ portable fan



1928D Desk Fan
Matte Black with Satin Brass accents



19N8D Desk Fan
Matte Black with Satin Nickel accents

ZEPHAIR™

A richly detailed re-creation, the Zephyr uses modern technology to ensure Casablanca standards of exceptional performance and efficiency. The convenient carrying handle enables the desk fan to be moved comfortably.

FEATURES

- Lifetime motor warranty
- 9'6" cloth-covered cord
- Three fan speeds
- Cage separates easily for cleaning
- Die-cast base
- Ultra-quiet motor
- 55° oscillating sweep, 20° vertical adjustment

DIMENSIONS

Height:	Width:	Depth:	Blade Span:	Weight:
16.5 in	12.5 in	8 in	10.5 in	20 lb

PRODUCT SPECIFICATIONS

Speed:	Power:	Technology:
710-1,310 rpm	58-75 w	3-Speed

ACCESSORIES

BLADES

STANDARD-STYLE BLADES

BADGE-STYLE BLADES

ALL-WEATHER BLADES

SOUTH SEAS BLADE COLLECTION

AVALON BLADE SYSTEM

BEADBOARD BLADE COLLECTION

LIGHT FIXTURES

COMPLETE LIGHT FIXTURES

SOCKET-RING FITTERS AND GLASS

BOWL FITTERS AND BOWLS

THUMBSCREW FITTERS AND GLASS

LOW-PROFILE FITTERS AND GLASS

CONCERT BREEZE

CONTROL OPTIONS

HANGING SYSTEM



*Holliston ceiling fan (C31U73Z)
with Concert Breeze light fixture*



STANDARD-STYLE BLADES

Our standard blades are anything but, with specially constructed plywood layers to eliminate warping and a variety of stain and paint options. Blades are not for use in damp or wet locations.

COMPATIBLE FAN COLLECTIONS

Concentra, Panama, Panama Halo and Ventura

17" BLADE FINISHES

B304	Teak
B306	Mahogany
B307	Architectural White
B514	Walnut
B523	Hi-Gloss Snow White
B531	Classic White
B543	Matte Snow White
B544	Antique Oak

21" BLADE FINISHES

B201	Maple	B545	Antique Oak
B202	Mahogany	B561	Matte Snow White
B204	Architectural White	B562	Teak
B206	Dark Cherry	B563	Hi-Gloss Cherrywood
B207	Medium Oak	B564	Cherrywood
B210	Relic	B567	Hi-Gloss Rosewood
B213	Oil-Rubbed Bronze	B583	Hi-Gloss Snow White
B515	Walnut	B588	Matte Black
B537	Classic White	BS21-WD	Dark Walnut

BADGE-STYLE BLADES

All the same exceptional features of our standard fan blades, but compatible with even more fan styles. Blades are not for use in damp or wet locations.

COMPATIBLE FAN COLLECTIONS

Barlo, Brescia, Capistrano, Cottage, Metropolitan, New Orleans, Victorian and Wilderness.
Compatible with Estrada, Lanai and Utopian when used in a dry location.

17" BLADE FINISHES

B402	Mahogany
B416	Cherrywood
B419	Matte Snow White
B420	Walnut

21" BLADE FINISHES

B101	Maple	B507	Teak
B102	Mahogany	B508	Matte Black
B103	Walnut	B509	Matte Snow White
B107	Dark Cherry	B511	Hi-Gloss Snow White
B108	Medium Oak	B522	Antique Oak
B111	Relic	B541	Cherrywood
B500	Navajo White	BB21-WD	Dark Walnut

ACCESSORIES



ALL-WEATHER BLADES

Built exclusively for outdoor environments, these high-quality blades made with durable ABS plastic will withstand the elements, retaining their beauty for years to come.

17" BADGE-STYLE BLADE FINISHES

B817	Matte Snow White
B818	Matte Black
B821	Weathered Pine
B826	Dark Walnut

COMPATIBLE FANS

Estrada
Lanai
Utopian

21" BADGE-STYLE BLADE FINISHES

B717	Matte Snow White
B718	Matte Black
B719	Classic White
B721	Weathered Pine
B722	Rustic Iron
B726	Dark Walnut

COMPATIBLE FANS

Estrada
Lanai
Utopian

21" STANDARD-STYLE BLADE FINISHES

B527-11	Snow White
B527-DW	Dark Walnut

COMPATIBLE FANS

Panama Damp

SOUTH SEAS BLADE COLLECTION™

South Seas blades bring the option of tropical styling to any room. Blades are constructed with the highest quality materials and not only look great, but also provide optimum air movement at any fan speed.

DIMENSIONS

20 5/8" length
9" maximum width

BADGE-STYLE BLADE FINISHES

B28B-MG	Mahogany
B28B-WH	White

STANDARD-STYLE BLADE FINISHES

B28S-MG	Mahogany
B28S-TK	Teak
B28S-WH	White

COMPATIBLE FANS

Badge: Capistrano, Metropolitan
Standard: Concentra, Four Seasons III, Panama, Ventura



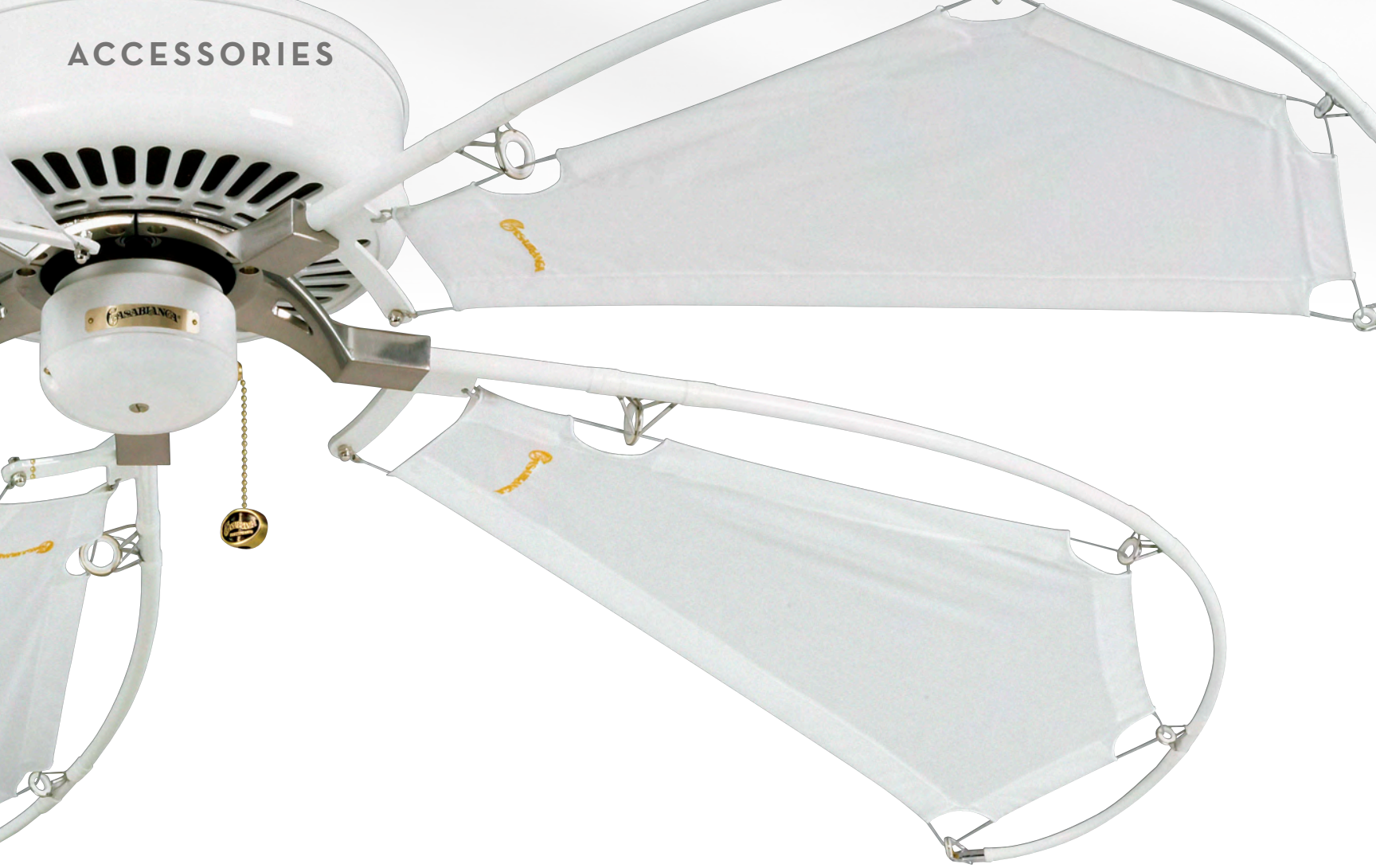

AVALON® BLADE SYSTEM

Avalon blades bring the option of nautical styling to a range of fan series. Blades are fabricated with ripstop sailcloth and tensioned by fiberglass fishing rods. Truly a Casablanca classic.

FEATURES

- 62" blade span / 18° blade pitch
- 29" long, 10" maximum width
- Ripstop nylon sailcloth blades
- Urethane coated with UV inhibitors
- Special hardware included
- Not for use with Low Ceiling Adapter (LCA)

BLADE FINISHES

BL31W-11 White rod with White fabric

COMPATIBLE FANS

Panama
Ventura



White

BEADBOARD BLADE COLLECTION

Beadboard blades add cottage-style comfort and charm to any compatible fan model. Their signature design draws its inspiration from vintage paneling. Not for use in damp or wet locations.

BLADE FINISHES

BBB21-72 Architectural White
BBB21-72D Distressed Architectural White

COMPATIBLE FANS

Capistrano
Cottage
Metropolitan



Architectural
White



Distressed
Architectural
White

LIGHT FIXTURES – GROUP A

COMPLETE LIGHT FIXTURES – GROUP A

INCLUDE FITTER AND GLASS



K4BA*
Four-Light Integrated CFL Bullet Fixture
52 watts
Available finishes:
Snow White (-11)
Brushed Nickel (-45)
Oil-Rubbed Bronze (-73)



KGC20
Three-Light Incandescent Fixture
180 watts (three 60w candelabra bulbs)
Designed by: Carly Kender
Available finishes:
Snow White / Opal glass (-11)
Brushed Nickel / Opal glass (-45)
Oil-Rubbed Bronze / Scavo glass (-73)
Brushed Cocoa / Scavo glass (-546)



KGC21
Banded Bowl Fixture
180 watts (three 60w candelabra bulbs)
Designed by: Carly Kender
Available finishes:
Snow White / Opal glass (-11)
Brushed Nickel / Opal glass (-45)
Oil-Rubbed Bronze / Opal glass (-73)
Brushed Cocoa / Faux Alabaster glass (-546)



KGC23
Glass Bowl Fixture
105 watts (three halogen bulbs)
Designed by: Carly Kender
Available finishes:
Snow White / Clear glass (-11)
Brushed Nickel / Clear glass (-45)
Oil-Rubbed Bronze / Scavo glass (-73)
Brushed Cocoa / Scavo glass (-546)



KG2WWA
Outdoor Incandescent Fixture
120 watts (two 60w candelabra bulbs)
ETL Rated for wet locations
Available finishes:
Classic White (-9)
Textured Matte Black (-89)



KG2LA
Outdoor Incandescent Fixture
120 watts (two 60w candelabra bulbs)
ETL Rated for wet locations
Available finishes:
Matte Black (-8)
Snow White (-11)
Navajo White (-26)
Rustic Iron (-46)
Washed Bronze (-49)
Oil-Rubbed Bronze (-73)
Brushed Cocoa (-546)
Restoration Bronze (-669)



KGC12A*
Outdoor Four-Light Integrated CFL Fixture
56 watts
ETL Rated for wet locations
Available finishes:
Brushed Cocoa (-546)
Bullion Black (-624)



KGC12W
Outdoor Four-Light Integrated Incandescent Fixture
160 watts (four 40w candelabra bulbs)
ETL Rated for wet locations
Available finishes:
Matte Black (-8)
Snow White (-11)

*Bulbs included with this light kit do not dim. If this light kit is installed on a fan with a light dimming function, then bulbs capable of dimming need to be purchased separately.

LOW-PROFILE FITTERS AND GLASS – GROUP A



K1CA
Integrated Halogen Fitter
100 watts
Available finishes:
Antique Brass (-4)
Classic White (-9)
Snow White (-11)
Brushed Nickel (-45)
Architectural White (-72)
Oil-Rubbed Bronze (-73)
Antique Pewter (-97)
Chrome (-199)
Bullion Black (-624)



K2CA
Integrated Incandescent Fitter
120 watts (two 60w candelabra bulbs)
Available finishes:
Bright Brass (-2)
Antique Brass (-4)
Matte Black (-8)
Classic White (-9)
Snow White (-11)
Navajo White (-26)
Weathered Copper (-32)
Brushed Nickel (-45)
Rustic Iron (-46)
Architectural White (-72)
Oil-Rubbed Bronze (-73)
Brushed Cocoa (-546)
Tuscan Bronze (-668)



G106
Seashell Low-Profile Glass
Use with K1CA or K2CA fitter (sold separately)



G107
White Marble Low-Profile Glass
Use with K1CA or K2CA fitter (sold separately)



G108
Scavo Low-Profile Glass
Use with K1CA or K2CA fitter (sold separately)



G109
White Frosted Low-Profile Glass
Use with K1CA or K2CA fitter (sold separately)



K2CA-45 two-light fixture with G108 Scavo Glass shown on Panama motor in Brushed Nickel (6645G) with B562 Teak blades



G110
Opal Low-Profile Glass with Accent
Use with K1CA or K2CA fitter (sold separately)

SOCKET-RING FITTER AND GLASS – GROUP A



K44TA*
Contemporary Four-Light
CFL Fitter
56 watts
Available finishes:
Antique Brass (-4) Architectural White (-72)
Snow White (-11) Oil-Rubbed Bronze (-73)
Brushed Nickel (-45) Chrome (-199)



CSG2
2 1/4" Side Glass with Square Shape
Amber Speckled



CSG5
2 1/4" Side Glass with Bell Shape
White Cased



CSG7
2 1/4" Side Glass with Bell Shape
Amber Linen



CSG15
2 1/4" Side Glass
Opal



CSG16
2 1/4" Side Glass
White

Complete light fixtures include White glass unless indicated otherwise.

THUMBSCREW FITTERS – GROUP A



K4SA*
Four-Light CFL Fitter for 2 1/4" Glass
56 watts
Available finishes:
Bright Brass (-2) Brushed Nickel (-45)
Antique Brass (-4) Architectural White (-72)
Matte Black (-8) Oil-Rubbed Bronze (-73)
Classic White (-9) Brushed Cocoa (-546)
Snow White (-11) Bullion Black (-624)
Weathered Copper (-32) Tuscan Bronze (-668)



K4SA Four-light fitter with G418 glass
shown on Brescia motor (9745) with
Hi-Gloss Snow White blades

*Bulbs included with this light kit do not dim. If this light kit is installed on a fan with a light dimming function, then bulbs capable of dimming need to be purchased separately.

THUMBSCREW GLASS – GROUPS A & B



G414
2 1/4" Side Glass
Frosted Tulip



G418
2 1/4" Side Glass
Frosted Deco



G420
2 1/4" Side Glass
Frosted Drapes



G601**
2 1/4" Side Glass
Flower-Cut Crystal



G606**
2 1/4" Side Glass
Diamond- and
Flower-Cut Crystal



G911**
2 1/4" Side Glass
Teck Antique



G912**
2 1/4" Side Glass
Opal Matte



G914**
2 1/4" Side Glass
Nuage Blanc Satin



G917**
2 1/4" Side Glass
White Satin

**Not compatible with KXXXF CFL fixtures

LIGHT FIXTURES – GROUP B

THUMBSCREW FITTERS – GROUP B



K4C
Williamsburg Four-Arm Center-Stem Incandescent Fitter for 2 1/4" Glass
240 watts
Available finishes:
Burnished Bronze (-92)



K134A*o
Four-Arm Center-Stem Swivel CFL Fitter for 2 1/4" Glass
56 watts
Available finishes:
Bright Brass (-2)
Antique Brass (-4)
Snow White (-11)
Brushed Nickel (-45)
Oil-Rubbed Bronze (-73)



K164A*o / K164Fo**
Four-Light Straight-Arm Center-Stem Fitter for 2 1/4" Glass
K164A - CFL / 56 watts
Available finishes:
Antique Brass (-4)
Snow White (-11)
Brushed Nickel (-45)
Architectural White (-72)
Oil-Rubbed Bronze (-73)
K164F - CFL / 52 watts (200 watt equivalent light output)
Available finishes:
Antique Brass (-4)
Classic White (-9)
Snow White (-11)
Brushed Nickel (-45)

*Fluorescent can only be used on pullchain fans; Energy Star® rated
oIncludes pullchain switch (not shown)

BOWL FITTER AND BOWLS – GROUP B



K2AA
Center-Stem CFL Fitter for Center Bowl Glass (medium base sockets)
28 watts



G208
White Marble Glass Bowl
Use with K2AA fitter (sold separately).
Bright Brass, Antique Brass, Snow White, and Brushed Nickel finials included

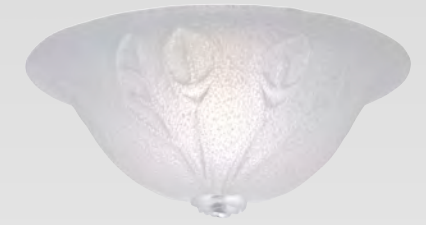

G213
Italian Leaf Glass Bowl
Use with K2AA fitter (sold separately)
Not for use with pullchain models unless equipped with optional controls.



G220
Italian Textured Glass Bowl
Use with K2AA fitter (sold separately)
Not for use with pullchain models unless equipped with optional controls.



G241
Alabaster Glass Bowl
Use with K2AA fitter (sold separately)
Not for use with pullchain models unless equipped with optional controls.



G242
Leaf Glass Bowl
Use with K2AA fitter (sold separately)
Not for use with pullchain models unless equipped with optional controls.

THUMBSCREW FITTERS AND 4" CENTER GLASS – GROUP B



K1KA*
CFL Fitter for 4" Center Glass
Only for use with G501 and G502 glass
14 watts
ETL Rated for damp locations
Available finishes:
Snow White (-11)
Brushed Nickel (-45)
Rustic Iron (-46)
Architectural White (-72)
Oil-Rubbed Bronze (-73)



G501
4" White Center Glass
Opal Schoolhouse
(K1K fixture sold separately)



G502
4" White Center Glass
Opal Mushroom
(K1K fixture sold separately)

* Bulbs included with this light kit do not dim. If this light kit is installed on a fan with a light dimming function, then bulbs capable of dimming need to be purchased separately.

COMPLETE LIGHT FIXTURES – GROUP B

INCLUDE FITTER AND GLASS



KG1KAo
Center-Stem Incandescent Pan Fixture White Frosted Glass
80 watts (two 40w candelabra bulbs)
Available finishes:
Antique Brass (-4)
Classic White (-9)
Snow White (-11)
Brushed Nickel (-45)
Architectural White (-72)
Oil-Rubbed Bronze (-73)
Brushed Cocoa (-546)



KG4WA*o
Shaker Four-Light CFL Fixture
56 watts
Available finishes:
Snow White / Frosted glass (-11)
Brushed Nickel / Frosted glass (-45)
Oil-Rubbed Bronze / Frosted glass (-73)
Brushed Cocoa / Amber glass (-546)

* Bulbs included with this light kit do not dim. If this light kit is installed on a fan with a light dimming function, then bulbs capable of dimming need to be purchased separately.
oIncludes pullchain switch (not shown)



CSLK-11
Snow White Concert Breeze Light Fixture
shown mounted to ceiling



CSLK-73
Oil-Rubbed Bronze Concert Breeze
Light Fixture shown on Panama 6673G

CONCERT BREEZE LIGHT FIXTURE

A light fixture and sound system all in one, the Concert Breeze mounts to most Casablanca fans, or directly to your ceiling. This groundbreaking Soundolier® technology utilizes an exclusive 2.4 GHz wireless system that's easily adapted to your television, stereo, MP3 player or any other audio source for 360 degrees of hi-definition sound.



FEATURES

- Mounts to most Casablanca ceiling fans or directly to ceiling
- CSLK-11 and CSLK-73 rated for damp locations
- CSLK-45 rated for indoor use only
- Compatible with many audio sources such as MP3 players, televisions and stereos
- Remote control included for separate operation of light and audio functions
- Integrated 120-watt bowl light fixture
- Includes three 40w candelabra bulbs

FINISHES

- CSLK-11 Snow White (Swirled Marble glass)
- CSLK-73 Oil-Rubbed Bronze (Italian Amber Scavo glass)
- CSLK-45 Brushed Nickel (Swirled Marble glass)

COMPATIBLE FANS

Academy	Cottage	Key Largo II	Utopian
Brescia*	Cottage Wet*	Lanai	Ventura
Capistrano*	Estrada	Panama*	Wailea
Concentra	Heritage**		

*Pullchain models only

**Compatible when used in indoor or damp locations only

CONTROL



Soundolier® Remote
To ensure things stay on the "cool" side, the system's hand-held credit-card-style wireless remote is a sleek addition to any technology seeker's desire to control the room's mood—both through sound volume and light brightness level.

SOUNDOLIER®
Integrated Wireless Technologies

CONTROL OPTIONS

INTEGRATED CONTROLS

With simple two-wire installation and intuitive Integrated Controls designed exclusively for – and included with – specific fan models, Casablanca fans are easy to install and even easier to use. The Integrated Controls include such features as adjustable fan speed and direction settings, lighting levels, and even home security, for total environmental enhancement.



Intel-Touch3® (W-84 Dual Light, W-85 Single Light)

This sophisticated wall-mounted system controls six fan speeds (in either the forward or reverse direction) and full-range light dimming for perfect room comfort and ambiance. Safe-Exit™ provides 20 seconds of gradual light dimming, showing you safely to the door. Home-Safe™ is a home security feature that controls lights in an irregular sequence, making a home appear occupied. The Fan Minder™ feature incrementally reduces fan speed, maintaining comfort at night. The Light Minder™ feature saves energy by turning lights off automatically after two hours.



W-74 SL



W-74 DL

Direct-Touch® (W-74SL, W-74DL)

Simple and straightforward, the Direct-Touch wall-mounted control offers four forward and reverse fan speeds, plus full-spectrum light dimming and advanced programmable features including Safe-Exit™, Home-Safe™, Fan Minder™ and Light Minder™. Includes CFL mode.



Advan-Touch® (W-63 Dual Light)

Wall-mounted or hand-held, Advan-Touch combines a user-friendly design with a large LCD display and intuitive controls for fan and lighting with programmable features. Advanced programmable features include Safe-Exit™ and Home-Safe™. Use one Advan-Touch to control several fans, or purchase an extra control to operate one fan from different locations. Includes wall plate bracket.



DC 6-speed

Six-speed control with full-range light dimming and reversing.



Versa-Touch2® (W-72 Single Light, W-73 Dual Light)

The refined Versa-Touch2 hand-held remote provides three forward and reverse fan speeds, full-spectrum light dimming and memory and has an optional wall plate bracket. Versa-Touch2 may be used alone to control several fans, or purchase extra controls to operate a single fan from different locations. Includes wall plate bracket.



Prime-Touch® (W-505)

This hand-held remote for select fans provides three forward and reverse fan speeds, full-spectrum light dimming and memory. Includes wall plate bracket.

ACCESSORY CONTROLS

Casablanca also offers a complete line of optional Accessory Controls, which allow homeowners to optimize the functionality of their fans based upon personal preferences. The Adapt-Touch™ control adds remote control convenience for 3-Speed and 4-Speed Casablanca fans with a Hang-Tru™ canopy. Casablanca also offers wall-mounted Accessory Controls for both fan and light control with either slide or rotary operation.



Intel-Touch3® (W-64 Dual Light, W-65 Single Light)

This sophisticated wall-mounted system controls six fan speeds (in either the forward or reverse direction) and full-range light dimming for perfect room comfort and ambiance. Safe-Exit™ provides 20 seconds of gradual light dimming, showing you safely to the door. Home-Safe™ is a home security feature that controls lights in an irregular sequence, making a home appear occupied. Includes wall plate bracket.



W-75SL



W-75DL

Direct-Touch® (W-75SL, W-75DL)

Simple and straightforward, the Direct-Touch remote control offers four forward and reverse fan speeds, plus full-spectrum light dimming and advanced programmable features including Safe-Exit™, Home-Safe™, Fan Minder™ and Light Minder™. Includes a CFL mode.



Adapt-Touch™ (W-52)

Add remote control convenience to Casablanca 3-Speed and 4-Speed models. Adapt-Touch easily converts new or existing Casablanca 3-Speed and 4-Speed pullchain models equipped with a Hang-Tru® canopy to remote control operation. Features include three fan speeds, instant off and full-range light dimming (on models equipped with a light fixture), all from the palm of your hand. The hand-held remote includes a switch plate bracket for wall mounting, and the receiver is quickly installed in the Hang-Tru® canopy. Use one Adapt-Touch to control several fans, or purchase extra controls to operate a fan from different locations. Note: The W-52 is not recommended for use in outdoor locations.



WRF3-XX

Three-speed remote control with full-range light dimming and reversing. Compatible with Four Seasons III and Four Seasons III Hugger.



W-41



W-81

Single and Dual Rotary Controls (W-41, W-81)

Optional accessory for 3-Speed and 4-Speed models with XTR200 and XLP-2000 motors. Provides four separate fan speeds, an industry exclusive. Noise-free circuitry and quiet operation (Almond and White included). Dual rotary control W-81 also provides full-range light dimming and requires third wire for installation.



W-24



W-28

Single and Dual Slide Controls (W-24A, W-24W, W-28A, W-28W)

Optional accessory for 3-Speed and 4-Speed models. Provides four fan speeds. Noise-free circuitry and quiet operation. Not for use on XTR200 motors. (Almond or White). Dual slide control W-28A and W-28W also provide full-range light dimming and requires third wire for installation.

HANGING SYSTEM

Casablanca makes installation a do-it-yourself, one-person operation. Casablanca's patented Hang-Tru® hanging system supports the fan from the ceiling, leaving both hands free to make wiring connections. The self-centering ball makes sure the fan hangs straight, even on ceilings with up to 32-degree slope (for greater slopes, use a Sloped Ceiling Adapter).

Casablanca's threaded Perma-Lock™ downrod locks the fan permanently in place and is the sturdiest, easiest to install downrod on the market. Higher ceilings? Casablanca offers optional downrods in lengths up to 96" to satisfy virtually any installation requirement.

EXTRAS INCLUDED

Everything you need is included with your Casablanca fan, including light bulbs, batteries for remotes, and even a handy screwdriver. Casablanca delivers "Quality In Every Detail.™"

LOW CEILING ADAPTER (LCA-*)

LCA-* (limited finishes). Reduces fan height by 3 1/2" from standard downrod (3" for Direct Drive models). (Canopy measures 2"H x 6.25" diameter).

NOT for use with Academy, Academy Gallery, Alexandria, Atria, Barolo, Bel Air, Bel Air Halo, Bungalow, Candelier II, Continental, Four Seasons III Hugger, Holliston, Isotope, La Fleur, Le Grande, Malibu Star, Marrakesh, Mission, Modena II, New Orleans Centennial, 19th Century, Panama Halo, S3, Siena, Silhouette II, Stealth, Twain, Trident, Vermont, Verrazano, Vita, Whitman, or Wilderness fans or Avalon blades. Also not for use with Cottage Wet, Estrada, Four Seasons III Outsider, Heritage, Lanai, Panama Damp, Utopian, or Wailea when installed in a damp or wet location.



Low Ceiling Adapter (LCA)

SLOPED CEILING ADAPTER (SCA-P)

Use Model SCA-P for slopes from 32 degrees to 56 degrees.

If using the SCA-P with Academy, Academy Gallery, Bungalow, Holliston, Mission, Modena II, S3, Star, Starlet, Verrazano, Vita or Whitman, you must purchase a Hang-Tru® canopy (Part #192220xx); specify finish to match fan. Use hanger pack included with fan.



Sloped Ceiling Adapter (SCA)

PERMA-LOCK™ DOWNRODS

FAN MODELS

Academy	Continental	Marrakesh (6" std.)	Tercera
Academy Gallery	Cottage	Metropolitan	Trident
Antion	Cottage Wet	Mission	Twain
Alessandria (5" std.)	Estrada	Modena II	Utopian
Atria (4" std.)	Four Seasons III	New Orleans Centennial	Veneto (11" std.)
Barolo	Four Seasons III Gallery	19th Century (12" std.)	Ventura
Bel Air	Four Seasons III Outsider	Panama	Verrazano (6" std.)
Bel Air Halo (7" std.)	Heritage (5" std.)	Panama Damp	Vicente (11" std.)
Brescia	Holliston (3" std.)	Panama Halo	Victorian
Bungalow (3" std.)	Key Largo II (3" std.)	S3	Vita (5" std.)
Candelier II (9" std.)	Lanai	Siena (3" and 6" std.)	Wailea
Capistrano	La Fleur (5" std.)	Star	Whitman (5" std.)
Colorado (12" std.)	Le Grande	Starlet	Wilderness (6" std.)
Concentra	Malibu Star (12" std.)	Stealth	

19TH CENTURY OUTER SLEEVE (RS69XX)

Sleeve must be ordered with appropriate extension pipe:

8" sleeve for 12" pipe, 14" sleeve for 18" pipe, 20" sleeve for 24" pipe, 26" sleeve for 30" pipe, 32" sleeve for 36" pipe, 44" sleeve for 48" pipe, 56" sleeve for 60" pipe, 68" sleeve for 72" pipe.

EXTENSION DOWNROD LENGTHS (MODEL PL*XX)

6", 12", 18", 24", 36", 48", 60", 72" and 96" (*= finish to match fan, xx= downrod length). See ceiling height/downrod length guide below.

SUGGESTED EXTENSION DOWNRODS

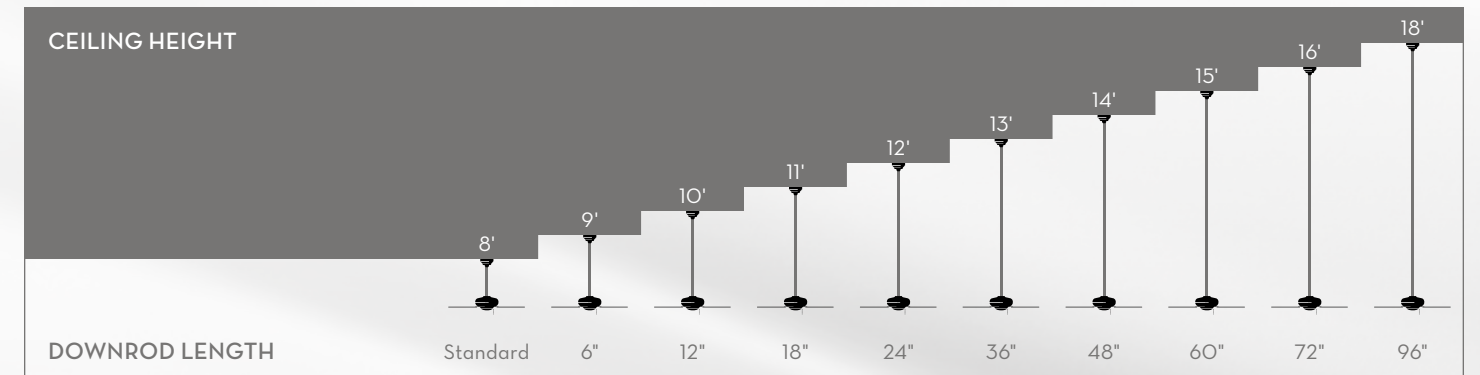

Note: For best performance and appearance, an extension downrod should be used with your Casablanca fan when installing on a high or sloped ceiling. Casablanca offers extension downrods in lengths up to 8' (96"). The chart lists the most common ceiling heights and suggested downrod lengths. For safety reasons, the fan blades must be a minimum of 7 feet above the floor. For more information, see your Casablanca dealer.

Gallery Edition models include coordinating blades, light fixture and glass. Fans with the notation "Requires Additional Hanging Support" are packaged with the necessary hardware.

FAN FINISHES



Bright Brass (-2)



Antique Brass (-4)

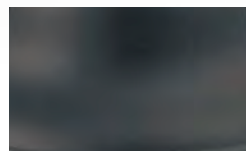

Matte Black (-8)



Classic White (-9)



Distressed Classic White (-9D)

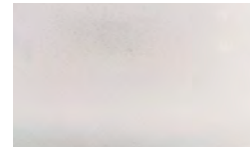

Snow White (-11)

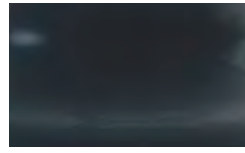

Hi-Gloss Black (-12)



Navajo White (-26)



Weathered Copper (-32)



Brushed Nickel (-45)



Rustic Iron (-46)



Washed Bronze (-49)

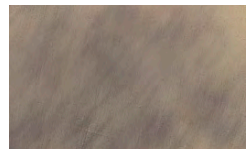

Bronze Patina (-52)

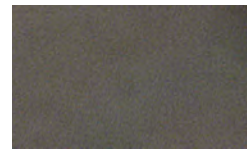

Amber Bronze (-55)



French Crème (-61)



Tuscan Sunset (-63)

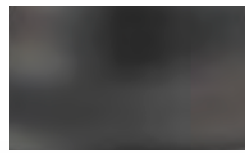

Graphite (-68)



Burnished Brass (-69)



Architectural White (-72)

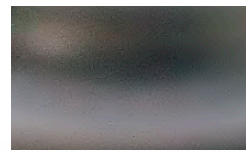

Oil-Rubbed Bronze (-73)



Textured Matte Black (-89)

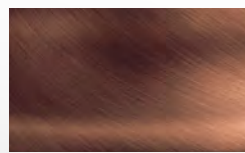

Burnished Bronze (-92)



Antique Pewter (-97)

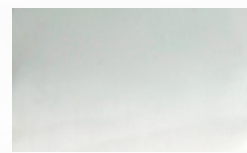

Chrome (-199)



Aged Bronze (-500)

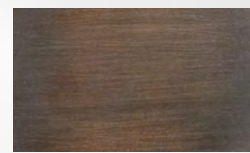

Brushed Cocoa (-546)

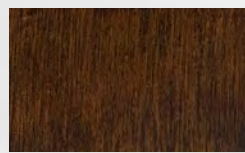

Northern Sienna (-611)

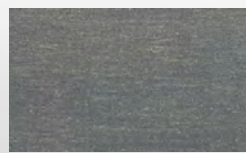

Bullion Black (-624)

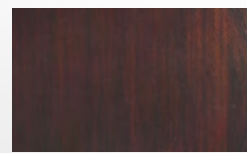

Cherry Bronze (-667)

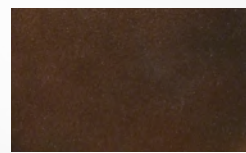

Tuscan Bronze (-668)



Restoration Bronze (-669)

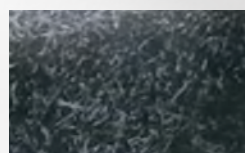

Normandy (-700)



Iron Ore (-707)

BLADE FINISHES



Antique Oak
(Matte or Hi-Gloss)



Architectural White

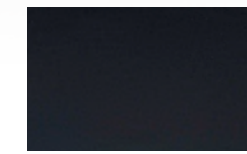

Black
(Matte, Glossy, or All Weather)



Bleached Oak
(also available in All-Weather)



Brushed Cocoa

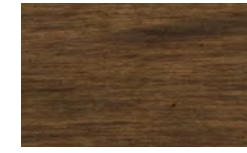

Brushed Walnut



Carbon Fiber

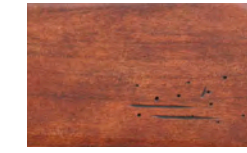

Cherry Relic



Cherrywood
(Matte or Hi-Gloss)



Classic White
(also available in All-Weather)



Clove

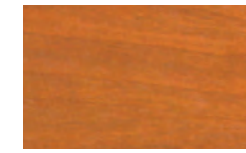

Dark Cherry

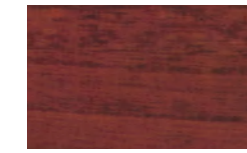

Dark Walnut



Distressed
Architectural White



Distressed White



Espresso



Graphite



Light Oak



Mahogany



Maple



Medium Oak

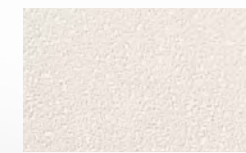

Navajo White



Oil-Rubbed Bronze



Platinum

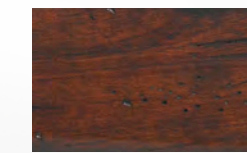

Reclaimed Antique



Relic

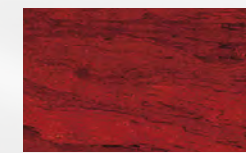

Rosewood
(Matte or Hi-Gloss)



Rustic Iron
(also available in All-Weather)

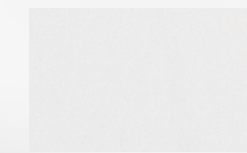

Snow White
(Matte, Glossy, or All Weather)

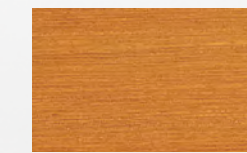

Teak



Textured Matte Black

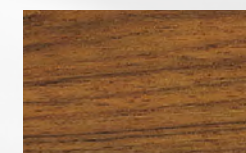

Walnut
(Matte)

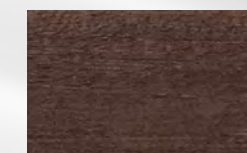

Washed Bronze

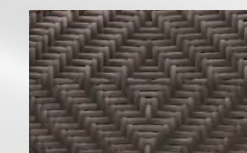

Weathered Bronze Wicker

BLADE SELECTION REFERENCE CHART

Casablanca blades are constructed of the finest materials to ensure long-lasting durability, high-quality appearance, and smooth, wobble-free performance. The blades on every Casablanca fan are inspected, matched for color and finish, and weighed to within one gram before being packaged as a set. These time-consuming steps are an essential component of Casablanca's uncompromising approach to quality. For outdoor use, Casablanca offers "All-Weather" specialized molded blades with high-impact synthetic resins that will not warp.

BLADE TYPE	BASIC				DELUXE	ALL-WEATHER			EXCLUSIVE		
	17"	17"	21"	21"	21"	16"	21"	21"	Bel Air	Heritage	Stealth
	Badge	Standard	Badge	Standard	Badge Beadboard	Badge	Badge	Standard			
COMPATIBLE FAN SERIES	Barolo		Barolo		Barolo						
	Brescia		Brescia		Capistrano						
	Capistrano		Capistrano		Cottage						
	Cottage	Concentra	Cottage		Metropolitan						
	Metropolitan	Panama Halo	Metropolitan		Metropolitan						
	New Orleans	Panama 4-S	Reverie	Concentra	New Orleans	Estrada	Estrada				
	Victorian	Panama 4-S	Victorian	Panama Halo	Victorian	Lanai	Lanai	Four Seasons Outsider	Bel Air		
		Ventura	Wilderness	Ventura	Wilderness	Utopian	Utopian	Panama Damp	Bel Air Halo	Heritage	Stealth
Antique Oak		B544	B522	B545							
Architectural White		B307		B204	BBB21-72					B32-72	
Cherrywood	B416		B541	B564							
Classic White		B531		B537			B719				
Dark Cherry			B107	B206				B619		B32-DC	
Dark Walnut			BB21-WD	BS21-WD		B826	B726	B527-DW	B621	B32-DW	
Distressed Architectural White					BBB21-72D						
Glossy Black										B32-12	
Graphite										B32-68	
Hi-Gloss Cherrywood				B563					B615		
Hi-Gloss Rosewood				B567							
Hi-Gloss Snow White		B523	B511	B583					B611	B32-11	
Light Oak				B535							
Mahogany		B306	B102	B202					B618		
Maple			B101	B201							
Matte Black			B508	B588		B818	B718				
Matte Snow White	B419	B543	B509	B561		B817	B717	B527-11			
Medium Oak			B108	B207							
Navajo White			B500								
Oil-Rubbed Bronze				B213							
Platinum										B32-79	
Reclaimed Antique										BL-ADK-RA	
Relic			B111	B210							
Rustic Iron							B722				
Teak		B304	B507	B562							
Walnut	B420	B514	B103	B515					B622		
Washed Bronze											
Weathered Bronze Wicker										BL-TPW-WB	
Weathered Pine						B821	B721				

ADDITIONAL BLADE OPTIONS:
South Seas Collection (page 121) / Avalon Blade System (page 122)

LIGHT FIXTURE REFERENCE CHART

	Bright Brass	Antique Brass	Matte Black	Classic White	Snow White	Navajo White	Weathered Copper	Brushed Nickel	Rustic Iron	Washed Bronze	Tuscan Sunset	Burnished Brass	Architectural White	Oil-Rubbed Bronze	Textured Matte Black	Burnished Bronze	Antique Pewter	Chrome	Antique Pewter	Brushed Cocoa	Bullion Black	Tuscan Bronze	Restoration Bronze	Bulb Specification	Pulldown Switch	Height †	Width † †	Hanging Weight † † †		
	-2	-4	-8	-9	-11	-26	-32	-45	-46	-49	-63	-69	-72	-73	-89	-92	-97	-199	-500	-546	-624	-688	-689			5 1/2"	10 1/4"	5 lbs		
GROUP A																														
K4BA																									Four 13W medium base CFL bulbs		9"	23"	2 lbs	
KG20																									Three 60W type G16.5 candelabra bulbs					
KG21																									Three 60W type G16.5 candelabra bulbs					
KG23																									Three pin-based 35W halogen bulbs					
KG2WVA Wet																									Two 60W type G16.5 candelabra bulbs		5 1/2" *	10 1/4" *	4 lbs	
KG2LA* Wet																									Two 60W type G16.5 candelabra bulbs		5 1/2" *	10 1/4" *	4 lbs	
KG12A Wet																									Four 14W medium base CFL bulbs					
K1CA***																									One 100W Q100FR/MC Mini-Can halogen bulb		5 1/2"	10 1/4"	5 lbs	
K2CA																									Two 60W type B10 candelabra bulbs		7 1/4" *	12 1/2" *	5 lbs	
K44TA																												9" *	18" *	4 lbs
K4SA																									Four 14W medium base CFL bulbs		5 1/2" *	17 1/2" *	4 lbs	

GROUP B																													
K4C																									Four 60W type B10 candelabra bulbs		6"	11" to 18"	3 lbs
K134A																									Four 14W medium base CFL bulbs		7 1/2"	8 1/4" to 21"	7 lbs
K164A																									Four 14W medium base CFL bulbs		8"	17"	7 lbs
K164F																									Four 13W 4-pin PLS13 CFL bulbs		6 1/2"	13"	4 lbs
K1KA*																									One 14W medium base CFL bulb		3 1/4"	8 1/4"	2 lbs
K2AA																									Two 14W medium base CFL bulbs		5 1/2"	10 1/4"	5 lbs
KG1KA																									Two 40W type G16.5 candelabra bulb		5" *	10 1/2" *	3 lbs
KG4WA																									Four 14W medium base CFL bulbs		9 3/4" *	15 1/4" *	10 lbs

EXCLUSIVE LIGHT KITS																													
19th Century Exclusive KG99A																									Four 14W medium base CFL bulbs		8 1/2"	15 1/2"	4 lbs
Barolo Exclusive KG5																									Three 60W type G16.5 candelabra bulbs		7 1/2"	17 3/4"	6.5 lbs
Brescia Exclusive KG1N																									Three 60W type B10 candelabra bulbs		5 1/2" **	16" **	4 lbs
Le Grande Exclusive KG1M***																									One 100W Q100FR/MC Mini-Can halogen bulb		8 1/8" **	7 3/4" **	3 lbs
Marrakesh Exclusive KG89																									One 100W Q100FR/MC Mini-Can halogen bulb		6 1/2"	12"	7 lbs
Key Largo II Exclusive KG87																									Three 60W type C35 medium base bulbs		8"	13"	5 lbs
Wilderness Exclusive KG86																									Three 60W candelabra blunt-tip bulbs		12 1/2"	18"	6 lbs
Heritage Exclusive KG10A* Wet																									One 100W T2.5 halogen bulb		7 5/8"	9 1/8"	8 lbs

* Height, measured with a typical glass piece. Height may vary.
 ** Width, measured with a typical glass piece. Width may vary.
 *** Hanging weight, including weight for typical glass. Weight may vary. Rounded to the nearest pound.
 * Measurement listed is with actual glass installed.

CEILING FAN SPECIFICATIONS

SERIES	Model Number (x, xx, or xxx = Finish Code)	Dimensions (in inches)					Blade Pitch
		A	B	C	D	E	
Academy	C38UXX	12	14.5	3	13.7	6.7	14°
Academy Gallery	C38GXX	12	19.5	3	13.7	6.7	14°
Alessandria	C27GXH	11.88	17.57	3	13.74	7	14°
Antion	C39G199L	11.74	16.08	3.4	18.06	7.61	14°
Atria	C18G500F	23.4	28.8*	3	17.1	5.6	11°
Barolo†	C5SXXZ	11	13	3	13	5.6	14°
Bel Air	38XXZ	9.25	13.9*	3	12.25	5.6	14°
Bel Air Halo	38DHXXZ	13.25	18.5*	3	15.5	5.6	14°
Brescia†	95XD/Z	11.3	12.6	3	14	5.6	15°
Bullet	C43GXXXL	21.22	24.77	3.18	8.08	7.02	14°
Bungalow	P4M55H	11	17*	3	14	7.7	13°
Candelier II	C16G73L	24.37	24.37	4.82	10.93	8	20°
Capistrano†	46XXD/M	11.1	12.75	3	12.6	5.6	16°
Colorado	C42GXXXL	21.1	30.23	3.4	14	7.6	14°
Concentra†	49XD	11	12.75	3	11.5	5.6	16°
Continental	C20G624F	11.8	16.9*	3	16.2	5.6	14°
Cottage†	C12G72M	12	13	3	13.3	5.6	15°
Cottage Wet	C12DXXD	12	13	3	13.3	5.6	15°
Estrada††	47XXD	13	13.75	3	12	5.6	15°
Four Seasons III, 52"	84UXXD	10.75	12.75	3	11.5	5.6	13°
Four Seasons III, 42"	74UXXD	10.75	12.75	3	11.5	5.6	13°
Four Seasons III Gallery	84GXXD	13	25*	3	11.5	5.6	13°
Four Seasons III Hugger, 52"	82UXXD	7	8	N/A	11	5.6	12°
Four Seasons III Hugger, 42"	72UXXD	7	8	N/A	11	5.6	12°
Four Seasons III Outsider	83UXXD	10.75	12.75	3	11.5	5.6	13°
Heritage (with BL-ADK-RA blades)	C19XXF	12.7	13.4	2.9	16	5.6	14°
Heritage (with BL-TPW-WB blades)	C19XXF	13.3	13.4	2.9	16	5.6	14°
Holliston	C31UXXZ	11.8	13.4	2.8	13.9	6.7	15°
Holliston DC	C31UXXB	11.68	13.14	2.8	13.9	6.7	15°
Isotope, 52"	C30GXXH/L	9.5	12.8	N/A	10.2	7.7	14°
Isotope, 44"	C35GXXH/L	9.5	12.8	N/A	10.2	7.7	14°
Key Largo II	C23U73K	12.3	13.01	2.83	13.14	5.56	15°
La Fleur	P2GXXX	12	22*	3	12	5.6	15°
Lanai††	79XXD	11.1	12.75	3	12.6	5.6	16°
Le Grande	85UXXM	11.96	16.23	3	8.69	5.6	14°
Malibu Star	23B002	21	23	3	6.25	5.6	15°
Marrakesh	89UXXM	13.25	20*	4	19.75	5.6	14°
Metropolitan†	64XXZ	12	12.2	3	12	5.6	15°
Mission	970XXZ	11	15.4*	3	13.9	7.7	13°
Modena II	C10GXXM	11.83	16.75*	3	8.17	7.7	dynamic
New Orleans Centennial†	69XXD	26	28	3	13	5.6	15°
19th Century	99UXXZ	22	28.5*	6.75	10.5	5.6	14°
Panama†	66XXZ	10.75	12.46	3	13.43	5.6	15°
Panama 4-Speed†	66XXG	10.75	12.46	3	13.43	5.6	15°
Panama Damp††	66DXXG	10.75	12.46	3	13.43	5.6	15°
Panama DC	C66UXXB	11.22	12.13	3	12	5.6	15°
Panama Energy Star	C66XXL	12	13.38	3.4	12	7.61	15°
Panama Halo†	66HXXF	10.75	12.46	3	13.43	5.6	20°
S3	930XXM	9.8	14*	3	10.2	7.7	15°
Siena	P5G73M	11	23*	3	18	5.6	15°
Silhouette II	C2MXXXM	10.24	12.53	NA	NA	24	15°
Star	C28GXXM	11.77	14.35*	3	8.09	7.7	15°
Starlet	C29GXXM	11.77	14.35*	3	8.09	7.7	15°
Stealth	32XXZ	10.75	13.25*	3	11.5	5.6	14°
Stealth DC	C45GXXB	10.75	13.25	3	11.5	5.6	14°
Tercera	C22GXXL	11.94	14.35	3.37	12.94	7.61	15°
Trident	TRIH-XX	12	15	3.25	11.4	5.6	14°
Twain	C25G624F	11.9	16.7*	3	16.2	5.6	14°
Utopian††	77XXD	12.2	12.22	3	10.29	5.6	16°
Veneto	C15GXXL	17.75	25.75	3.4	19.7	7.6	13°
Ventura	67XD	11	12.5	3	10.25	5.6	16°
Vermont	C34GXXM	9.7	13.7	N/A	NA	15.4	15°
Verrazano	65G45D	22.5	25.5*	3	9.5	7.7	13°
Vicente	C32G611L	20.07	25.67	3.36	14.17	7.61	15°
Victorian†	63XXZ	11.5	13.5	3	13	5.6	15°
Vita	C17GXXA	11.6	16.5*	2.7	13	7	13°
Wallea	41UXXD	11.34	11.93	3	8.5	5.6	25°
Whitman	C21GXXH	11.76	17.26	3	13.1	5.6	14°
Wilderness	86U89M	16	17	3	11.8	5.6	14°

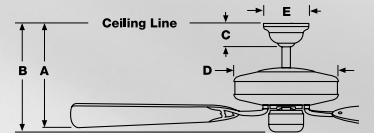

Dimension B with * = measurement including Light Fixture and Glass

Dimension B without * = measurement to bottom of Switch Housing

** = at highest speed

Energy measurements taken with included or exclusive blades unless noted otherwise.
† Energy measurements taken with 21" basic blades
†† Energy measurements taken with 21" All-Weather blades

Blade Span		Weight (lbs.)	Min. Ceiling Height (ft.)	Energy Information (at High Speed)				Motor Size	Technology and Fan Controls
Long	Short			Speed (rpm)	Airflow (cfm)	Electricity Use (watts)	Airflow Efficiency (cfm/watt)		
54"		25	8	175	5,878	75	79	172mm x 20mm	4-S
54"		29	8	175	5,878	75	79	172mm x 20mm	4-S
54"		29	8	170	6,000	75	80	172mm x 20mm	P•T W-505
52"		31	8	189	5,551	68	81.4	172mm x 20mm	D•T W-74SL
68"		42	9	156	9,042	93	97.4	XTR200 - 30mm	4-S W-81
52"	44"	37	8	195	6,059	104	58.2	XLP-2000 - 28mm	I•T3 W-85
55"		24	8	176	7,174	119	60.5	XLP-2000 - 28mm	I•T3 W-85
55"		36	9	176	7,174	119	60.5	XLP-2000 - 28mm	I•T3 W-84
52"	44"	27	8	182	6,591	116	56.9	XLP-2000 - 28mm	I•T3 W-85
54"		33	8	179	5,983	68	87	172mm x 20mm	D•T W-74SL
56"		38	8	180	6,193	73	84.6	188mm x 20mm	P•T W-505
30"		150	9	300	2,920	66	44	XLP-2000 - 28mm	D•T W-74DL
53"		21	8	190	6,691	89	75.2	188mm x 20mm	V•T2 W-72 / 3-S
60"		35	9	164	6,944	94	74.2	188mm x 20mm	D•T W-74SL
50"	42"	20	8	200	6,727	89	75.8	188mm x 20mm	3-S
60"		47	8	177	8,021	100	80.4	XTR200 - 30mm	4-S W-81
52"	44"	28	8	190	6,482	84	77	188mm x 20mm	V•T2 W-72
52"		18	8	190	6,361	82	77.3	188mm x 20mm	3-S
52"	44"	25	8	203	6,734	89	75.3	188mm x 20mm	3-S
52"		14	8	168	5,114	68	74.3	172mm x 12mm	3-S
	42"	14	8	250	4,134	59.5	69.5	172mm x 12mm	3-S
52"		14	8	168	5,100	80	63.8	172mm x 12mm	3-S
52"		11	8	157	2,126	67	31.8	172mm x 12mm	3-S
42"		11	8	230	2,400	62	38.7	172mm x 12mm	3-S
52"		17	8	168	5,439	60	90.7	172mm x 12mm	3-S
60"		39	9	167	7,932	96.4	82.3	XTR200 - 30mm	4-S W-81
60"		47	9	155	6,736	99.3	67.8	XTR200 - 30mm	4-S W-81
60"		22	8	173	6,494	115	56	XLP Plus - 40mm	I•T3 W-84
60"		22	8	138	7,087	30.8	230	165 DC	DC
52"		28	8	204	3,135	71	43.8	188mm x 20mm	P•T W-505/D•T W-74SL
44"		28	8	278	3,915	73	53.6	188mm x 20mm	P•T W-505/D•T W-74SL
52"		8	8	190	4,251	74	57.5	188mm x 20mm	4-S
56"		33	8	135	5,909	69	86	188mm x 20mm	P•T W-505
53"	45"	25	8	215	6,790	90	75	188mm x 20mm	3-S
62"		27	8	156	6,674	86	78	188mm x 20mm	V•T2 W-72
84"		19	9	83	5,170	109	47.4	XLP-2000 - 28mm	4-S W-81
64"		40	9	175	7,852	92	85	188mm x 20mm	V•T2 W-72
52"	44"	25	8	175	6,003	119	50.5	XLP-2000 - 28mm	I•T3 W-85
56"		36	8	153	6,162	102	60.5	XLP-2100 - 33mm	I•T3 W-85
47"		28	8	187	5,832	72	81	188mm x 20mm	V•T2 W-72
54"	46"	36	10	152	6,005	103	58.1	XLP-2000 - 28mm	3-S
54"		35	9	169	6,050	108	56.2	XLP-2000 - 28mm	I•T3 W-85
50"	42"	20	8	194	5,226	106	49.3	XLP-2000 - 28mm	I•T3 W-85
50"	42"	27	8	201	6,153	104	59	XLP-2000 - 28mm	4-S
50"		27	8	201	6,226	108	57.6	XLP-2000 - 28mm	4-S
54"		19	8	170	6,416	32	199.3	165 DC	DC
50"	42"	20	8	206	6,238	83	75.2	188mm x 20mm	D•T W-74SL
50"	42"	27	8	150	6,522	82	79.5	XTR200 - 20mm	4-S
54"		23	8	202	7,440	86	89.8	188mm x 20mm	V•T2 W-72
54"		45	8	120	4,680	67	69.7	188mm x 25mm	V•T2 W-73
52"		30	8	140	4,739	68.7	69	188mm x 20mm	V•T2 W-72
52"		27	8	201	5,640	67	84	172mm x 20mm	V•T2 W-72
36"		20	8	285	3,074	50	62	153mm x 12mm	V•T2 W-72
54"		33	8	172	6,115	110	55.6	XLP-2000 - 28mm	I•T3 W-85
54"		31	8	185	6,554	30	218	165 DC	DC
52"		30	8	208	5,476	63.3	86.5	172mm x 20mm	D•T W-74SL
54"		19	8	220	6,694	72	92.7	188mm x 20mm	P•T W-505
60"		45	8	157	8,173	97	84.3	XTR200 - 30mm	4-S W-81
50"	42"	25	8	200	6,611	86	76.7	172mm x 20mm	3-S
68"		48	9	106	7,296	101	73	172mm x 18mm	W-74DL
50"/62"	42"	19	8	189	6,105	106	57.8	XLP-2000 - 28mm	3-S
54"		35	8	138	4,406	83	53	188mm x 20mm	V•T2 W-72
54"		32	10	165	4,809	94.9	50.7	XLP-2000 - 28mm	4-S W-1811
56"		38	8	156	6,537	84	77.9	188mm x 25mm	D•T W-74DL
54"	46"	23	8	220	6,250	122	51	XLP-2000 - 28mm	I•T3 W-85
52"		39	8	208	6,885	120	57.6	XLP Plus - 38mm	A•T W-63
31"		17	8	255	3,127	51	61.9	153mm x 20mm	3-S
54"		36	8	150	5,627	70	80.4	172mm x 20mm	P•T W-505
54"		50	9	215	6,772	90	75	188mm x 20mm	V•T2 W-73

Technology:
3-S = Three Speed
I-T = Intelli-Touch
4-S = Four Speed
P-T = Prime-Touch
A-T = Advan-Touch
V-T2 = Versa-Touch2
D-T = Direct-Touch
DC = DC 6-speed

INDEX IN NUMERICAL ORDER

Model #	Description	Page	Model #	Description	Page
1928D	Zephair Desk Fan	114	C12S72M	Cottage	92
19N8D	Zephair Desk Fan	115	C15G624L	Veneto	39
23BOO2	Malibu Star	75	C16G73	Candelier II	10-11
32XXZ	Stealth	62-63	C17GXXXA	Vita	70-71
38DHXXXZ	Bel Air Halo	52-53	C18G500F	Atria	104
38XXXZ	Bel Air	50-51	C19XXXF	Heritage	98-99
41UXXD	Wailea	106-107	C20G624F	Continental	111
46XXD/M	Capistrano	54-55	C21GXXXH	Whitman	48-49
47XXD	Estrada	108	C22GXXL	Tercera	67
49XXXD	Concentra	32-33	C23U73K	Key Largo II	93
63XXZ	Victorian	14	C25G624F	Twain	109
64XXZ	Metropolitan	56-57	C27GXXXH	Alessandria	16
65G45D	Verrazano	77	C28GXXM	Star	72
66DXXG	Panama Damp	103	C29GXXM	Starlet	73
66HXXF	Panama Halo	26-27	C2M72M	Silhouette II	83
66XXG/Z	Panama	22-23	C30GXXXH/L	Isotope, 52"	80-81
67XXD	Ventura	34-35	C31UXXXB	Holliston DC	42
69XXD	New Orleans Centennial	17	C31UXXXZ	Holliston	40-41
72UXXD	Four Seasons III Hugger, 42"	84-85	C32G611L	Vicente	18
74UXXD	Four Seasons III, 42"	28-29	C34G546M	Vermont	82
77XXXD	Utopian	110	C35GXXXH/L	Isotope, 44"	80-81
79XXXD	Lanai	100-101	C38GXXXK	Academy Gallery	46-47
82UXXD	Four Seasons III Hugger, 52"	84-85	C38UXXXK	Academy	44-45
83UXXD	Four Seasons III Outsider	105	C39G199L	Antion	66
84GXXD	Four Seasons III Gallery	30-31	C42GXXXL	Colorado	38
84UXXD	Four Seasons III, 52"	28-29	C43GXXXL	Bullet	65
85UXXM	Le Grande	74	C45GXXXB	Stealth DC	64
86U89M	Wilderness	95	C5S63Z	Barolo	19
89UXXXM	Marrakesh	90-91	C66UXXXB	Panama DC	24
93OXXM	S3	68	C66XXXL	Panama Energy Star	25
95XXXD/Z	Brescia	58-59	P4M55H	Bungalow	89
97OXXZ	Mission	88	P5G73M	Siena	43
99U69Z	19th Century	15	PCGXXXH	La Fleur	94
C10GXXXM	Modena II	76	TRIH-XX	Trident	69
C12DXXD	Cottage Wet	102			

INDEX IN ALPHABETICAL ORDER

Description	Model #	Page	Description	Model #	Page
19th Century	99U69Z	15	Malibu Star	23BOO2	75
Academy	C38UXXXK	44-45	Marrakesh	89UXXXM	90-91
Academy Gallery	C38GXXXK	46-47	Metropolitan	64XXZ	56-57
Alessandria	C27GXXXH	16	Mission	97OXXZ	88
Antion	C39G199L	66	Modena II	C10GXXXM	76
Atria	C18G500F	104	New Orleans Centennial	69XXD	17
Barolo	C5S63Z	19	Panama	66XXG/Z	22-23
Bel Air	38XXXZ	50-51	Panama Damp	66DXXG	103
Bel Air Halo	38DHXXXZ	52-53	Panama DC	C66UXXXB	24
Brescia	95XXXD/Z	58-59	Panama Energy Star	C66XXXL	25
Bullet	C43GXXXL	65	Panama Halo	66HXXF	26-27
Bungalow	P4M55H	89	S3	93OXXM	68
Candelier II	C16G73	10-11	Siena	P5G73M	43
Capistrano	46XXD/M	54-55	Silhouette II	C2M72M	83
Colorado	C42GXXXL	38	Star	C28GXXM	72
Concentra	49XXXD	32-33	Starlet	C29GXXM	73
Continental	C20G624F	111	Stealth	32XXZ	62-63
Cottage	C12S72M	92	Stealth DC	C45GXXXB	64
Cottage Wet	C12DXXD	102	Tercera	C22GXXL	67
Estrada	47XXD	108	Trident	TRIH-XX	69
Four Seasons III, 52"	84UXXD	28-29	Twain	C25G624F	109
Four Seasons III, 42"	74UXXD	28-29	Utopian	77XXXD	110
Four Seasons III Gallery	84GXXD	30-31	Veneto	C15G624L	39
Four Seasons III Hugger, 52"	82UXXD	84-85	Ventura	67XXD	34-35
Four Seasons III Hugger, 42"	72UXXD	84-85	Vermont	C34G546M	82
Four Seasons III Outsider	83UXXD	105	Verrazano	65G45D	77
Heritage	C19XXXF	98-99	Vicente	C32G611L	18
Holliston	C31UXXXZ	40-41	Victorian	63XXZ	14
Holliston DC	C31UXXXB	42	Vita	C17GXXXA	70-71
Isotope, 52"	C30GXXXH/L	80-81	Wailea	41UXXD	106-107
Isotope, 44"	C35GXXXH/L	80-81	Whitman	C21GXXXH	48-49
Key Largo II	C23U73K	93	Wilderness	86U89M	95
La Fleur	PCGXXXH	94	Zephair Desk Fan	1928D	114
Lanai	79XXXD	100-101	Zephair Desk Fan	19N8D	115
Le Grande	85UXXM	74			



WHERE TO BUY

To experience The Casablanca Difference, visit an authorized Casablanca Dealer in your area and discover the abundance of style, finish, function and accessory options that have made the Casablanca name synonymous with the World's Finest Ceiling Fans™.

Our dealers' trained Casablanca specialists work with customers to select or build a product that is a seamless fit with each individual's lifestyle and environment. And Casablanca's customer support team and nationwide network of Authorized Service Centers are just a phone call away.

To find a retailer near you or shop online, call 1-800-715-0393 toll-free, or visit www.CasablancaFanCo.com.



7130 GOODLETT FARMS, SUITE 400
MEMPHIS, TN 38016
1.800.715.0393
WWW.CASABLANCAFANCO.COM

TWELVE DOLLARS
PRINTED IN THE U.S.A.
©2011 CASABLANCA FAN COMPANY

SR-1307