



FANIMATION[®] PRODUCT CATALOG 2011

F U N C T I O N . I N N O V A T I O N . Q U A L I T Y .



FUNCTION

SAVE MONEY ON ENERGY BILLS BY REDUCING ENERGY CONSUMPTION

INNOV

UNIQUE DESIGN, DIVERSE SELECTION



NOSTALGIC



TROPICAL



TRANSITIONAL

FANIM

ATION
& FORWARD THINKING TECHNOLOGY

QUALITY
INDUSTRY LEADING PRODUCT
STANDARDS & CUSTOMER SERVICE

MODERN



TRADITIONAL

ATION

RESPONSIBLE | SUSTAINABLE | EFFICIENT

WHY?

Fans provide cooling airflow desirable in warm weather and circulate warm air in cool weather. Fanimation provides these with unparalleled style

WHEN?

To conserve energy and save money, raise your thermostat in warm weather and enjoy the cool breezes from your fans. When colder weather sets in, lower your thermostat and enjoy the warm air circulation. To conserve additional energy and save even more money, only operate your fans when people or pets are present. Ceiling fans are inherently energy savings devices. Additionally, Fanimation offers a number of Energy Star qualified models for even greater energy savings

WHERE?

Any type of room can benefit from a fan. Traditionally, in the home, bedrooms, family rooms and exterior living spaces have seen the most application. More and more we are seeing larger bathrooms, walk-in closets, home offices, garages and other work spaces take advantage of fans. In the work place, lobbies, conference rooms and even cubicles will benefit from the environmental enhancement of fans. Fanimation's wide selection is able to address all environments.

Products that earn the ENERGY STAR prevent greenhouse gas emissions by meeting strict energy efficiency guidelines set by the U.S. Environmental Protection Agency and the U.S. Department of Energy



The following Fanimation fans are ENERGY STAR qualified:

- Aire Décor® (page 122)
- The Cancun™ (pages 102-105)
- The Edgewood® (pages 118-121)
- Enigma® (pages 32-33)
- The Huxley™ (pages 44-45)
- The Islander® (pages 80-83)
- The Landan™ (pages 34-35)
- The Levon™ (page 47)
- Louvre® (pages 84-87)
- The Mariano™ (page 46)
- The Multimax™ (pages 12-13)
- The Windpointe® FP7410OB fan (page 97)
- The Zonix™ Wet Location fan (page 16-17)

Ceiling fans save money year-round when turning in the proper direction

Note: Reversing blade direction is done to eliminate wind chill from the breeze generated by the fan's forward rotation during cold months. If the fan is mounted on a high ceiling, reversal is not necessary as the wind chill factor is eliminated

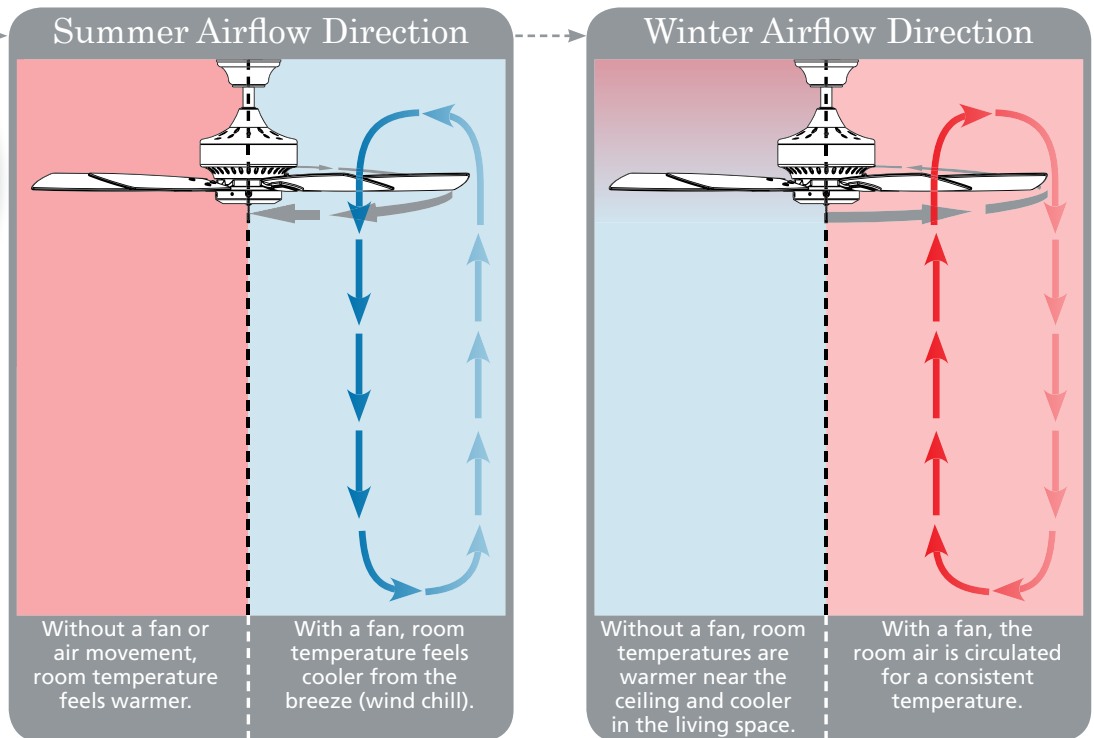

Energy Expenses (Average use—10 hours)

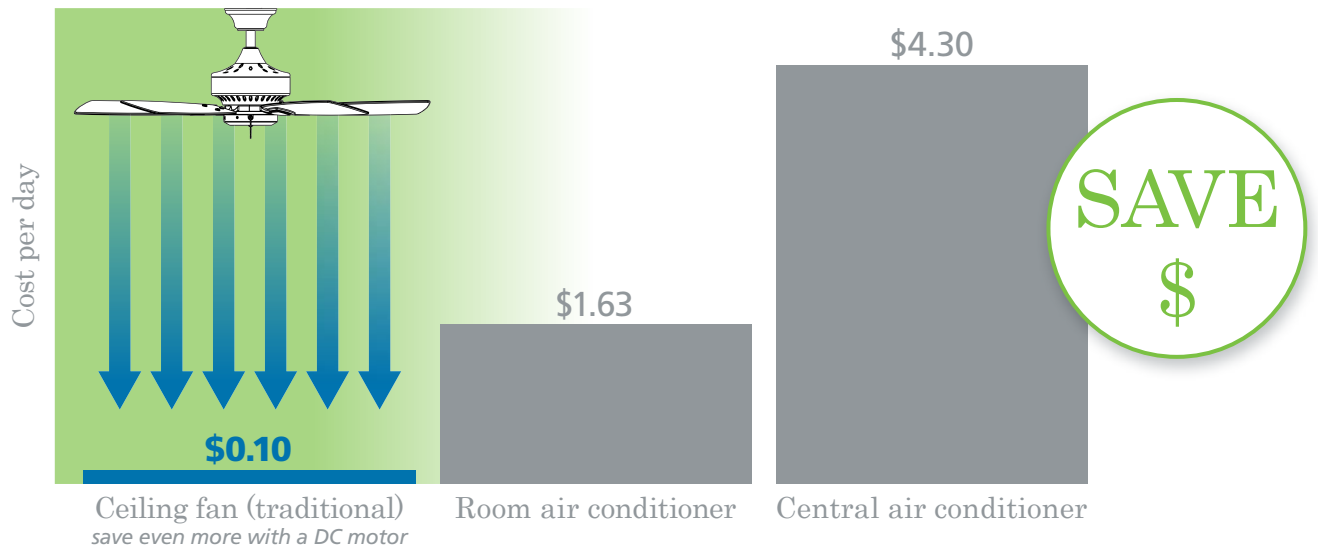

All Fanimation motors are built using high quality materials and components, insuring years of reliable and dependable operation for every Fanimation fan. As technology in motor design advances and energy efficiency becomes an important criterion for all product designs, we constantly research, develop and test these advances to assure the appropriate application. We use our motor design expertise to configure the internal motor components so that every model of fan is built using the best possible motor for its design and purpose. A hands-on approach to strict quality control levels, critical sound level requirements and strenuous motor assembly procedures are just glimpses of the intangible qualities Fanimation brings to its products. We're so confident in the quality of our motors that we offer a limited lifetime warranty on all our direct-drive motors.



NEW DC motor FACTS

Generate more power/torque than conventional ceiling fan motors while consuming less than 70% of the power.

Virtually Silent

Much smaller than conventional motors, resulting in a much lighter product

six speeds with reverse technology

Requires less electrical current by utilizing an internal array of magnets of opposing polarity. This magnetic field requires much less electrical energy to create the torque required to rotate the motor's rotor.

All electronics are centralized into one module conveniently located at the motor assembly; no canopy or switch cup manipulation is necessary.

DC motor fans: The Islander®, The Keystone™, The Landan™, Louvre®, Sandella®

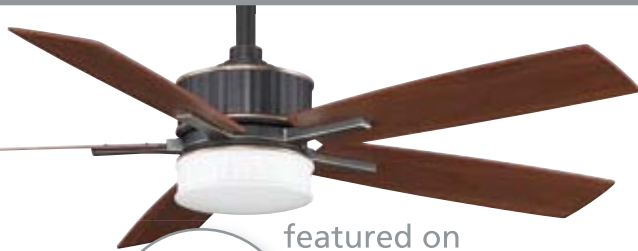

featured on The Landan™

LED LIGHTING

Only uses 25 watts to achieve a light output comparable to 140 watts of incandescent light!

- Uses an array of industry leading CREE LEDs on top of the fan to create an uplight glow and an LED cluster to create the quality light source in the lower light
- CREE LEDs have the highest lumen/watt output on the market.
- Uplight has 8 LEDs consuming only 10W of power to produce 627 Lumens (approximately equal to one 60W candelabra bulb)
- Downlight has 12 LEDs consuming only 15W of power to produce 855 Lumens (approximately equal to two 40W candelabra)
- Comparing total wattage: Incandescent candelabra = 140 Watts. Comparable LED output = 25 watts. LEDs use less than 20% of the power to produce The Landan's lumen output
- Correlated Color Temperature (CCT) is 2800 K; warm color to closely resemble a color temperature of incandescent or natural sunlight
- Color Rendering Index (CRI) is 79. CRI is the ability of a light source to light up objects of different colors and properly display the colors without influence or making the color look adjusted.
- LEDs are dimmable
- LEDs have a long lifespan of over 50,000 hours.

THROUGH THE YEARS



1973 TOM FRAMPTON (far left), A JUNIOR IN HIGH SCHOOL, BEGINS WORKING FOR BURTON A. BURTON (far right), WHO, BY 1975, FORMS THE CASABLANCA FAN COMPANY

1984 THROUGH A DEAL WITH MR. BURTON, TOM FRAMPTON LEAVES CASABLANCA WITH ITS SPECIALTY FAN DEPARTMENT AND BEGINS FANIMATION IN PASADENA, CALIFORNIA. HE STARTS THE COMPANY IN HIS GARAGE, WITH THREE UNIQUE FAN DESIGNS—THE PUNKAH®, THE PALMETTO® AND THE BOURBON STREET®

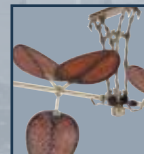
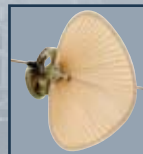

1990 THE ISLANDER® FAN IS INTRODUCED

1978

TOM FRAMPTON'S FIRST FAN DESIGN, THE PUNKAH™ – A SIDE-TO-SIDE, SYNCHRONIZED FAN – IS CREATED

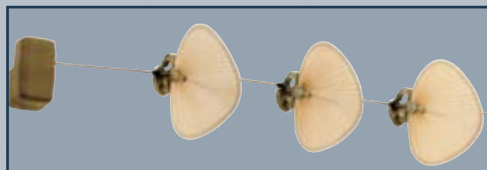

1987

THE PALISADE® FAN IS DESIGNED

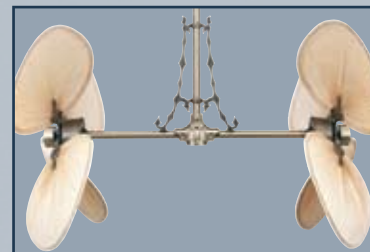



2003 FANIMATION OPENS ITS NEW CENTRALLY LOCATED CORPORATE HEADQUARTERS IN INDIANAPOLIS, INDIANA

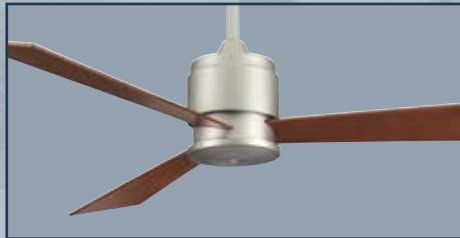

2008 THE EXTRAORDINAIRE® AND THE ZONIX™ ARE INTRODUCED

2002

ENIGMA®, FANIMATION'S FIRST MODERN FAN IS INTRODUCED

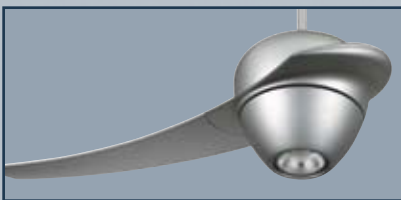

2007

NATHAN FRAMPTON BECOMES FANIMATION'S PRESIDENT, CONTINUING ITS TRADITION OF BEING A FAMILY OWNED AND RUN COMPANY



2010

FANIMATION OPENS ITS WEST COAST DISTRIBUTION CENTER TO MAXIMIZE SHIPPING EFFICIENCY

ALSO, THE MARIANO™ IS INTRODUCED AND EARNS THE ENERGY STAR



ANTIQUE FAN MUSEUM *at Fanimation*



Fanimation has a two pronged approach in bringing product into the marketplace. First are its original designs and secondly reintroducing antique fans with modern safety and control features; this approach has placed Fanimation in a league of its own, but as you might imagine, it's the antique fans that led to a museum.

Several years ago, Fanimation founder Tom Frampton, an avid antique fan collector, joined the Antique Fan Collectors Association (AFCA). The AFCA membership has operated a museum since 1997, displaying fans on loan by the membership; this museum was located outside Wichita, Kansas up until April 2008 when the need to relocate the museum arose. Answering the call to preserve viewing of the one-of-a-kind collection, Fanimation made the offer to house the museum at its facility in Zionsville. The move and set-up took some time but the museum saw its reopening July 23, 2009. The museum houses somewhere around 450 antique fans, some dating to the early 1800's. Tom's own unique collection of fans is now a part of the museum collection along with hundreds of antique advertising style hand fans and other memorabilia.

Location:
10983 Bennett Parkway
Zionsville, IN 46077
317-733-4113

Museum Hours:
Monday - Friday
10:00AM - 4:00PM
or by appointment





PASSION

HERITAGE

PRESERVATION



TABLE OF CONTENTS



P.12

THE MULTIMAX[™]
FP8008



P.14

THE ZONIX[™]
FP4620 | FP4630 | FP4640



P.18

THE INVOLUTION[™]
FP4520



P.20

THE QUATTRO[™]
FP8050



P.22

THE INLET[™]
FP57880



P.24

THE KUBIX[™]
FP4420



P.26

THE EXTRAORDINAIRE[®]
OF110



P.28

THE TORTO[™]
FP7900



P.30

THE CUMULOS[™]
FP4820



P.31

THE MAREA[™]
FP8026



P.32

ENIGMA[®]
FP2120



P.34

THE LANDAN[™]
FPD8087
LED LIGHTING **DC motor**
CONSUMES UP TO 70% LESS ENERGY



P.36

THE KEISTONE[™]
FPD8088 | FPD8089
DC motor
CONSUMES UP TO 70% LESS ENERGY



P.38

THE BENITO[™]
FP8003



P.40

THE AKIRA[™]
FP8000

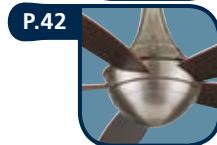

P.42

THE CELANO[™]
FP5420



P.44

THE HUXLEY[™]
FP5620



P.46

THE MARIANO[™]
FP7930



P.47

THE LEVON[™]
FP7910



P.48

THE AIR SHADOW[™]
FP810 | FP815 | FP820 | FP825

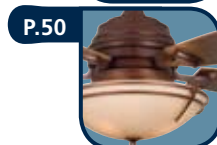

P.50

THE HUBBARDTON FORGE[®]
HF6050 | HF6200 | HF6600 | HF7200 | HF7240 | HF7600



P.54

THE ANDOVER[™]
FP5220

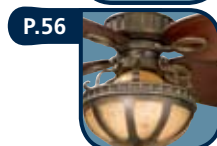

P.56

THE BAYHILL COLLECTION[™]
LB250 | LB270
by Lauren Brooks

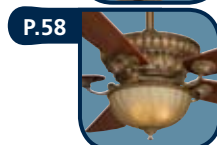

P.58

THE VENTANA[™]
FP8032



P.60

THE AMERICANA[®]
FP410 | FP420

P.62  **THE BOURBON STREET®**
FP510 | FP520 | FP580

P.64  **THE BREWMASTER®**
FP1280 | FP10 | FP20

P.66  **FARGO®**
FP3320

P.67  **THE FITZGERALD®**
OF6320

P.68  **THE ARDEN™**
FP8014

P.70  **THE OLD HAVANA®**
FPH210

P.74  **THE LORETO BAY™**
FPS7840

P.76  **SANDELLA®**
MAD3260 **DC motor**
CONSUMES UP TO 70% LESS ENERGY

P.80  **THE ISLANDER®**
MAD3250 **DC motor**
CONSUMES UP TO 70% LESS ENERGY

P.84  **LOUVRE®**
MAD3255 **DC motor**
CONSUMES UP TO 70% LESS ENERGY

P.88  **THE BELLERIA®**
FP4320

P.92  **THE TORRENTO®**
FP920

P.94  **THE WINDPOINTE®** (UNPACKED)
FP7300 | FP7410 | FP7500 | FP7510

P.98  **THE WINDPOINTE®** (CUSTOM)
MA7500

P.102  **THE CANCUN™**
FP8009 | FP8011 | FP8012 | FP8016 | FP8042

P.106  **THE PALISADE®**
FP240

P.110  **THE CARUSO™**
FP7000

P.114  **THE PALMETTO®**
FP601 (602, 603, 604, 605)

P.116  **THE PUNKAH®**
FP780

P.118  **THE EDGEWOOD®**
TF610 | TF710 | TF721 | TF910 | TF971

P.122  **AIRE DÉCOR®**
BP200 | BP210 | BP215 | BP220 | BP225 | BP230

P.124  **LIGHT KITS**

P.126  **FITTERS, SHADES &
DECORATIVE GLASS**

P.128  **CONTROLS**

P.132  **DOWNRODS
& ACCESSORIES**

P.134  **BLADES**

NEW FOR 2011

THE LANDAN™ | P. 34



DC motor
CONSUMES UP TO 70% LESS ENERGY



LED LIGHTING

THE KEISTONE™ | P. 36
60" AND 72" FANS

DC motor
CONSUMES UP TO 70% LESS ENERGY



THE ARDEN™ | P. 68

THE MAREA™ | P. 31



THE CANCUN™ | P. 104
42" FAN



THE CANCUN™ | P. 105
WET LOCATION FAN

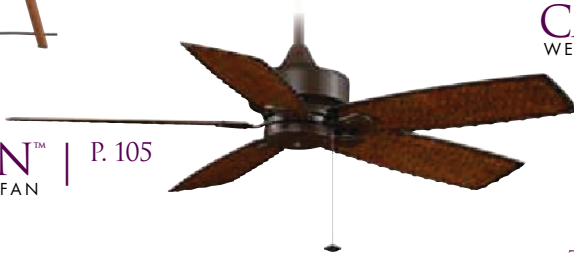

THE CANCUN™ | P. 105
WET LOCATION FAN

THE ZONIX™ | P. 16
WET LOCATION FAN



THE ISLANDER® | P. 80
REDESIGN

DC motor
CONSUMES UP TO 70% LESS ENERGY

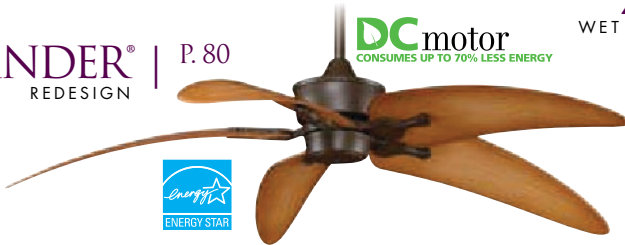

SANDELLA® | P. 76
REDESIGN

DC motor
CONSUMES UP TO 70% LESS ENERGY



LOUVRE® | P. 84
REDESIGN

DC motor
CONSUMES UP TO 70% LESS ENERGY



THE EDGEWOOD™ | P. 118
REDESIGN



THE WINDPOINTE™ | P. 94
TWO NEW UNIPACKS

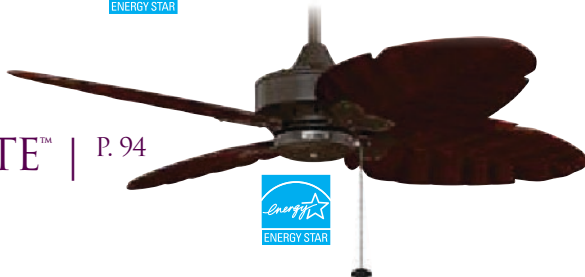

FAN INDEX

The Air Shadow™ - FP810 FP815 FP820 FP825	48-49
Aire Décor® - BP200 BP210 BP215 BP220 BP225 BP230	2, 122-123
The Akira™ - FP8000	40-41
The Americana® - FP410 FP420	60-61
The Andover™ - FP5220	54-55
The Arden™ FP8014	10, 68-69
The Bayhill Collection™ by Lauren Brooks® - LB250VZ LB270VZ	56-57
The Belleria® - FP4320	88-91
The Benito™ - FP8003	38-39
The Bourbon Street® - FP510 FP520	4, 62-63
The Brewmaster® - FP10 FP20	64-65
The Cancun™ - FP8009 FP8011 FP8012 FP8016 FP8042	2, 10, 102-105, 133
The Caruso® - FP7000	110-113
The Celano™ - FP5420	42-43
The Cumulos™ - FP4820	30
The Edgewood® - FP610 FP710 FP721 FP910 FP971	2, 10, 118-123
Enigma® - FP2120	2, 5, 32-33
The Extraordinaire® - OF110	5, 26-27
Fargo® - FP3320	66
The Fitzgerald® - OF6320	7, 67
Hubbardton Forge® - HF6050 HF6200 HF6600 HF7200 HF7240 HF7600	50-53
The Huxley™ - FP5620	2, 44-45
The Inlet™ - FPS7880	22-23
The Involution™ - FP4520	18-19
The Islander® - MAD3250	2, 4, 80-83, 134, 137
The Keystone™ FPD8088 FPD8089	10, 36-37
The Kubix™ - FP4420	24-25
The Landan™ FPD8087	2, 10, 34-35
The Levon™ - FP7910	2, 47
The Loreto Bay™ - FPS7840	74-75
Louvre® - MAD3255	2, 10, 84-87, 135
The Marea™ FP8026	10, 31
The Mariano™ - FP7930	2, 5, 46
The Multimax™ - FP8008	2, 12-13
The Old Havana® - FP210	70-71
The Palisade® - FP240	106-109, 133
The Palmetto® - FP601	4, 114-115
The Punkah® - FP720	4, 116-117
The Quattro™ - FP8050	20-21
Sandella® - MAD3260	10, 76-79
The Torrento® - FP920	92-93
The Torto™ - FP7900	28-29
The Ventana™ - FP8032	58-59
The Windpointe® - FP7300 FP7410 FP7500 FP7510 MA7500	2, 10, 94-97
The Zonix™ - FP4620 FP4630 FP4640	2, 5, 10, 14-17

ICON KEY



= fan has earned the ENERGY STAR



= fan is powered by an energy efficient DC motor



= for use in dry locations ONLY



= for use in dry or damp locations



= for use in dry, damp or wet locations



= all fans in the family are available in 220V versions



= lighting options are available



= control options are available



= blade options are available



= select finishes in the family are available in 220V versions



FAN: FP8008CH (1)
chrome assembly with cap (included) and reversible cherry/mahogany blades

- 2-blade configuration, mahogany side showing

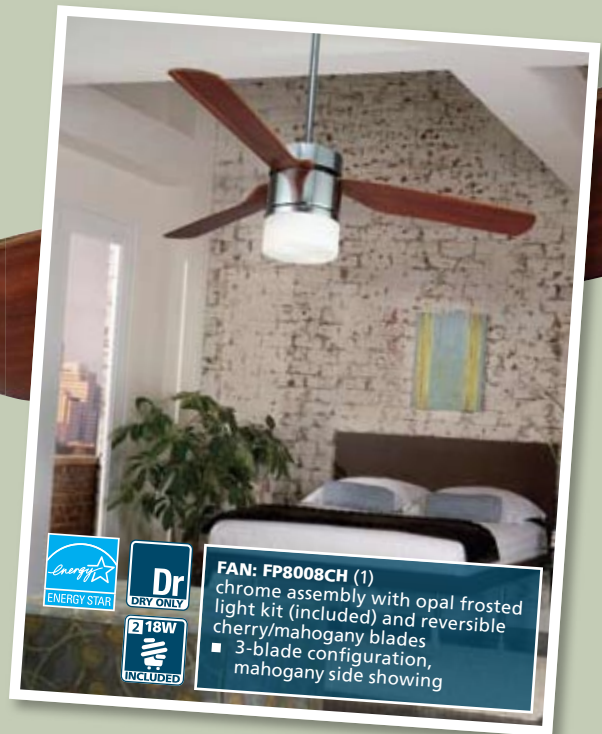

FAN: FP8008CH (1)
chrome assembly with opal frosted light kit (included) and reversible cherry/mahogany blades

- 3-blade configuration, mahogany side showing



FAN: FP8008CH (1)
chrome assembly with opal frosted light kit (included) and reversible cherry/mahogany blades

- 4-blade configuration, cherry side showing

THE MULTIMAX™



ONE VERSATILE FAN—SIX LIGHTING AND BLADE CONFIGURATIONS

ENERGY INFORMATION

at High Speed

Airflow	Electricity Use	Airflow Efficiency
5797	56	103
Cubic Feet Per Minute	Watts (excluding lights)	Cubic Feet Per Minute Per Watt

UNIPACKED
CONTROL & BLADES INCLUDED

LIMITED LIFETIME MOTOR WARRANTY

BUILT-IN DOWNLIGHT

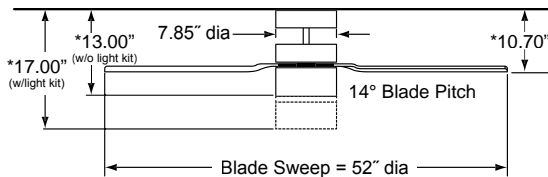

*With included 6" downrod

Finishes (swatches on page 132):

CH fan | CY/MH reversible blade

Blades:

23" blade set included (see finish above)
—fan can be assembled in 2-, 3- or 4-blade configuration with ease

Motor:

172 x 18

Speeds:

3 forward and 3 reverse (reversing switch on motor housing)

Controls:

CRL8TS touch screen hand-held remote control included.
Optional controls available (p.128-131)

Lighting:

Includes opal frosted glass light kit with two 18-watt low profile CFL bulbs and cap for use without light kit

Downrod:

½" dia. x 6" long downrod included
Longer lengths available—p.132

Ceiling slope

Up to 30°

Location Use:

Dry location rated only

Net Hanging Weight:

20.5 lbs.

ETL LISTED

OPTIONS



THE MULTIMAX™



FAN: FP8008CH (1)

chrome assembly with opal frosted light kit (included) and reversible cherry/mahogany blades

- 3-blade configuration, mahogany side showing



DOWNRODS:

Length	Part No.
12"	DR12CH
18"	DR18CH
24"	DR24CH
36"	DR36CH
48"	DR48CH
60"	DR60CH
72"	DR72CH

For longer lengths, join two downrods with DRPCPH



TOUCH-SCREEN REMOTE INCLUDED:

CRL8TS

- Fan and light remote control
- 3 speed
- Learn-mode receiver
- Touch-screen operation
- 1-12 hour fan shut-off timer
- 3-minute delay light on/off





Da
DAMP

FAN: FP4620SN (1)
satin nickel assembly
BLADE SET: BPW4442WA (1)
20" all-weather composite
walnut (sold separately)



Dr
DRY ONLY

FAN: FP4620OB (1)
oil-rubbed bronze assembly with 26"
reversible cherry/walnut wood blades
■ cherry side showing
HOUSING ACCESSORY: HA4620CY (1)
cherry woven housing accessory
(sold separately)

Dr
DRY ONLY

**OPTIONAL
HOUSING
ACCESSORY:**



HA4620CY
Cherry woven
housing accessory



HA4620WA
Walnut woven
housing accessory



Dr
DRY ONLY

FAN: FP4620PN (1)
polished nickel assembly with 26"
reversible cherry/walnut wood blades
■ cherry side showing

LIGHT KIT: LK4620PN (1)
polished nickel with opal frosted glass
(sold separately)

13W
INCLUDED

THE ZONIX™

MODERN SOPHISTICATION—DRY AND DAMP LOCATION FAN

ENERGY INFORMATION

at High Speed

Airflow	Electricity Use	Airflow Efficiency
4260 Cubic Feet Per Minute	57 Watts (excluding lights)	75 Cubic Feet Per Minute Per Watt

UNPACKED
CONTROL & BLADES INCLUDED

LIMITED LIFETIME MOTOR WARRANTY

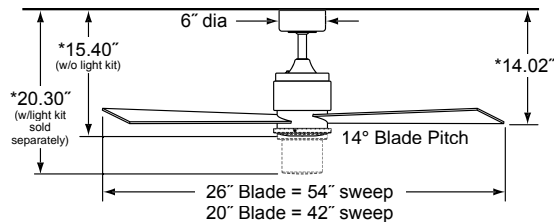

*With included 6" downrod

Finishes (swatches on page 132):

OB fan | CY/WA reversible blade
 PN fan | CY/WA reversible blade
 SN fan | CY/WA reversible blade
 SN fan | SN blade
 (Wet location finishes on next page)

Blades:

26" blade set included (see finish above)
 Optional blades available (see below)

Motor:

153 x 18

Speeds:

4 forward and 4 reverse (reversing switch on motor housing)

Controls:

Includes CW40 fan-only wall control.
 Optional controls available (p.128-131)

Lighting:

Optional 13-watt CFL fan specific kit available—sold separately (below)
 Also accepts standard fitters and light kits—sold separately (pages 124-127)

Downrod:

1" dia. x 6" long downrod included
 Longer lengths available—p.132
 Close-to-ceiling kit available—p.133

Ceiling slope

Up to 30° (52° with SCB1-52)

Location Use:

Dry location rated only
 Damp location rated with use of BPW series blades
 (Wet location fans on next page)

Net Hanging Weight:

19.8 lbs.

UL LISTED

OPTIONS





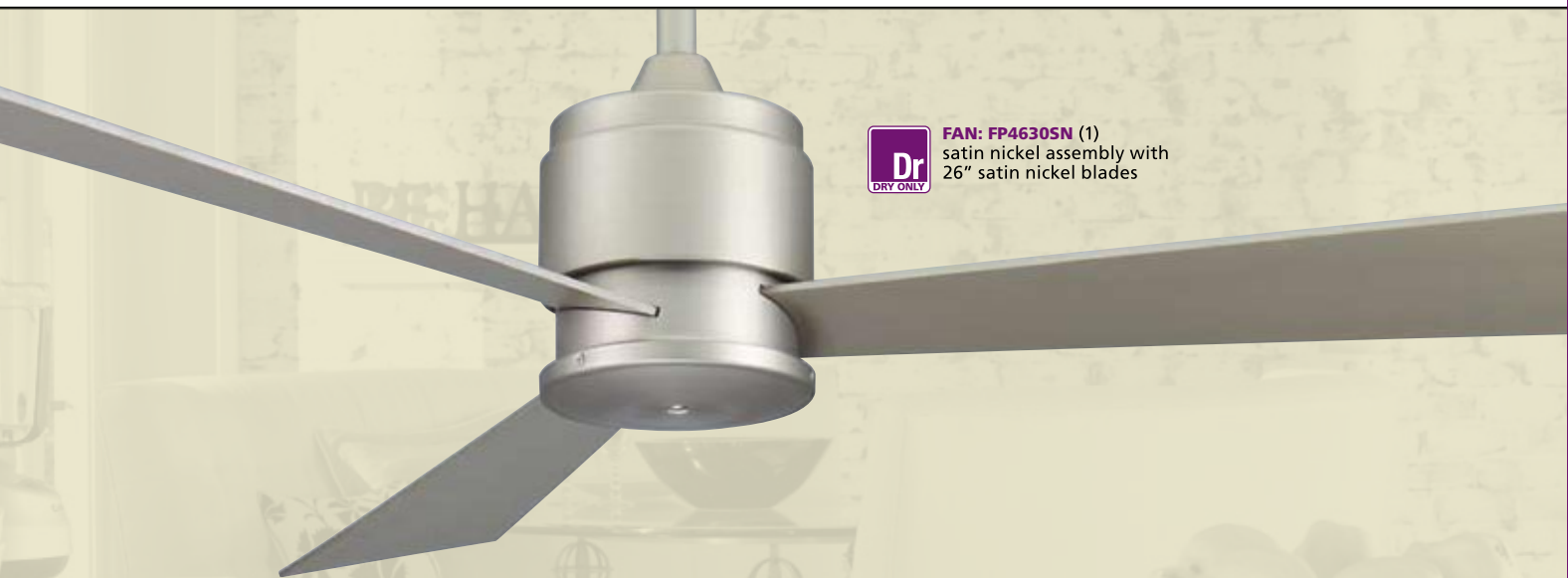

THE ZONIX™ — DRY & DAMP LOCATION FAN

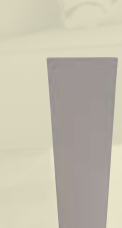

FAN: FP4630SN (1)
 satin nickel assembly with
 26" satin nickel blades

OPTIONAL BLADES:

				
Dr DRY ONLY	Dr DRY ONLY	Dr DRY ONLY	Da DAMP	Da DAMP
B4400SN 26" satin nickel	B4442SN 20" satin nickel	B4442CWR 20" reversible cherry/walnut	BPW4442CY 20" cherry all-weather composite	BPW4442WA 20" walnut all-weather composite



OPTIONAL LIGHT KIT:



LK4620**

- Opal frosted glass
- 13-watt CFL bulb included
- Non-dimming
- Fan supplied with fan-only control—additional switch or remote control required (see pages 128-131)



WALL CONTROL INCLUDED:



CW40

- Wall control with face plate included
- Fan-only control
- 4 fan speeds



FAN: FP4640OB (1)
oil-rubbed bronze assembly with 25"
cherry all-weather composite blades



FAN: FP4640OB (1)
oil-rubbed bronze assembly
with 25" cherry all-weather
composite blades



FAN: FP4640WH (1)
white assembly with 25" white all-
weather composite blades

THE ZONIX™

MODERN SOPHISTICATION FOR WET LOCATIONS



ENERGY INFORMATION

at High Speed

Airflow	Electricity Use	Airflow Efficiency
5077 Cubic Feet Per Minute	53 Watts (excluding lights)	96 Cubic Feet Per Minute Per Watt

UNIPACKED
CONTROL & BLADES INCLUDED

LIMITED LIFETIME MOTOR WARRANTY

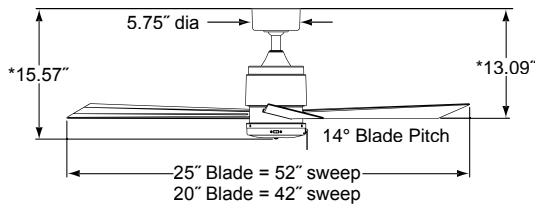

*With included 6" downrod

Finishes (swatches on page 132):

OB fan | CY blade
SN fan | SN blade
WH fan | WH blade

Blades:

25" all-weather composite blade set included (see finish above)
Optional blades available (see below)

Motor:

153 x 18

Speeds:

3 forward and 3 reverse (reversing switch on switch cup housing)

Controls:

Optional controls available (pages 128-131)

Lighting:

Accepts standard fitters and light kits—sold separately (pages 124-127)

Downrod:

1" dia. x 6" long downrod included
Longer lengths available—page 132

Ceiling slope

Up to 30° (52° with SCB1-52)

Location Use:

Dry, damp and wet location rated (housing and switch cup are made of all-weather composite materials instead of steel)

Net Hanging Weight:

14.7 lbs.

UL LISTED

OPTIONS

P 124-127



P 128-131



SEE BELOW



Da DAMP



We WET



THE ZONIX™ — WET LOCATION FAN



FAN: FP4640SN (1)
satin nickel assembly with 25" satin nickel all-weather composite blades

OPTIONAL BLADES:



BPW4442CY
20" cherry all-weather composite



BPW4442WA
20" walnut all-weather composite



FAN: FP4520OB (1)
oil-rubbed bronze assembly with reversible cherry/walnut wood blades
■ walnut side showing



LIGHT KIT: LK4520OB (1)
oil-rubbed bronze with opal frosted glass (sold separately)



FAN: FP4520SN (1)
satin nickel assembly
BLADE SET: B4500SN (1)
25" satin nickel blades (sold separately)

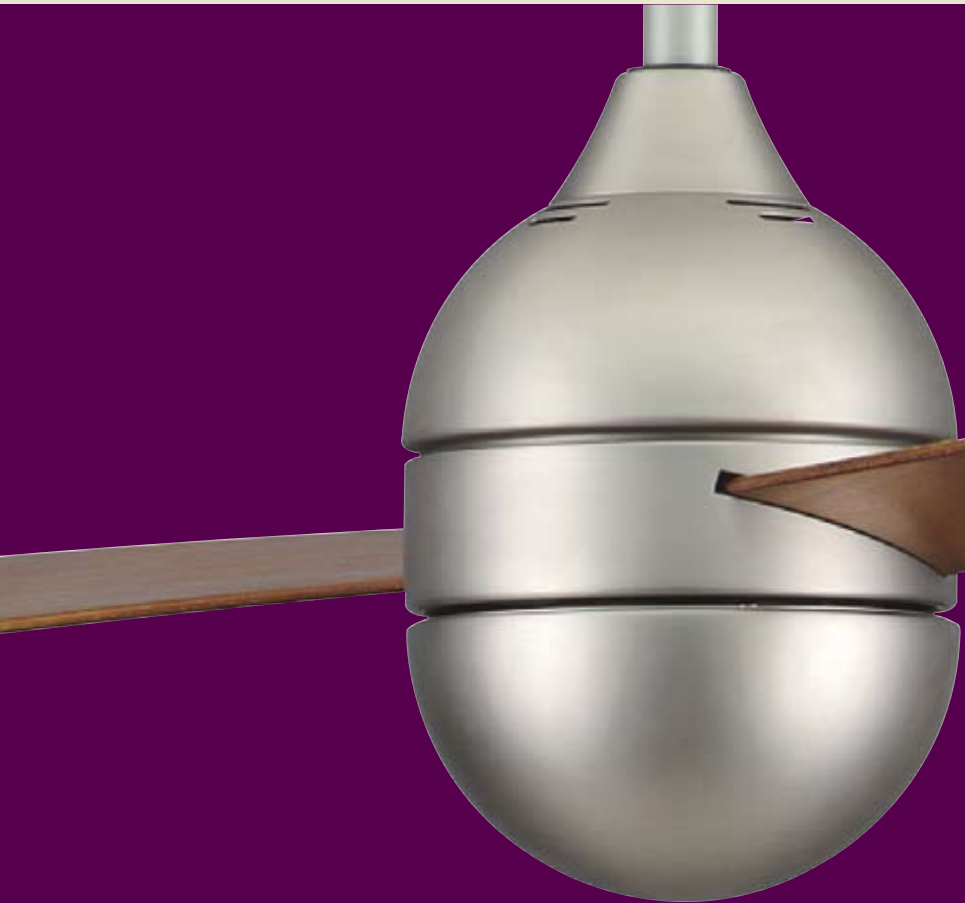

FAN: FP4520SN (1)
satin nickel assembly
BLADE SET: BPW4542CY (1)
20" all-weather composite cherry blades (sold separately)

THE INVOLUTION™

THE ART OF ILLUSION

ENERGY INFORMATION

at High Speed

Airflow	Electricity Use	Airflow Efficiency
4207 Cubic Feet Per Minute	49 Watts (excluding lights)	86 Cubic Feet Per Minute Per Watt

UNPACKED
CONTROL & BLADES INCLUDED

LIMITED LIFETIME MOTOR WARRANTY

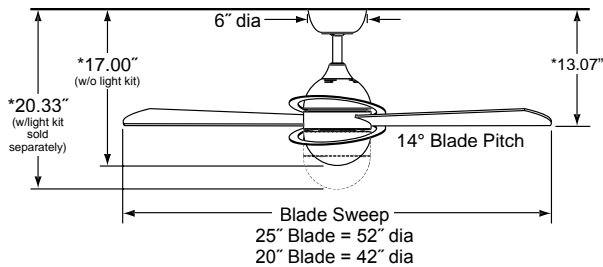

*With included 6" downrod

Finishes (swatches on page 132):

OB fan	CY/WA reversible blade
PN fan	CY/WA reversible blade
SN fan	CY/WA reversible blade
SN fan	SN blade

Decorative Rings:

Rings matching fan finish are included but optional—not required to operate

Blades:

25" blade set included (see finish above)
Optional blades available (below)

Motor:

153 x 18

Speeds:

4 forward and 4 reverse (reversing switch on motor housing)

Controls:

Includes CW40 fan-only wall control.
Optional controls available (p.128-131)

Lighting:

Optional 75-watt E11 halogen minican fan specific kit available—sold separately (below)

Downrod:

1" dia. x 6" long downrod included
Longer lengths available—p.132
Close-to-ceiling kit available—p.133

Location Use:

Dry location rated only
Damp location rated with use of BPW series blades

Ceiling slope

Up to 30° (52° with SCB1-52)

Net Hanging Weight:

19.8 lbs.

UL LISTED

OPTIONS



THE INVOLUTION™



FAN: FP4520OB (1)
oil-rubbed bronze assembly with reversible cherry/walnut blades
■ cherry side showing

OPTIONAL BLADES:



B4500SN
25" satin nickel



B4542SN
20" satin nickel



B4542CWR
20" reversible cherry/walnut



BPW4542CY
20" cherry all-weather composite



BPW4542WA
20" walnut all-weather composite



OPTIONAL LIGHT KIT:

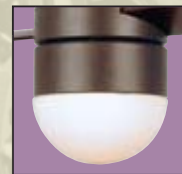

LK4520**

- Opal frosted glass
- 75-watt E11 halogen minican bulb included
- Fan supplied with fan-only control—additional switch or remote control required (see pages 128-131)



WALL CONTROL INCLUDED:



CW40

- Wall control with face plate included
- Fan-only control
- 4 fan speeds



FAN: FP8050SN (1)
satin nickel assembly fan with
halogen light and reversible
cherry/satin nickel blades
■ satin nickel side showing



FAN: FP8050SN (1)
satin nickel assembly fan with
halogen light and reversible
cherry/satin nickel blades
■ satin nickel side showing

THE QUATTRO™

SLEEK STYLING—WHY NOT GIVE IT A WHIRL?

ENERGY INFORMATION

at High Speed

Airflow	Electricity Use	Airflow Efficiency
4295 Cubic Feet Per Minute	46 Watts (excluding lights)	93 Cubic Feet Per Minute Per Watt

UNIPACKED
CONTROL & BLADES INCLUDED

LIMITED LIFETIME MOTOR WARRANTY

BUILT-IN DOWNLIGHT

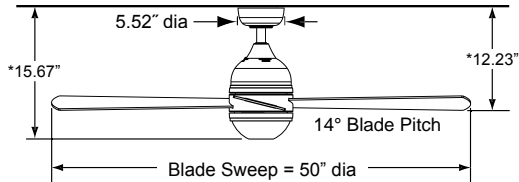

*With included 4.5" downrod

Finishes (swatches on page 132):
SN fan | CY/SN reversible blade

Blades:
25" blade set included (see finish above)

Motor:
153 x 18

Speeds:
3 forward and 3 reverse (reversing switch on motor housing)

Controls:
TR24WH hand-held remote with wall mount
Optional controls available (p.128-131)

Lighting:
One 50-watt GU10/MR16 halogen bulb included

Downrod:
1" dia. x 4.5" long downrod included
Longer lengths available—p.132
Close-to-ceiling kit available—p.133

Location Use:
Dry location rated only

Ceiling slope:
Up to 30°

Net Hanging Weight:
15.9 lbs.

UL LISTED

OPTIONS



THE QUATTRO™



REMOTE & WALL MOUNT INCLUDED:



TR24WH

- Fan and light control
- Mounts over switch plate
- 3 speed non-reversing
- Infinite light levels



FAN: FP8050SN (1)
satin nickel assembly fan with halogen light and reversible cherry/satin nickel blades
■ cherry side showing



Dr
DRY ONLY

18W
INCLUDED

FAN: FPS7880SN (1)
satin nickel assembly with opal frosted glass and reversible cherry/walnut wood blades
■ cherry side showing



Dr
DRY ONLY

18W
INCLUDED

FAN: FPS7880OB (1)
oil-rubbed bronze assembly with opal frosted glass and reversible cherry/walnut wood blades
■ cherry side showing

HOUSING ACCESSORY: HA7880CY (1)
cherry woven housing accessory (sold separately)



Dr
DRY ONLY

18W
INCLUDED

FAN: FPS7880SN (1)
satin nickel assembly with opal frosted glass and reversible cherry/walnut wood blades
■ walnut side showing

HOUSING ACCESSORY: HA7880WA (1)
walnut woven housing accessory (sold separately)

Da
DAMP

18W
INCLUDED

FAN: FPS7880OB (1)
oil-rubbed bronze assembly with opal frosted glass cherry side showing

BLADE SET: BPW7880WA (1)
18" all-weather composite walnut blades (sold separately)



Dr
DRY ONLY

18W
INCLUDED

FAN: FPS7880SN (1)
satin nickel assembly with opal frosted glass

BLADE SET: B7880SN (1)
23" satin nickel blade (sold separately)

THE INLET™

COOL LINES, COOL BREEZES

SNUGGER FAN

MOUNTS FLUSH TO CEILING

ENERGY INFORMATION

at High Speed

Airflow	Electricity Use	Airflow Efficiency
5102 Cubic Feet Per Minute	59 Watts (excluding lights)	86 Cubic Feet Per Minute Per Watt

UNIPACKED
CONTROL & BLADES INCLUDED

LIMITED LIFETIME MOTOR WARRANTY

BUILT-IN DOWNLIGHT

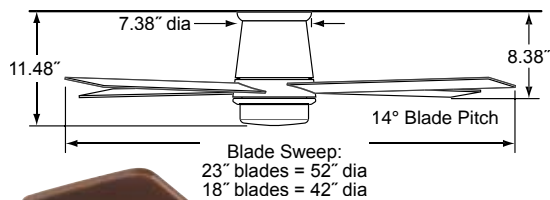

Finishes (swatches on page 132):

OB fan | CY/WA reversible blade
SN fan | CY/WA reversible blade

Blades:

23" blade set included (see finish above)
Optional blades available (below)

Motor:

172 x 14

Speeds:

3 forward and 3 reverse (reversing switch on remote)

Controls:

TR20WH hand-held remote with wall mount
Optional controls available (p.128-131)

Lighting:

Opal frosted glass light with one 18-watt
GU24 CFL bulb included

Downrod:

Fan mounts flush to ceiling and does not require use of a downrod

Location Use:

Dry location rated only
Damp location rated when used with BPW7880CY, BPW7880SN or BPW7880WA blade sets (sold separately)

Net Hanging Weight:

19.2 lbs.

UL LISTED

OPTIONS

128-131

CONTROLS

SEE BELOW

BLADES

Da
DAMP

THE INLET™



Dr
DRY ONLY

FAN: FPS7880SN (1)
satin nickel assembly with opal frosted glass and reversible cherry/walnut wood blades
■ walnut side showing

1 18W
INCLUDED

OPTIONAL BLADES:



Dr
DRY ONLY

B7880SN
23" satin nickel

Da
DAMP

BPW7880CY
18" cherry all-weather composite

Da
DAMP

BPW7880WA
18" walnut all-weather composite

Da
DAMP

BPW7880SN
18" satin nickel all-weather composite

Dr
DRY ONLY

OPTIONAL WOVEN HOUSING ACCESSORIES:



HA7880CY
Cherry woven housing accessory



HA7880WA
Walnut woven housing accessory

Dr
DRY ONLY

REMOTE & WALL MOUNT INCLUDED:



TR20WH

- Fan and light control
- Mounts over switch plate
- 3 speed reversing
- Infinite light levels



FAN: FP44200B (1)
oil-rubbed bronze assembly with opal frosted glass



BLADE SET: BPW4442CY (1)
20" all-weather composite cherry blades
(sold separately)



FAN: FP4420SN (1)
satin nickel assembly with opal
frosted glass and reversible
cherry/walnut wood blades
■ walnut side showing



FAN: FP4420SN (1)
satin nickel assembly with opal
frosted glass



BLADE SET: B4400SN (1)
26" satin nickel blades
(sold separately)

THE KUBIX™

THINK OUTSIDE THE BOX - THINK IN THE CUBE

ENERGY INFORMATION

at High Speed

Airflow 4565 Cubic Feet Per Minute	Electricity Use 55 Watts (excluding lights)	Airflow Efficiency 83 Cubic Feet Per Minute Per Watt
---	---	---

UNIPACKED
CONTROL & BLADES INCLUDED

LIMITED LIFETIME MOTOR WARRANTY

BUILT-IN DOWNLIGHT

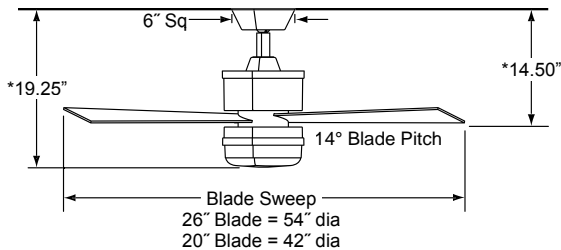

*With included 6" downrod

Finishes (swatches on page 132):

OB fan | CY/WA reversible blade | opal glass
SN fan | CY/WA reversible blade | opal glass

Blades:

26" blade set included (see finish above)
Optional blades available (below)

Motor:

153 x 18

Speeds:

3 forward and 3 reverse (reversing switch on housing)

Controls:

TR24WH hand-held remote with wall mount
Optional controls available (p.128-131)

Lighting:

Two 60-watt candelabra bulbs included

Downrod:

Downrod with square sleeve included—1" dia. x 6" long downrod included.
Longer length downrod and sleeves available—see below
Close-to-ceiling kit available—p.133

Ceiling slope

Up to 30° (52° with SCB1-52)

Location Use:

Dry location rated only
Damp location rated with use of BPW series blades

Net Hanging Weight:

19.5 lbs.

UL LISTED

OPTIONS



THE KUBIX™



FAN: FP4420SN (1)
satin nickel assembly with opal frosted glass and reversible cherry/walnut wood blades



■ cherry side showing

OPTIONAL BLADES:

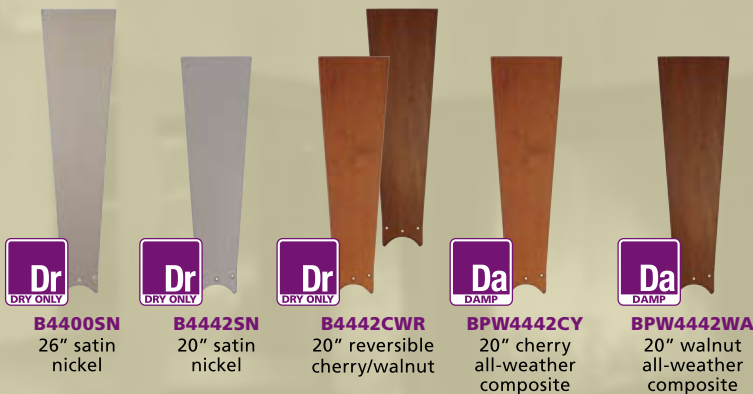

SQUARE DOWNRODS



Length	Part No.	Part No.
12"	DRSQ120B	DRSQ125N
18"	DRSQ180B	DRSQ185N
24"	DRSQ240B	DRSQ245N
36"	DRSQ360B	DRSQ365N
48"	DRSQ480B	DRSQ485N
60"	DRSQ600B	DRSQ605N
72"	DRSQ720B	DRSQ725N

Includes round downrod and square sleeve



REMOTE & WALL MOUNT INCLUDED:



TR24WH

- Fan and light control
- Mounts over switch plate
- 3 speed non-reversing
- Infinite light levels



FAN: OF110PW (1)
pewter assembly
with black cage



FAN: OF1100B (1)
oil-rubbed bronze assembly
with black cage



FAN: OF110SN (1)
satin nickel assembly
with black cage

THE EXTRAORDINAIRE®

BEYOND ORDINARY

UNPACKED
CONTROLS INCLUDED

LIMITED LIFETIME MOTOR WARRANTY

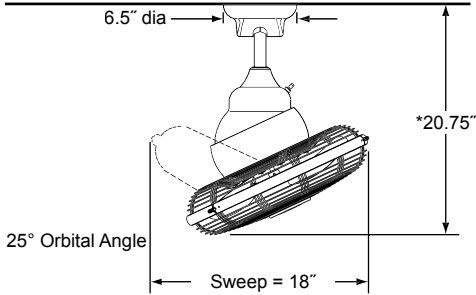

*With included 6" downrod

Finishes (swatches on page 132):

PW fan | black cage
OB fan | black cage
SN fan | black cage

Blades:
16" blades

Motor:
82 x 25

Speeds:
3 forward (non-reversing)

Orbital motion:
Continuous when fan is running

Controls:
Includes CW110WH wall control
Optional RC110WH remote available (p.128-131)

Downrod:

1" dia. x 6" long downrod included
Longer lengths available—p.132
Close-to-ceiling kit available—p.133

Ceiling slope:
Up to 50°

Location Use:
PW dry location rated only
OB and SN dry and damp location rated

Net Hanging Weight:
14.5 lbs.

UL LISTED

OPTIONS



THE EXTRAORDINAIRE®



FAN: OF110SN (1)
satin nickel assembly
with black cage



WALL CONTROL INCLUDED:



CW110WH

- Fan-only control
- face plate included
- 3 speed non-reversing



FAN: OF110PW (1)
pewter assembly
with black cage



FAN: FP7900OB (1)
oil-rubbed bronze assembly
with opal frosted glass



FAN: FP7900MG (1)
metro gray assembly
with opal frosted glass



THE TORTO™

A NEW TWIST TO AN OLD FRIEND

ENERGY INFORMATION at High Speed

Airflow 4400 Cubic Feet Per Minute	Electricity Use 58 Watts (excluding lights)	Airflow Efficiency 76 Cubic Feet Per Minute Per Watt
---	---	---

UNIPACKED
CONTROL & BLADES INCLUDED

LIMITED LIFETIME MOTOR WARRANTY

BUILT-IN DOWNLIGHT

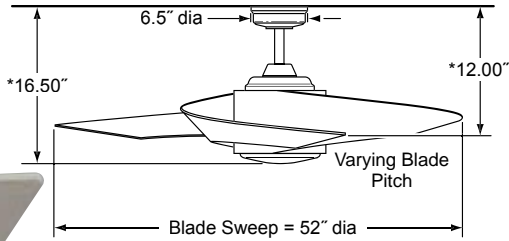

*With included 6" downrod

Finishes (swatches on page 132):

MG fan
OB fan

Blades:
composite blade set Included

Motor:
172 x 20

Speeds:
3 forward and 3 reverse (reversing switch on remote)

Controls:
TR20WH hand-held remote with wall mount
Optional controls available (p.128-131)

Lighting:
Two 60-watt candelabra bulbs included

Downrod:

1" dia. x 6" long downrod included
Longer lengths available—p.132
Close-to-ceiling kit available—p.133

Ceiling slope
Up to 30°

Location Use:
Dry and damp location rated

Net Hanging Weight:
27.4 lbs.

UL LISTED

OPTIONS

128-131
CONTROLS

Da
DAMP

THE TORTO™

NOTE: Airflow moves outward at an angle instead of directly downward

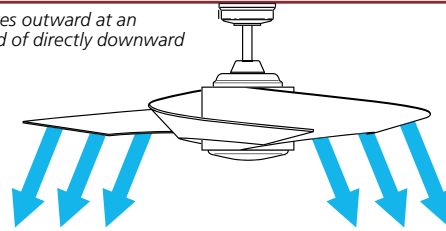

Da
DAMP

FAN: FP7900MG (1)
metro gray assembly
with opal frosted glass

2 60W
INCLUDED

Dr
DRY ONLY

REMOTE & WALL MOUNT INCLUDED:

TR20WH

- Fan and light control
- Mounts over switch plate
- 3 speed reversing
- Infinite light levels



THE CUMULOS™

ON CLOUD NINE

UNPACKED
CONTROLS INCLUDED

LIMITED LIFETIME MOTOR WARRANTY

BUILT-IN DOWNLIGHT

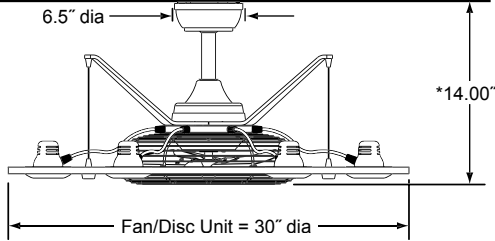

Finishes (swatches on page 132):

White frosted acrylic base with pewter cage and accent pieces

Blades:
12" fan

Motor:
90 x 25

Speeds:
3 forward (non-reversing)

Controls:
TR24WH hand-held remote with wall mount
Optional controls available (p.128-131)

Lighting:
Six 25-watt MR16 120v GU10 bulbs included

Downrod:

1" dia. x 6" long downrod included
Longer lengths available—p.132

Ceiling slope:
Up to 30°

Location Use:
Dry location rated only

Net Hanging Weight:
23.8 lbs.

Patents pending

UL LISTED

OPTIONS

128-131
CONTROLS

Dr
DRY ONLY

*With included 6" downrod



FAN: FP4820PW (1)
white frosted base
with pewter cage and
accent pieces



REMOTE & WALL MOUNT INCLUDED:

TR24WH

- Fan and light control
- Mounts over switch plate
- 3 speed non-reversing
- Infinite light levels



THE MAREA™

THE WAVE OF THE FUTURE

ENERGY INFORMATION

at High Speed

Airflow	Electricity Use	Airflow Efficiency
3151 Cubic Feet Per Minute	47 Watts (excluding lights)	67 Cubic Feet Per Minute Per Watt

UNIPACKED
CONTROL & BLADES INCLUDED

LIMITED LIFETIME MOTOR WARRANTY

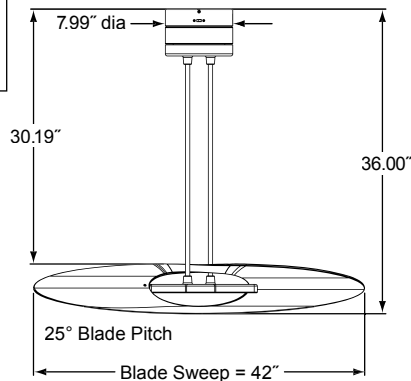
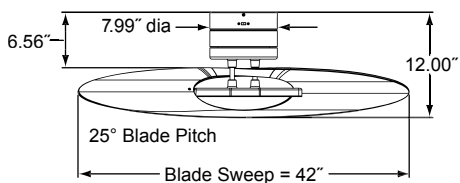

Finishes (swatches on page 132):

OB fan
SN fan

Blades:

Blade Included

Motor:

153 x 25

Speeds:

3 forward and 3 reverse (reversing switch on housing)

Controls:

TR33 hand-held remote with wall mount

Downrod:

2 sets of double downrods included

Ceiling slope

None

Location Use:

Dry location rated only

Net Hanging Weight:

25.13 lbs.

UL LISTED

OPTIONS



FAN: FP8026OB (1)
oil-rubbed bronze fan
with amber frosted blade



REMOTE &
WALL MOUNT
INCLUDED:



TR33

- Fan control
- Mounts over switch plate
- 3 speed non-reversing



FAN: FP8026SN (1)
satin nickel fan
with white frosted blade

Red/blue downrod
optional lengths

Length	Part No.
12"	DR1-12RB
18"	DR1-18RB
24"	DR1-24RB
36"	DR1-36RB
48"	DR1-48RB
60"	DR1-60RB
72"	DR1-72RB

For longer lengths,
join two downrods
with DR1-CPRB

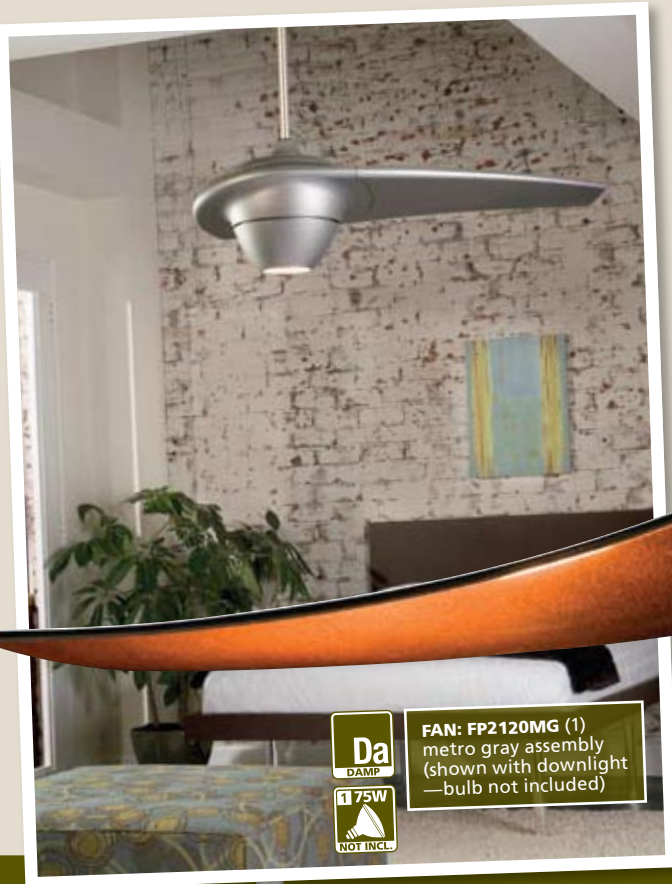

FAN: FP2120MG (1)
metro gray assembly
(shown with downlight
—bulb not included)



FAN: FP2120RB (1)
special order iridescent red/
blue assembly (shown with
small cap—included)



FAN: FP2120WA (1)
metro gray assembly with
walnut blade (shown with
downlight—bulb **not** included)



FAN: FP2120WA (1)
metro gray assembly with
walnut blade (shown with
small cap—included)

ENIGMA[®]



ONE COMPLETER REVOLUTION[®]

ENERGY INFORMATION

at High Speed

Airflow	Electricity Use	Airflow Efficiency
5796 Cubic Feet Per Minute	51 Watts (excluding lights)	114 Cubic Feet Per Minute Per Watt

UNIPACKED
CONTROL & BLADES INCLUDED

LIMITED LIFETIME MOTOR WARRANTY

BUILT-IN DOWNLIGHT

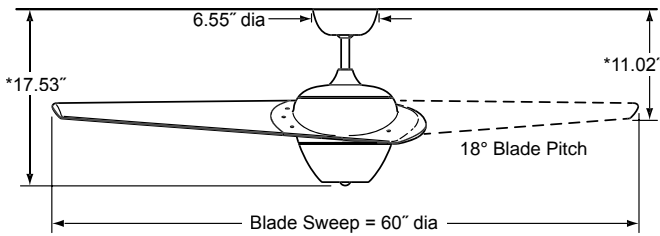

*With included 6" downrod

Finishes (swatches on page 132):

MG fan | MG blade
MG fan | WA blade
RB fan | RB blade

Blades:

Blade assembled and shipped as shown

Motor:

188 x 18

Speeds:

3 forward—counter-clockwise
(non-reversing)

Controls:

TR24WH hand-held remote with wall mount
Optional controls available (p.128-131)

Lighting:

Downlight adaptable, accommodates a
PAR30 short neck 75-watt bulb
(not included)

Downrod:

1" dia. x 6" long downrod included
Longer lengths available—p.132
Close-to-ceiling kit available—p.133

Ceiling slope

Ceiling slope to 30° (up to 52°
with SCB1-52)

Location Use:

FP2120WA is dry location
rated only
FP2120MG and FP2120RB are
dry and damp location rated

Net Hanging Weight:

38.0 lbs.

U.S. Pat # D 467, 327
U.S. Pat # D 6, 726, 451
U.S. Pat # D 7, 217, 082

UL LISTED

OPTIONS



ENIGMA[®]

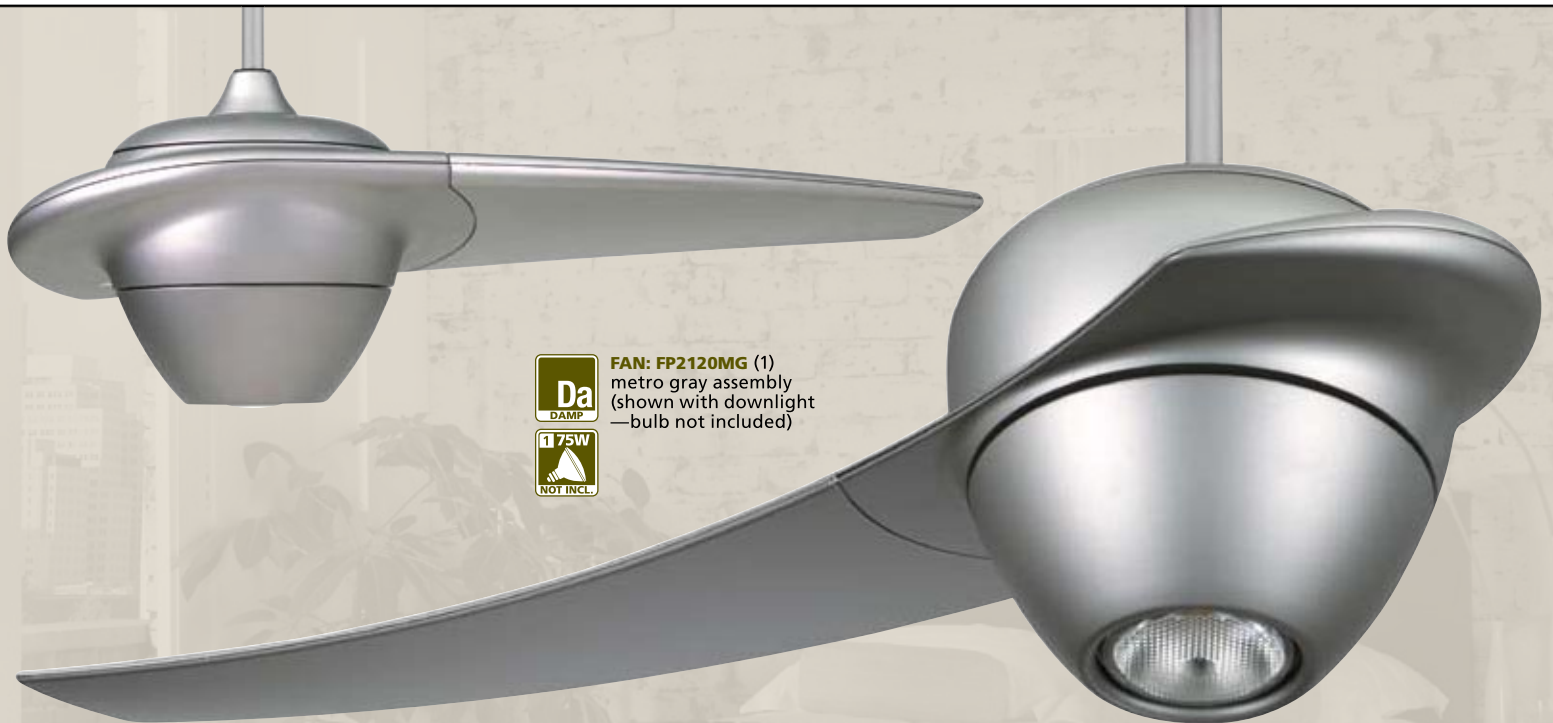

FAN: FP2120MG (1)
metro gray assembly
(shown with downlight
—bulb not included)



REMOTE & WALL MOUNT INCLUDED:

TR24WH

- Fan and light control
- Mounts over switch plate
- 3 speed non-reversing
- Infinite light levels





LED=10W
UPLIGHT
LED=15W
DOWNLIGHT
LIGHTING

FAN: FPD8087BA (1)
bronze accent assembly
with frosted white glass
and reversible cherry/
walnut wood blades
■ cherry side showing



LED=10W
UPLIGHT
LED=15W
DOWNLIGHT
LIGHTING

FAN: FPD8087BA (1)
bronze accent assembly
with frosted white glass
and reversible
cherry/walnut wood blades
■ walnut side showing

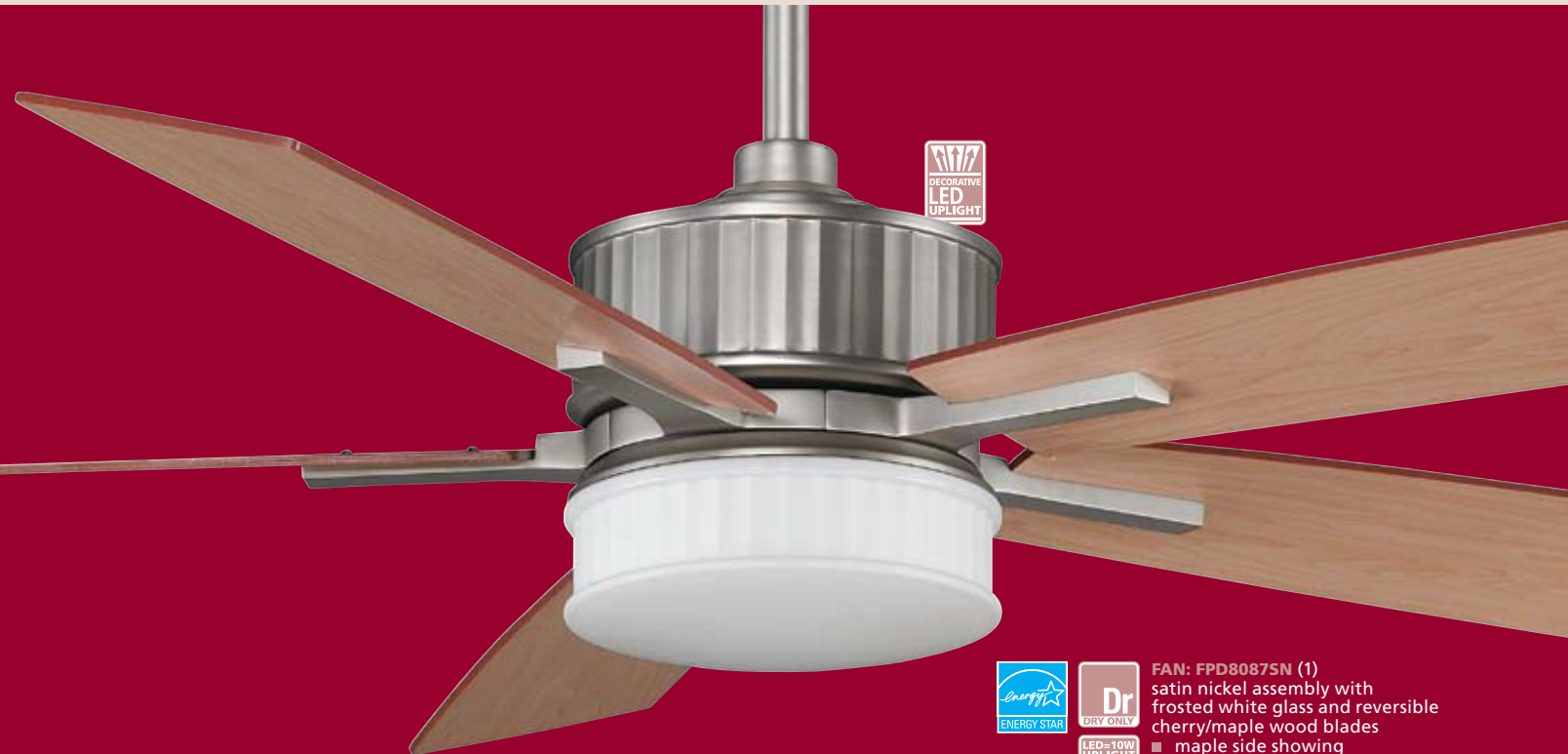

LED=10W
UPLIGHT
LED=15W
DOWNLIGHT
LIGHTING

FAN: FPD8087SN (1)
satin nickel assembly
with frosted white glass
and reversible
cherry/maple wood blades
■ maple side showing

THE LANDAN™

UNDERSTATED ELEGANCE



ENERGY INFORMATION

at High Speed

Airflow	Electricity Use	Airflow Efficiency
5621 Cubic Feet Per Minute	29 Watts (excluding lights)	194 Cubic Feet Per Minute Per Watt

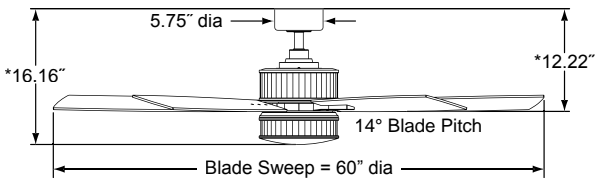

Finishes (swatches on page 132):

BA fan | CY/WA reversible blade | white frosted glass
 SN fan | CY/MP reversible blade | white frosted glass

Blades:

24.63" reversible blade set included (see finish above)

Motor:

DC - 1255

Speeds:

6 forward and 6 reverse (reversing switch in back of remote)

Controls:

TR31 hand-held remote
 Optional TW32 Wall Control available (p.122-125)

Lighting:

Uplight: Eight (8) LEDs for 10W
 Downlight: Twelve (12) LEDs for 15W
 CRI (color rendering index): 79
 CCT (correlated color temp): 2800 K

Downrod:

1" dia. x 4,5" long downrod included
 Longer lengths available—p.132

Ceiling slope

Ceiling slope to 30° (up to 52° with SCB1-52)

Location Use:

Dry location rated only

Net Hanging Weight:

21.85 lbs.

ETL LISTED

OPTIONS



THE LANDAN™

DC motor
 CONSUMES UP TO 70% LESS ENERGY



REMOTE INCLUDED:



FAN: FPD8087SN (1)
 satin nickel assembly with frosted white glass and reversible cherry/maple wood blades
 ■ cherry side showing

TR31

- Fan and light control
- Uplight and downlight
- 6 speed reversing
- Infinite light levels



FAN: FPD8088BA (1)
60" bronze accent assembly with
amber linen glass and reversible
cherry/walnut wood blades

■ cherry side showing



FAN: FPD8089PW (1)
72" pewter assembly with white
linen glass and reversible
cherry/walnut wood blades

■ cherry side showing

THE KEISTONE™

TRADITIONAL SOPHISTICATION

72" & 60" CEILING FANS

ENERGY INFORMATION

at High Speed

Airflow	Electricity Use	Airflow Efficiency
FPD8088 6466	30	214
FPD8089 7231	30	245
Cubic Feet Per Minute	Watts (excluding lights)	Cubic Feet Per Minute Per Watt

DC motor
CONSUMES UP TO 70% LESS ENERGY

UNIPACKED
CONTROL & BLADES INCLUDED

LIMITED LIFETIME MOTOR WARRANTY



Finishes (swatches on page 132):

BA fan | CY/WA reversible blade | amber linen glass
PW fan | CY/WA reversible blade | white linen glass

Blades:

FPD8088—24.7" reversible blade set included (see finish above)
FPD8089—30.7" reversible blade set included (see finish above)

Motor:

FPD8088—DC - 125S
FPD8089—DC - 165M

Speeds:

6 forward and 6 reverse (reversing switch on remote)

Controls:

TR29 hand-held remote
Optional TW30 Wall Control available (p.128-131)

Lighting:

Two 75-watt halogen minican bulbs included

Downrod:

1" dia. x 4.5" long downrod included
Longer lengths available—p.132

Ceiling slope

Ceiling slope to 30° (up to 52° with SCB1-52)

Location Use:

Dry location rated only

Net Hanging Weight:

FPD8088—22.86 lbs.
FPD8089—26.54 lbs.

ETL LISTED

OPTIONS



THE KEISTONE™

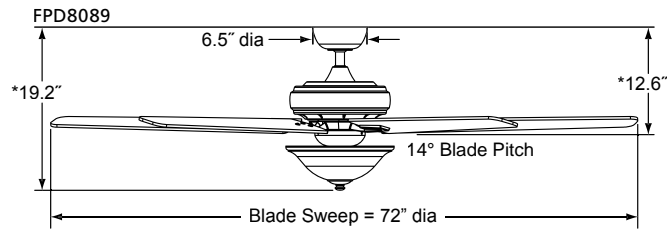
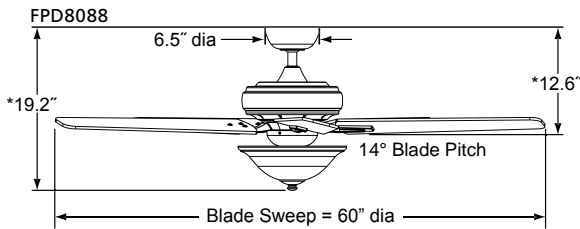

*With included 4.5" downrod

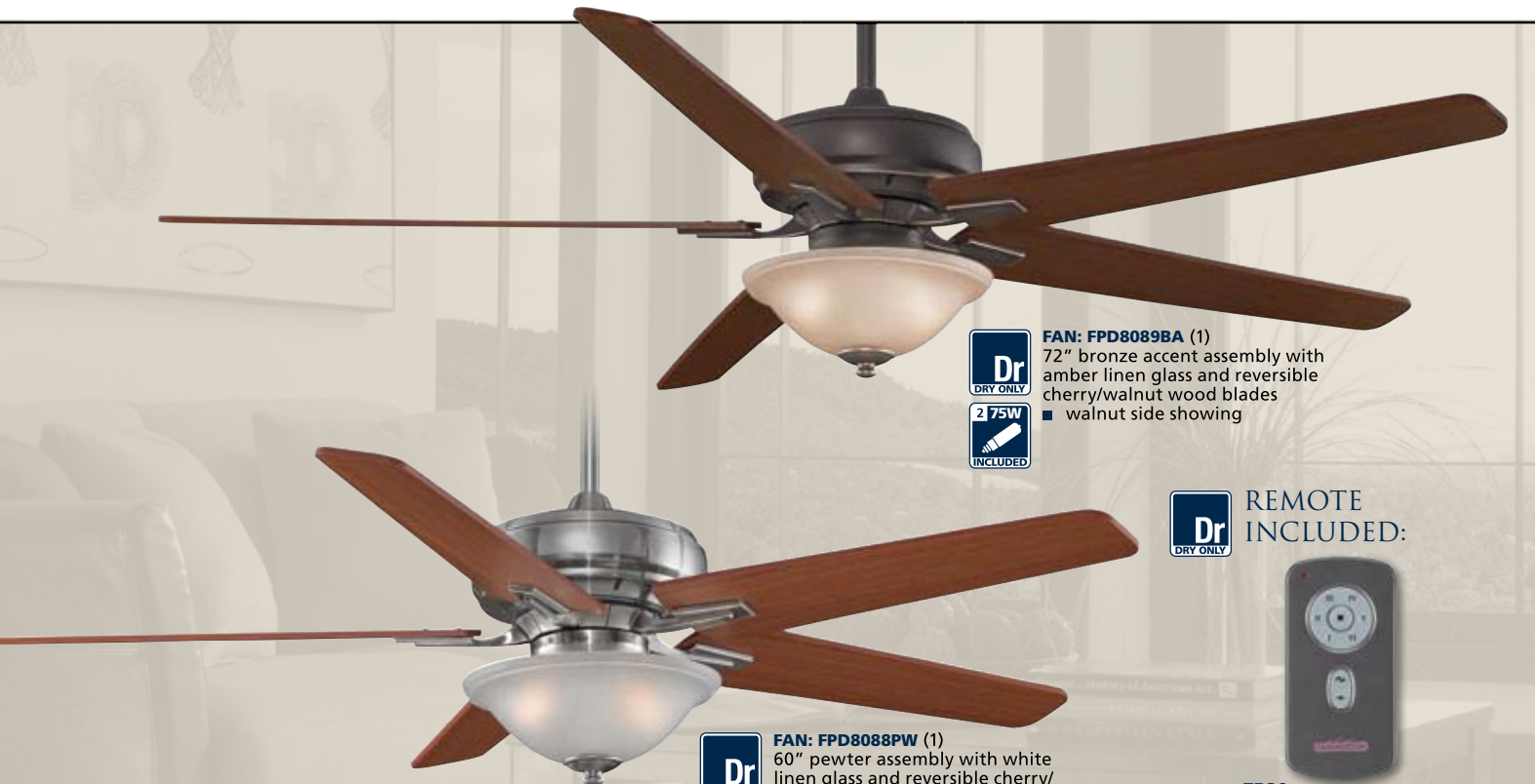

FAN: FPD8089BA (1)
72" bronze accent assembly with amber linen glass and reversible cherry/walnut wood blades
■ walnut side showing



REMOTE INCLUDED:



FAN: FPD8088PW (1)
60" pewter assembly with white linen glass and reversible cherry/walnut wood blades
■ walnut side showing



TR29
• Fan and light control
• Downlight
• 6 speed reversing
• Infinite light levels



THE BENITO™

COOL, CONTEMPORARY AND CAPTIVATING

ENERGY INFORMATION

at High Speed

Airflow	Electricity Use	Airflow Efficiency
4774	60	80
Cubic Feet Per Minute	Watts (excluding lights)	Cubic Feet Per Minute Per Watt

UNIPACKED
CONTROL & BLADES INCLUDED

LIMITED LIFETIME MOTOR WARRANTY

BUILT-IN DOWNLIGHT

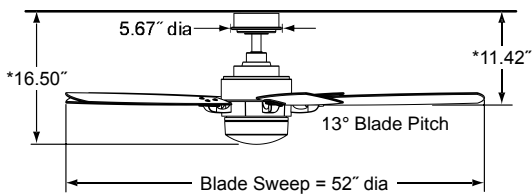

*With included 4.5" downrod

Finishes (swatches on page 132):

OB fan | MH/WA reversible blade | opal glass & matching cap
 PN fan | CY/WA reversible blade | opal glass & matching cap
 SN fan | CY/WA reversible blade | opal glass & matching cap

Blades:

21.5" reversible blade set included (see finish above)

Motor:

172 x 20

Speeds:

3 forward and 3 reverse (reversing switch on housing)

Controls:

TR24WH hand-held remote with wall mount
 Optional controls available (p.128-131)

Lighting:

One 100-watt halogen minican bulb included

Downrod:

1" dia. x 4.5" long downrod included
 Longer lengths available—p.132
 Close-to-ceiling kit available—p.133

Ceiling slope:

Up to 30°

Location Use:

Dry location rated only

Net Hanging Weight:

19.6 lbs.

UL LISTED

OPTIONS



THE BENITO™



FAN: FP8003SN (1)
 satin nickel assembly with opal frosted glass and reversible cherry/walnut wood blades
 ■ walnut side showing



REMOTE & WALL MOUNT INCLUDED:

TR24WH

- Fan and light control
- Mounts over switch plate
- 3 speed non-reversing
- Infinite light levels





FAN: FP8000PW (1)
pewter assembly with opal frosted glass and reversible cherry/walnut wood blades
■ walnut side showing



FAN: FP8000PN (1)
polished nickel assembly with opal frosted glass and reversible cherry/walnut wood blades
■ cherry side showing



FAN: FP8000PW (1)
pewter assembly with pewter light cover (included) and reversible cherry/walnut wood blades
■ cherry side showing

THE AKIRA™

UNEXPECTED DESIGN, CAPTIVATING LINES

ENERGY INFORMATION

at High Speed

Airflow	Electricity Use	Airflow Efficiency
5147	62	83
Cubic Feet Per Minute	Watts (excluding lights)	Cubic Feet Per Minute Per Watt

UNPACKED
CONTROL & BLADES INCLUDED

LIMITED LIFETIME MOTOR WARRANTY

BUILT-IN DOWNLIGHT

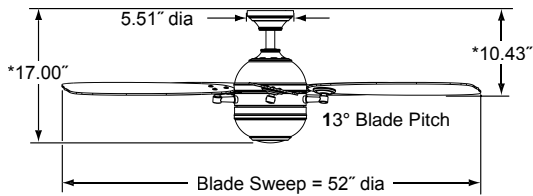

*With included 4.5" downrod

Finishes (swatches on page 132):

OB fan | MH/WA reversible blade | opal glass & matching cap
 PN fan | CY/WA reversible blade | opal glass & matching cap
 SN fan | CY/WA reversible blade | opal glass & matching cap

Blades:

21.3" reversible blade set included (see finish above)

Motor:

172 x 20

Speeds:

3 forward and 3 reverse (reversing switch on housing)

Controls:

TR24WH hand-held remote with wall mount
 Optional controls available (p.128-131)

Lighting:

One 100-watt halogen minican bulb included

Downrod:

1" dia. x 4.5" long downrod included
 Longer lengths available—p.132
 Close-to-ceiling kit available—p.133

Ceiling slope:

Up to 30°

Location Use:

Dry location rated only

Net Hanging Weight:

22.25 lbs.

UL LISTED

OPTIONS



THE AKIRA™



REMOTE & WALL MOUNT INCLUDED:



FAN: FP8000OB (1)
 oil-rubbed bronze assembly with opal frosted glass and reversible mahogany/walnut wood blades
 ■ mahogany side showing

TR24WH

- Fan and light control
- Mounts over switch plate
- 3 speed non-reversing
- Infinite light levels



FAN: FP5420PW (1)
pewter assembly with walnut wood blades and pewter light cover (included)
DOWNROD SLEEVE: DRS54PW (1)
Celano™ decorative downrod sleeve (sold separately)



FAN: FP5420OB (1)
oil-rubbed bronze assembly with walnut wood blades and opal frosted glass (included)



FAN: FP5420PN (1)
polished nickel assembly with cherry wood blades and polished nickel light cover (included)

THE CELANO™

FLUID DESIGN SURE TO CATCH THE EYE

ENERGY INFORMATION

at High Speed

Airflow	Electricity Use	Airflow Efficiency
5882 Cubic Feet Per Minute	79 Watts (excluding lights)	74 Cubic Feet Per Minute Per Watt

UNIPACKED
CONTROL & BLADES INCLUDED

LIMITED LIFETIME MOTOR WARRANTY

BUILT-IN DOWNLIGHT

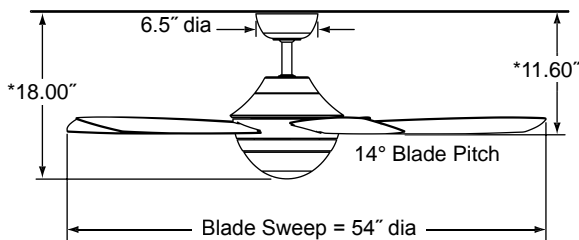

*With included 6" downrod

Finishes (swatches on page 132):

OB fan | WA blade | opal glass & matching cap
PN fan | CY blade | opal glass & matching cap
PW fan | WA blade | opal glass & matching cap

Blades:

21.3" reversible blade set included (see finish above)

Motor:

188 x 20

Speeds:

3 forward and 3 reverse (reversing switch on housing)

Controls:

TR24WH hand-held remote with wall mount
Optional controls available (p.128-131)

Lighting:

One 100-watt halogen minican bulb included

Downrod:

1" dia. x 6" long downrod included
Longer lengths available—p.132
Close-to-ceiling kit available—p.133

Ceiling slope

Up to 30°

Location Use:

Dry location rated only

Net Hanging Weight:

28.8 lbs.

UL LISTED

OPTIONS



THE CELANO™



FAN: FP5420PW (1)
pewter assembly with walnut wood blades and pewter light cover (included)

CLOSE-TO-CEILING KIT: CCK8002PW (1)
pewter close-to-ceiling kit (sold separately)



OPTIONAL BLADES:



B5400CY
Cherry



OPTIONAL DOWNROD SLEEVE:



DRS54**

- Requires 18" or longer downrod (not included)



REMOTE & WALL MOUNT INCLUDED:



TR24WH

- Fan and light control
- Mounts over switch plate
- 3 speed non-reversing
- Infinite light levels



THE HUXLEY™



A BRAVE NEW LOOK

ENERGY INFORMATION

at High Speed

Airflow 5529 Cubic Feet Per Minute	Electricity Use 62 Watts (excluding lights)	Airflow Efficiency 89 Cubic Feet Per Minute Per Watt
---	---	---

UNPACKED
BLADES INCLUDED

LIMITED LIFETIME MOTOR WARRANTY

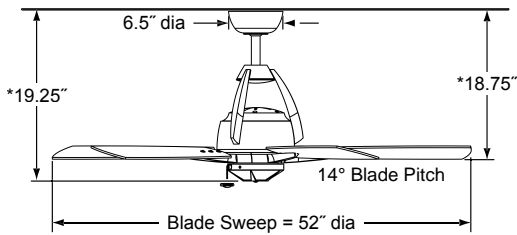

*With included 6" downrod

Finishes (swatches on page 132):

OB fan | CY/WA reversible blade
PW fan | CY/WA reversible blade

Blades:

20" reversible blade set included (see finish above)

Motor:

188 x 15

Speeds:

3 forward and 3 reverse (reversing switch on switch cup housing)

Controls:

Optional controls available (p.128-131)

Lighting:

Accepts standard fitters and light kits—sold separately (pages 124-127)

Downrod:

1" dia. x 6" long downrod included
Longer lengths available—p.132

Minimum 9' ceiling height required

Ceiling slope

Up to 30° (52° with SCB1-52)

Location Use:

Dry location rated only

Net Hanging Weight:

24.9 lbs.

UL LISTED

OPTIONS



THE HUXLEY™



OPTIONAL LIGHT KIT:



LK5620

- 13" Opal frosted glass
- Three (3) 60-watt candelabra bulbs included
- Fitter, glass and finial included



FAN: FP5620OB (1)

- oil-rubbed bronze assembly with reversible cherry/walnut wood blades
- walnut side showing

THE MARIANO™

MODERN DESIGN IN BLOOM



ENERGY INFORMATION

at High Speed

Airflow	Electricity Use	Airflow Efficiency
6144	57	108
Cubic Feet Per Minute	Watts (excluding lights)	Cubic Feet Per Minute Per Watt

UNIPACKED
CONTROL & BLADES INCLUDED

LIMITED LIFETIME MOTOR WARRANTY

BUILT-IN DOWNLIGHT

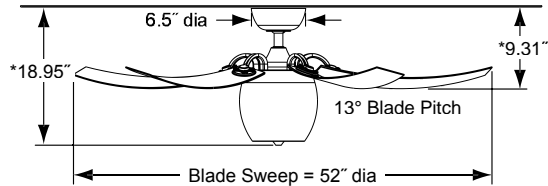

*With included 6" downrod

Finishes (swatches on page 132):
PWW fan | CY blade | white swirl glass

Blades:
21" blade set included (see finish above)

Motor:
172 x 20

Speeds:
3 forward and 3 reverse (reversing switch on housing)

Controls:
TR24WH hand-held remote with wall mount
Optional controls available (p.128-131)

Lighting:
Two 13-watt CFL bulbs included

Downrod:
1" dia. x 6" long downrod included
Longer lengths available (use PW finish downrods)—p.132
Close-to-ceiling kit available (use PW finish)—p.133

Ceiling slope
Up to 30°

Location Use:
Dry and damp location rated only

Net Hanging Weight:
22.97 lbs.

UL LISTED

OPTIONS



FAN: FP7930PWW (1)
pewter assembly with white swirl glass and cherry all-weather composite blades



REMOTE & WALL MOUNT INCLUDED:



TR24WH

- Fan and light control
- Mounts over switch plate
- 3 speed non-reversing
- Infinite light levels

THE LEVON™

MAJESTIC BREEZES



ENERGY INFORMATION at High Speed

Airflow	Electricity Use	Airflow Efficiency
6725 Cubic Feet Per Minute	69 Watts (excluding lights)	98 Cubic Feet Per Minute Per Watt

UNPACKED
BLADES INCLUDED

LIMITED LIFETIME MOTOR WARRANTY

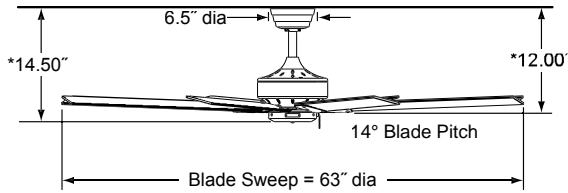

*With included 6" downrod

Finishes (swatches on page 132):

OB fan | WA blade

Blades:

27.4" blade set included (see finish above)

Motor:

188 x 25

Speeds:

3 forward and 3 reverse (reversing switch on switch cup housing)

Controls:

Optional controls available (p.128-131)

Lighting:

Accepts standard fitters and light kits—sold separately (pages 124-127)

Downrod:

1" dia. x 6" long downrod included
Longer lengths available—p.132
Close-to-ceiling kit available—p.133

Ceiling slope

Up to 30° (52° with SCB1-52)

Location Use:

Dry location rated only

Net Hanging Weight:

26.5 lbs.

UL LISTED

OPTIONS



THE MARIANO™ & THE LEVON™



FAN: FP7910OB (1)
oil-rubbed bronze assembly
with walnut blades



FAN: FP815FS (1)
oil-rubbed bronze assembly
with cherry wood blades and
fabric shade
■ fan shown in open position



FAN: FP815FS (1)
oil-rubbed bronze assembly
with cherry wood blades and
fabric shade
■ fan shown in closed position



FAN: FP825OB (1)
oil-rubbed bronze assembly with cherry
wood blades and light kit
■ fan shown in open position
GLASS SHADES: G244 (5)
2-1/4" aged bronze/amber shade glass
(sold separately)



FAN: FP810AM (1)
oil-rubbed bronze assembly
with cherry wood blades and
amber glass bowl
■ fan shown in closed position

THE AIR SHADOW®

AN OPENING STATEMENT

ENERGY INFORMATION

at High Speed

Airflow	Electricity Use	Airflow Efficiency
4514 Cubic Feet Per Minute	48 Watts (excluding lights)	95 Cubic Feet Per Minute Per Watt

ALL AIR SHADOW

Blades:
Included—retractable (when turned off)

Motor:
188 x 18

Speeds:
3 forward and 3 reverse (reverse on remote)

Controls:
TR28 hand-held remote with wall mount
Optional wall control available (p.128-131)

Downrod:

1" dia. x 6" long downrod included
Longer lengths available—p.132
Close-to-ceiling kit available—p.133

Ceiling slope

Up to 30° (52° with SCB1-52)

Location Use:

Dry location rated only

UL LISTED

OPTIONS



THE AIR SHADOW®

UNPACKED
CONTROL & BLADES INCLUDED

LIMITED LIFETIME MOTOR WARRANTY

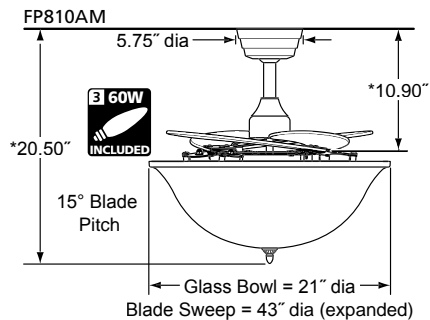
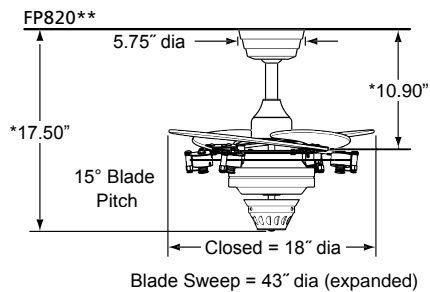

*With included 6" downrod

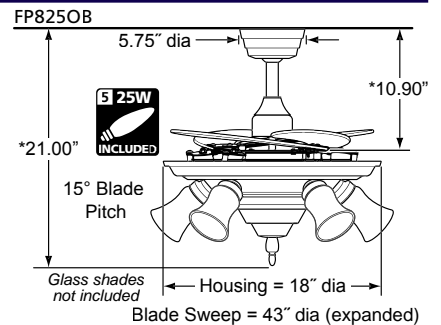
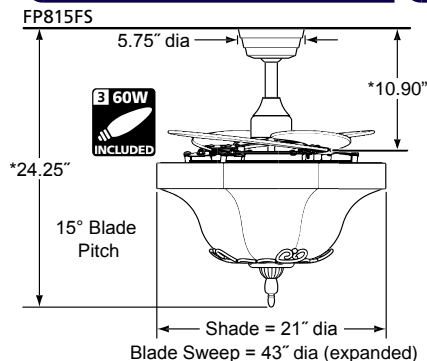

Glass shades not included



FAN: FP820PW (1)
pewter assembly with cherry wood blades
■ fan shown in open position



REMOTE & WALL MOUNT INCLUDED:



TR28

- Fan and light control with demo mode
- 3 speed reversing
- Infinite light levels



Coordinating lighting available at an authorized Hubbardton Forge® dealer
Visit www.vtforge.com for authorized dealer locations



FAN: HF7200BZ (1)
Hubbardton Forge® Leaf uplight fan
■ bronze assembly with coffee wood blades and stone glass



FAN: HF7600DS (1)
Hubbardton Forge® Presidio Tryne uplight fan
■ dark smoke assembly with slate wood blades and opal glass



FAN: HF72400BZ (1)
Hubbardton Forge® standard uplight fan
■ bronze assembly with coffee wood blades and stone glass

HUBBARDTON FORGE®

HUBBARDTON FORGE®

UPLIGHT FANS

ENERGY INFORMATION

at High Speed

Airflow	Electricity Use	Airflow Efficiency
5784	72	81
Cubic Feet Per Minute	Watts (excluding lights)	Cubic Feet Per Minute Per Watt

UNIPACKED
CONTROL & BLADES INCLUDED

LIMITED LIFETIME MOTOR WARRANTY

DECORATIVE UPLIGHT

Finishes (swatches on page 132):

HF7200BZ—BZ fan	coffee blades	stone glass
HF7600DS—DS fan	slate blades	opal glass
HF7240**—BZ fan	coffee blades	stone glass
DS fan	slate blades	opal glass

Blades:
Included

Motor:
188 x 25

Speeds:
3 forward and 3 reverse (reversing switch on remote)

Controls:
TR22WH hand-held remote with wall mount

Lighting:
HF7200BZ—3 25-Watt uplight & 3 40-Watt downlight
HF7600DS—3 25-Watt uplight & 3 40-Watt downlight
HF7240**—3 25-Watt uplight

Downrod:

1" dia. x 6" long downrod included
Longer lengths available—p.132
Close-to-ceiling kit available—p.133

Ceiling slope

Up to 30° (52° with SCB1-52)

Location Use:

Dry location rated only—Damp location rated when used with BPW21CF blade set (sold separately, page 51)

Net Hanging Weight:

HF7200BZ — 36.0 lbs.
HF7600DS — 37.0 lbs.
HF7240** — 32.0 lbs.

UL LISTED

OPTIONS

R128-131

CONTROLS

SEE BELOW

BLADES

DOWNLIGHT

Da

DAMP

HUBBARDTON FORGE®

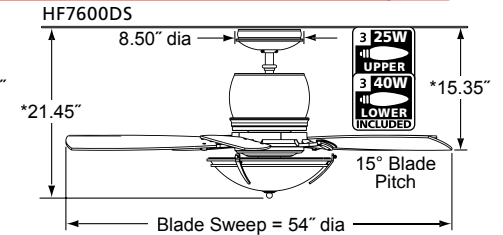
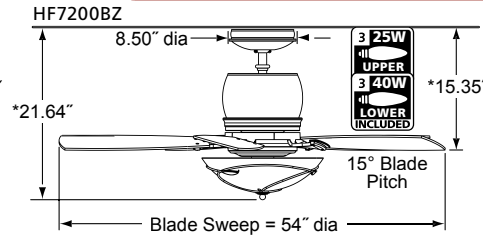
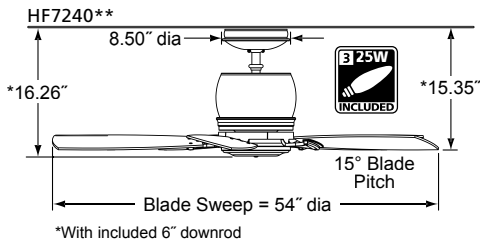

OPTIONAL
BLADE:



Da
DAMP

BPW21CF
20" coffee all-weather composite

Coordinating lighting available at an authorized Hubbardton Forge® dealer.
Visit www.vtforge.com for authorized dealer locations.

Dr
DRY ONLY

3 25W UPPER
3 40W LOWER INCLUDED

FAN: HF7600DS (1)
Hubbardton Forge® Presidio Tryne uplight fan

- dark smoke assembly with slate wood blades and opal glass

Dr
DRY ONLY

REMOTE &
WALL MOUNT
INCLUDED:



TR22WH

- Fan and light control
- Uplight and downlight
- Mounts over switch plate
- 3 speed reversing
- Infinite light levels



Da
DAMP

FAN: HF6050BZ (1)
Hubbardton Forge® standard fan
■ bronze assembly with coffee wood blades
BLADE SET: BPW21CF (1)
20" coffee all-weather composite blades



Coordinating lighting available at an authorized Hubbardton Forge® dealer
Visit www.vtforge.com for authorized dealer locations

Dr
DRY ONLY
3 40W
INCLUDED

FAN: HF6200MH (1)
Hubbardton Forge® Leaf standard fan
■ mahogany assembly with coffee wood blades and stone glass



Dr
DRY ONLY

FAN: HF6050DS (1)
Hubbardton Forge® standard fan
■ dark smoke assembly with slate wood blades

HUBBARDTON FORGE®

STANDARD FANS

ENERGY INFORMATION at High Speed

Airflow	Electricity Use	Airflow Efficiency
5784 Cubic Feet Per Minute	72 Watts (excluding lights)	81 Cubic Feet Per Minute Per Watt

UNIPACKED
CONTROL & BLADES INCLUDED

LIMITED LIFETIME MOTOR WARRANTY

Finishes (swatches on page 132):

HF6050**	BZ fan	coffee blades	
	DS fan	slate blades	
	MH fan	coffee blades	
HF6200**	BZ fan	coffee blades	stone glass
	DS fan	slate blades	opal glass
	MH fan	coffee blades	stone glass
HF6600**	BZ fan	coffee blades	stone glass
	DS fan	slate blades	opal glass
	MH fan	coffee blades	stone glass

Blades:
Included

Motor:
188 x 25

Speeds:
3 forward and 3 reverse (reversing switch on remote)

Controls:
TR20WH hand-held remote with wall mount

Lighting:

HF6050**— n/a
HF6200**— 3 40-Watt downlight
HF6600**— 3 40-Watt downlight

Downrod:

1" dia. x 6" long downrod included
Longer lengths available—p.132
Close-to-ceiling kit available—p.133

Ceiling slope

Up to 30° (52° with SCB1-52)

Location Use:

Dry location rated only—Damp location rated when used with BPW21CF blade set (sold separately, page 53)

Net Hanging Weight:

HF6050** — 28.5 lbs.
HF6200** — 32.0 lbs.
HF6600** — 32.0 lbs.

UL LISTED

OPTIONS

#128-131



SEE BELOW



Da
DAMP

HUBBARDTON FORGE®

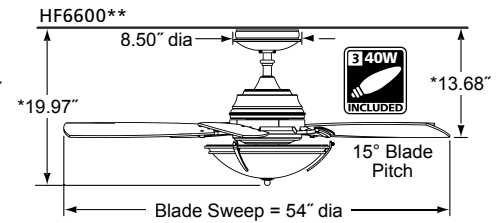
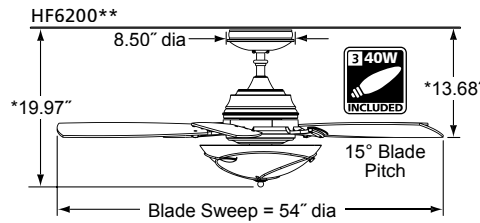
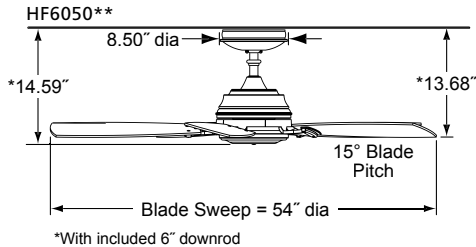

OPTIONAL BLADE:



Coordinating lighting available at an authorized Hubbardton Forge® dealer.

Visit www.vtforge.com for authorized dealer locations.

Da
DAMP

BPW21CF
20" coffee all-weather composite

Dr
DRY ONLY

FAN: HF6600MH (1)
Hubbardton Forge® Presidio Tryne standard fan

3 40W
INCLUDED

■ mahogany assembly with coffee wood blades and stone glass

Dr
DRY ONLY

REMOTE & WALL MOUNT INCLUDED:



TR20WH

- Fan and light control
- Downlight
- Mounts over switch plate
- 3 speed reversing
- Infinite light levels



FAN: FP5220OB (1)
oil-rubbed bronze assembly with amber glass and reversible cherry/walnut wood blades
■ walnut side showing

Dr
DRY ONLY

3 40W
INCLUDED



FAN: FP5220PW (1)
pewter assembly with opal frosted glass and reversible cherry/walnut wood blades
■ walnut side showing

Dr
DRY ONLY

3 40W
INCLUDED



FAN: FP5220PW (1)
pewter assembly with opal frosted glass and reversible cherry/walnut wood blades
■ cherry side showing

Dr
DRY ONLY

3 40W
INCLUDED

THE ANDOVER™

SMART. STYLISH. SAVVY.

ENERGY INFORMATION

at High Speed

Airflow	Electricity Use	Airflow Efficiency
5732 Cubic Feet Per Minute	66 Watts (excluding lights)	87 Cubic Feet Per Minute Per Watt

UNIPACKED
CONTROL & BLADES INCLUDED

LIMITED LIFETIME MOTOR WARRANTY

BUILT-IN DOWNLIGHT

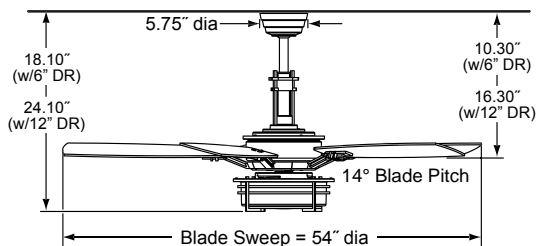

Finishes (swatches on page 132):

OB fan | CY/WA reversible blade | amber glass
PW fan | CY/WA reversible blade | opal glass

Blades:

20.5" reversible blade set included (see finish above)

Motor:

188 x 20

Speeds:

3 forward and 3 reverse (reversing switch on housing)

Controls:

TR24WH hand-held remote with wall mount
Optional controls available (p.128-131)

Lighting:

3 40-watt candelabra bulbs included

Downrod:

(2) downrods included—
1" dia. x 6" long and 1" dia. x 12" long downrods included
Longer lengths available—p.132
Decorative downrod sleeve included—
for use with 12" downrod
Close-to-ceiling kit available—p.133

Ceiling slope:

Ceiling slope to 30° (up to 52° with SCB1-52)

Location Use:

Dry location rated only

Net Hanging Weight:

31.2 lbs.

UL LISTED

OPTIONS



THE ANDOVER™



FAN: FP5220PW (1)
pewter assembly with opal frosted glass and reversible cherry/walnut wood blades



■ walnut side showing



REMOTE & WALL MOUNT INCLUDED:

TR24WH

- Fan and light control
- Mounts over switch plate
- 3 speed non-reversing
- Infinite light levels





FAN: LB270VZ (1)
venetian bronze assembly with cairo
purple custom wood blades, amber glass
bowl light kit and decorative filigree



FAN: LB250VZ (1)
venetian bronze assembly
with cairo purple custom
wood blades

LAUREN BROOKS®

THE Bayhill COLLECTION™

ENERGY INFORMATION

at High Speed

Airflow	Electricity Use	Airflow Efficiency
6471	73	88
Cubic Feet Per Minute	Watts (excluding lights)	Cubic Feet Per Minute Per Watt

UNIPACKED
CONTROL & BLADES INCLUDED

LIMITED LIFETIME MOTOR WARRANTY

Finishes (swatches on page 132):

LB250VZ—VZ fan | cairo purple wood blades
LB270VZ—VZ fan | cairo purple wood blades |
amber glass bowl with decorative filigree

Blades:
Included

Motor:
188 x 25

Speeds:
3 forward and 3 reverse (reversing switch on switch cup housing)

Controls:
Includes CW2WH fan and light wall control.
Optional controls available (p.128-131)

Lighting:
LB250VZ—Accepts standard fitters (pages 124-127)
LB270VZ—Amber glass bowl light kit with three (3)
40-watt candelabra bulbs included

Downrod:
1" dia. x 6" long downrod
included
Longer lengths available—p.132

Ceiling slope:
Up to 30° (52° with SCB1-52)

Location Use:
Dry location rated only

Net Hanging Weight:
LB250VZ—26.0 lbs.
LB270VZ—40.4 lbs.

UL LISTED

OPTIONS

P.124-127



P.128-131



DOWNLIGHT



Dr



LAUREN BROOKS®

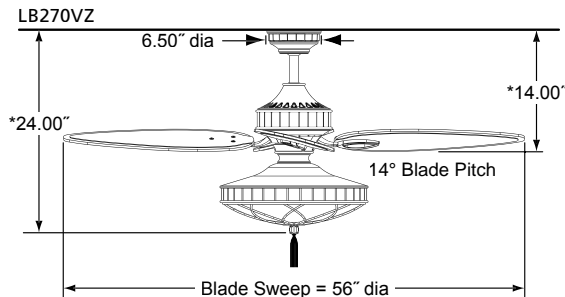
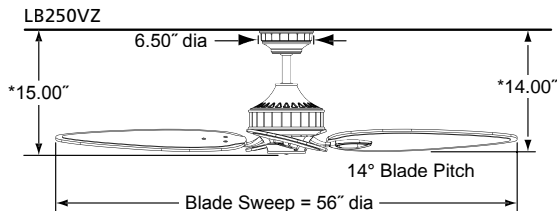

*With included 6" downrod



FAN: LB250VZ (1)
venetian bronze assembly with cairo
purple custom wood blades



FITTER: F423VZ (1)
venetian bronze bowl fitter
GLASS: G426 (1)
amber/brown mosaic bowl



WALL CONTROL INCLUDED:

CW2WH
• Fan and light wall control
with face plate included
• 3 fan speeds
• Infinite light levels





FAN: FP8032SB (1)
sedona beige assembly with
amber tea glass and reversible
mahogany/walnut wood blades
■ walnut side showing



FAN: FP8032SB (1)
sedona beige assembly with
amber tea glass and reversible
mahogany/walnut wood blades
■ mahogany side showing

THE VENTANA™

TRADITIONAL SOPHISTICATION

ENERGY INFORMATION at High Speed

Airflow	Electricity Use	Airflow Efficiency
5634	74	76
Cubic Feet Per Minute	Watts (excluding lights)	Cubic Feet Per Minute Per Watt

UNIPACKED
CONTROL & BLADES INCLUDED

LIMITED LIFETIME MOTOR WARRANTY

BUILT-IN DOWNLIGHT

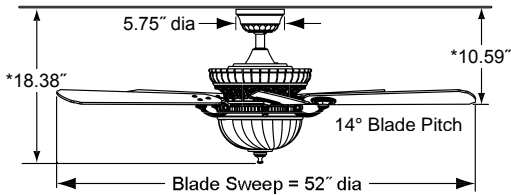

*With included 4.5" downrod

Finishes (swatches on page 132):

SB fan | MH/WA reversible blade | amber tea glass

Blades:

20.7" reversible blade set included (see finish above)

Motor:

172 x 17

Speeds:

3 forward and 3 reverse (reversing switch on housing)

Controls:

TR24WH hand-held remote with wall mount
Optional controls available (p.128-131)

Lighting:

Two 50-watt halogen minican bulbs included

Downrod:

1" dia. x 4.5" long downrod included

Longer lengths available—p.132
Close-to-ceiling kit available—p.133

Ceiling slope

Ceiling slope to 30° (up to 52° with SCB1-52)

Location Use:

Dry location rated only

Net Hanging Weight:

24.5 lbs.

UL LISTED

OPTIONS



THE VENTANA™



FAN: FP8032SB (1)
sedona beige assembly with amber tea glass and reversible mahogany/walnut wood blades
■ mahogany side showing



REMOTE & WALL MOUNT INCLUDED:

TR24WH

- Fan and light control
- Mounts over switch plate
- 3 speed non-reversing
- Infinite light levels





Da
DAMP

FAN: FP420AB (1)
antique brass tall assembly
BLADE SET: FP1018 (1)
21" reversible wood
■ oak side showing

THE AMERICANA®

TURN-OF-THE-CENTURY CHARM

MULTICOMPONENT
MOTOR & BLADES

LIMITED LIFETIME MOTOR WARRANTY

For dimensions and configurations, please see our comprehensive Specification Book or model-specific specification sheet, available at www.fanimation.com

Finishes (swatches on page 132):

- AB Dry location only
- BL Dry and damp locations

Blades:

Sold separately (pages 134-137)

Motor:

FK2100

Speeds:

3 forward and 3 reverse (reversing switch on switch cup)

Controls:

Optional controls available (p.128-131)

Lighting:

Accepts standard fitters and light kits—sold separately (pages 124-127)

Downrod:

Fan mounts flush to ceiling and does not require use of a downrod.

FP410—short fan: 25" from ceiling to bottom of fan
FP420—tall fan: 39" from ceiling to bottom of fan

Ceiling slope:

None

Location Use:

See finishes

Net Hanging Weight:

FP410—short fan: 32 lbs.
FP420—tall fan: 41 lbs.

UL LISTED

OPTIONS



THE AMERICANA®



FAN: FP410BL (1)
black short assembly
BLADE SET: ISP4 (1)
22" natural finish narrow oval palm



FAN: FP420AB (1)
antique brass tall assembly
BLADE SET: FP1018 (1)
21" reversible wood
■ oak side showing

EASY ORDERING STEPS:



Select a motor

Select from antique brass or black

FP410 short: 25" from ceiling to bottom of switch housing

FP420 long: 39" from ceiling to bottom of switch housing



Select a blade set

(pages 134-137)



Optional lighting

(pages 124-127)



Optional remote and wall controls

(pages 128-131)



MOTOR: FP580BL (1)
black (required but not shown)
HEAD: FP520BL (1)
black tall assembly
BLADE SET: FP1018 (1)
21" reversible wood
■ oak side showing



Part of Fanimation's Belt-Drive collection, The Bourbon Street® is a reproduction of an original Snediker & Carr® installation at Kolb's—once a popular eatery and beer house in the New Orleans French Quarter.

Combining old-world elegance with the newest technology gives The Bourbon Street® fan a truly unique flare. Fanimation incorporates hardwood laminate blades that resist warping and neoprene belts that resist breakage and excessive sag.

The Bourbon Street® brings a classic design into the present with an extremely flexible system that works well in both small and large settings. Optional ceiling and wall mount (not shown) idlers allow belt and fan layouts to turn corners or jog around columns and other obstacles.



MOTOR: FP580AB (1)
antique brass
HEAD: FP510AB (6)
antique brass short assembly
BLADE SET: FP1018 (6)
21" reversible wood
■ walnut side showing

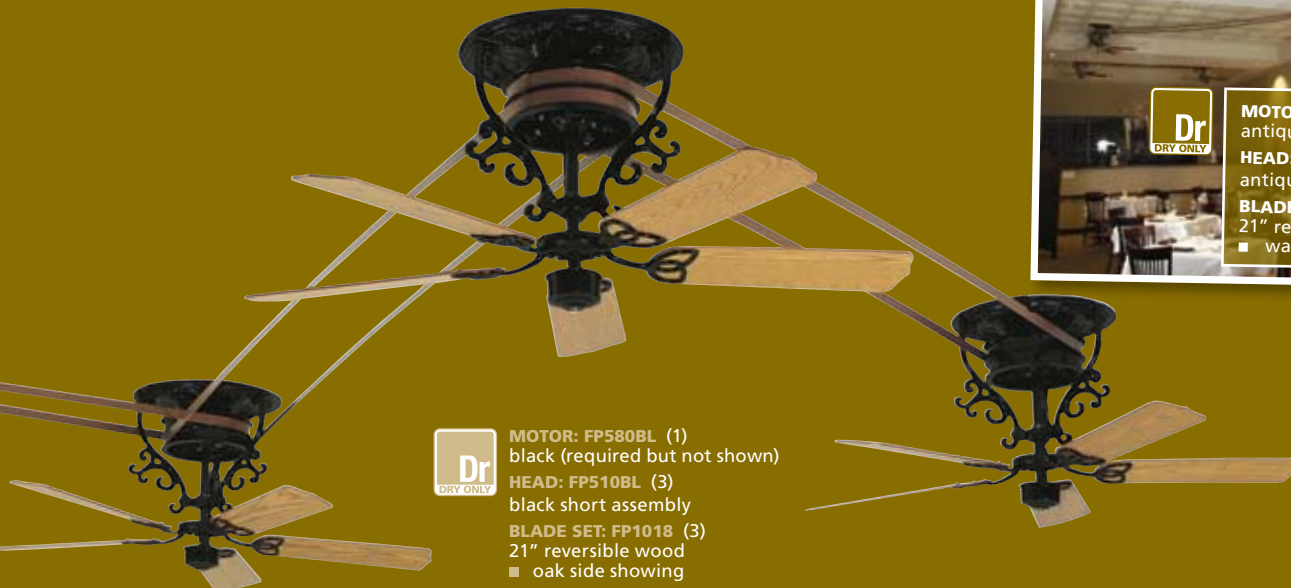

MOTOR: FP580BL (1)
black (required but not shown)
HEAD: FP510BL (3)
black short assembly
BLADE SET: FP1018 (3)
21" reversible wood
■ oak side showing

THE BOURBON STREET®

THE TOAST OF NEW ORLEANS

MULTICOMPONENT
MOTOR & BLADES

LIMITED LIFETIME MOTOR WARRANTY

For dimensions and configurations, please see our comprehensive Specification Book or model-specific specification sheet, available at www.fanimation.com

Finishes (swatches on page 132):

AB
BL

Blades:

Sold separately (pages 134-137)

Motors:

FP580 (two FK2100)—sold separately

Heads:

FP510 short—sold separately: 21" from ceiling to bottom of fan
FP520 tall—sold separately: 36" from ceiling to bottom of fan

Speeds:

Single speed

Blade pitch:

12°

Fan spacing:

from 6' to 16' with up to six fans operating off a single motor

Features:

Includes 40' of belting (max. distance between center of motor and center of fan base is 16')

Location Use:

Dry location rated only

Not for use in sound-sensitive areas

UL LISTED

OPTIONS



THE BOURBON STREET®



MOTOR: FP580AB (1)
antique brass (required but not shown)

HEAD: FP520AB (3)
antique brass tall assembly

BLADE SET: FP1018 (3)
21" reversible wood
■ oak side showing

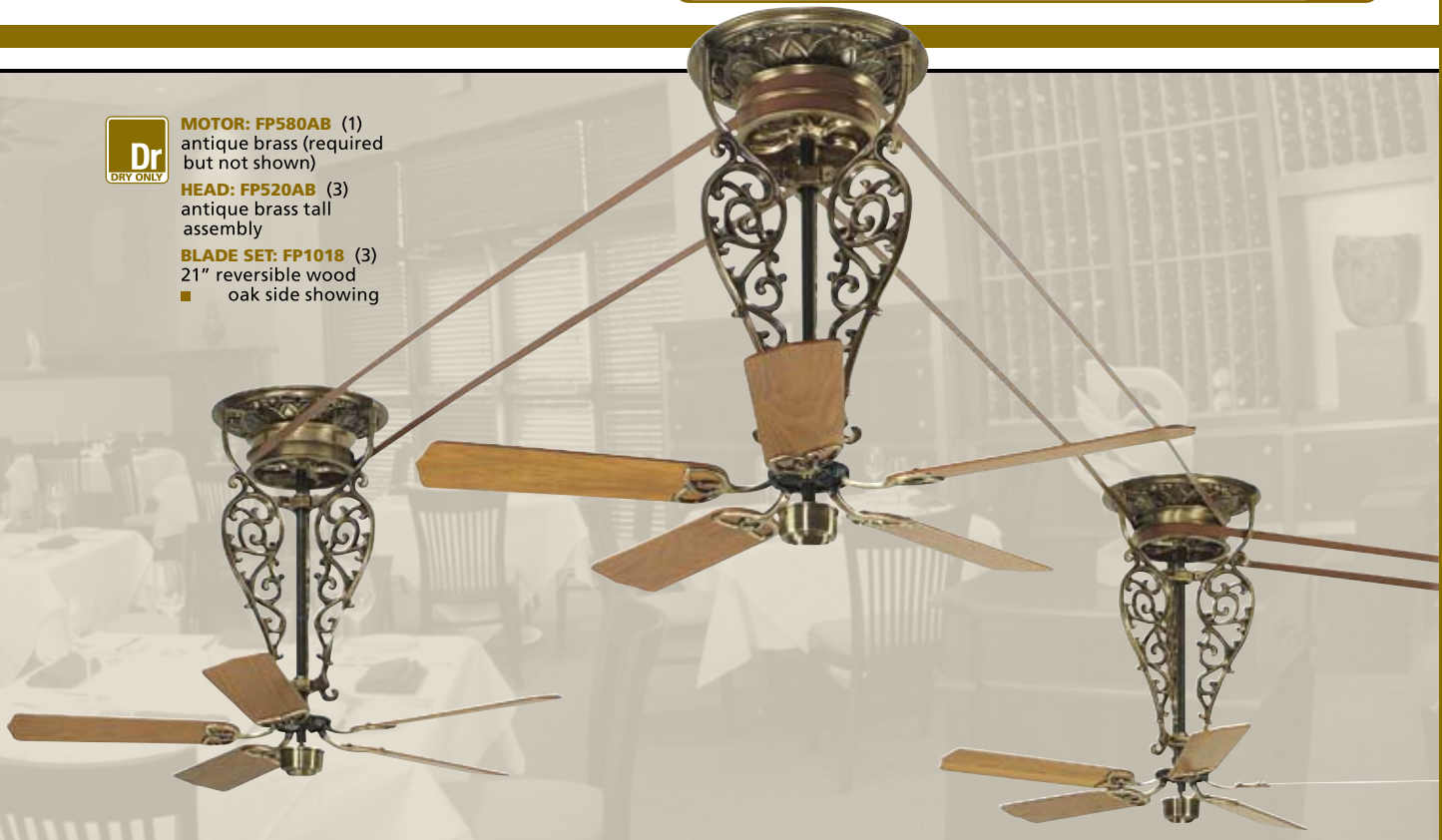

EASY ORDERING STEPS:



Select a motor

Select from antique brass or black
Single speed motor
Includes 40' of belting (max. distance between center of motor and center of fan base is 16')

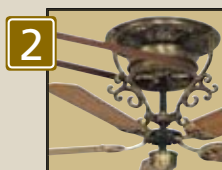

Select a fan assembly style

Each sold separately, up to six fan units per motor
FP510 short: 21" from ceiling to bottom of switch housing
FP520 tall: 36" from ceiling to bottom of switch housing

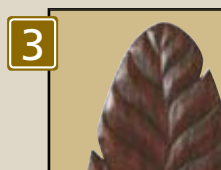

Select a blade set

(pages 134-137)



Optional lighting

(pages 124-127)



The Brewmaster® carries on Fanimation's reputation for reproducing unusual, yet function, belt-drive fans. These fans were originally produced in the late 1800s by Snediker & Carr®, the premier belt-drive fan manufacturer of their day. Fanimation has adapted this timeless masterpiece to install and operate with more ease and durability.

- Neoprene belting replaces the high-maintenance leather belts.
- Lead and copper babbitt sleeves have given way to sealed ball bearings.
- Hardwood laminate blades that resist warping and splitting replace the temperamental solid wood blades.

The Brewmaster® combines the latest technology with several blade options including the original oversized wood blade design. The Brewmaster® is powered by a gearless direct drive motor, and allows you to operate one or two fans.



MOTOR: FP1280AB (1)
antique brass (required but not shown)
HEAD: FP10AB (2)
antique brass short-neck assembly
BLADE SET: FP1026 (2)
25" cherry wood blades



MOTOR: FP1280PW (1)
pewter (required but not shown)
HEAD: FP10PW (1)
pewter short-neck assembly
BLADE SET: BMD4A (1)
22" antique narrow oval woven bamboo



MOTOR: FP1280AB (1)
antique brass
HEAD: FP10AB (2)
antique brass short-neck assembly
BLADE SET: BMP1 (2)
22" natural finish wide oval palm

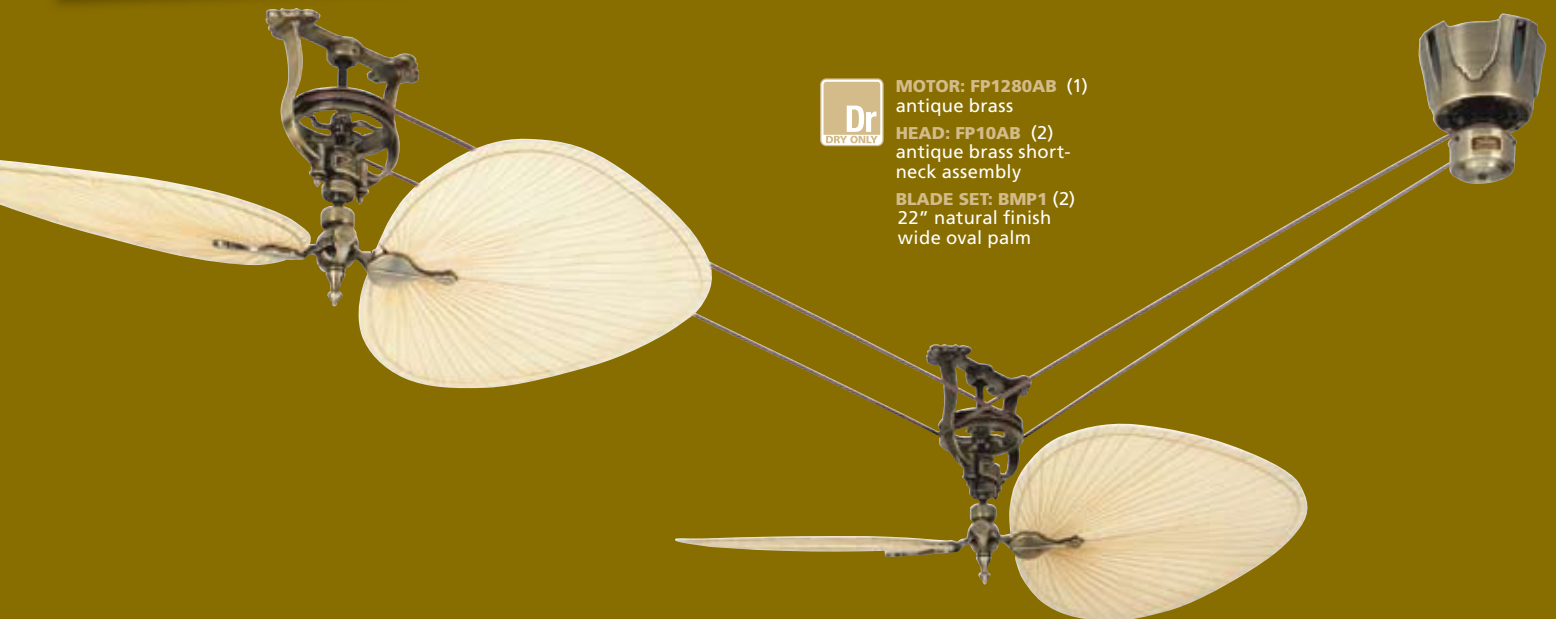

THE BREWMASTER®

THE WARM ATMOSPHERE OF A FRIENDLY PUB

MULTICOMPONENT
MOTOR & BLADES

LIMITED LIFETIME MOTOR WARRANTY

For dimensions and configurations, please see our comprehensive Specification Book or model-specific specification sheet, available at www.fanimation.com

Finishes (swatches on page 132):

- AB Dry location only
- BL Dry and damp locations (damp if used with BMD4A blade set)
- PW Dry location only

Blades:

Sold separately (pages 65, 134-137)
Includes two wood blade holders and two traditional blade holders

Motors:

FP1280 (FK2100)—sold separately

Heads:

FP10 short—sold separately: 17.5" from ceiling to bottom of fan
FP20 tall—sold separately: 26" from ceiling to bottom of fan

Speeds:

3 forward and 3 reverse (reversing switch on remote)

Controls:

TR20WH hand-held remote with wall mount

Blade sweep:

56" blade sweep with original wood blade

Blade pitch:

20°

Features:

Includes 30' of belting (max. distance between center of motor and center of fan base is 13' 6")
Includes all necessary hardware for installation

Location Use:

See finishes

UL LISTED

OPTIONS

#124-127

LIGHTING

#128-131

CONTROLS

#134-137

BLADES

Da

DAMP

220V

ALL

THE BREWMASTER®

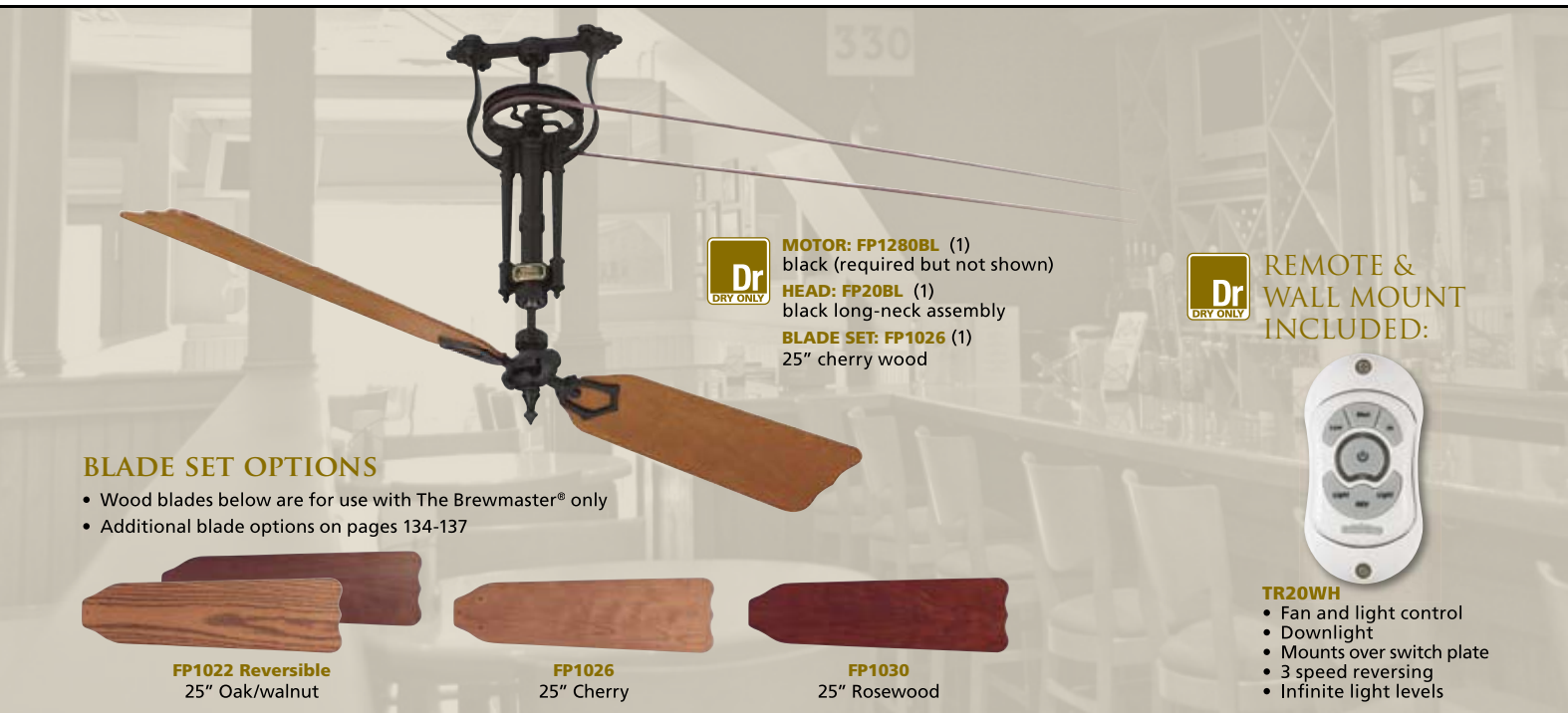

MOTOR: FP1280BL (1)
black (required but not shown)
HEAD: FP20BL (1)
black long-neck assembly
BLADE SET: FP1026 (1)
25" cherry wood



REMOTE & WALL MOUNT INCLUDED:



- TR20WH**
- Fan and light control
 - Downlight
 - Mounts over switch plate
 - 3 speed reversing
 - Infinite light levels

BLADE SET OPTIONS

- Wood blades below are for use with The Brewmaster® only
- Additional blade options on pages 134-137



FP1022 Reversible
25" Oak/walnut



FP1026
25" Cherry



FP1030
25" Rosewood

EASY ORDERING STEPS:



Select a motor

Select from antique brass, black or pewter
Includes 30' of belting (max. distance between center of motor and center of fan base is 13' 6")



Select a fan assembly style

Each sold separately, up to four fan units per motor
FP10 short-neck: 17.5" from ceiling to bottom of switch housing
FP20 long-neck: 26" from ceiling to bottom of switch housing



Select a blade set

Blades sold in sets of two (pages 65, 134-137)



Optional lighting

(pages 124-127)

FARGO®

PLAY IT COOL



LIMITED LIFETIME MOTOR WARRANTY

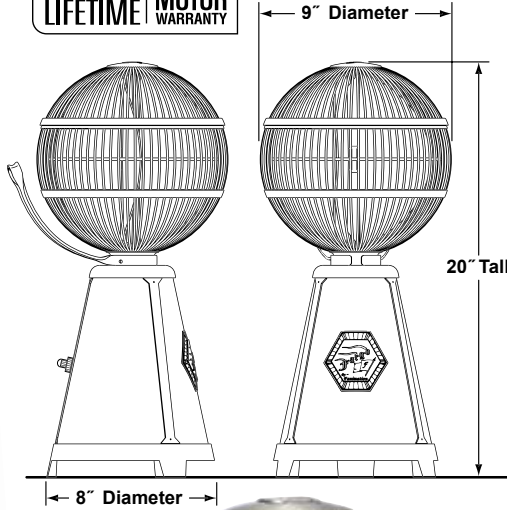

Finishes (swatches on page 132):

- OB with AB accents
- SN with CH accents
- Burgundy faux leather with brushed brass accents

Dimensions:

9" diameter grill x 20" tall

Motor:

75 x 18

Speeds:

3-speed switch on rear of unit

Features:

- Easy carry handle for portability
- Protective rubber feet included
- 8' power cord included
- Ships fully assembled

Location Use:

Dry location rated only

Weight:

12.5 lbs

Patent pending

UL LISTED

OPTIONS



FAN: FP3320BG (1)
burgundy faux leather base with brushed brass accents



FAN: FP3320OB (1)
oil-rubbed bronze base with antique brass accents



FAN: FP3320SN (1)
satin nickel base with chrome accents

THE FITZGERALD®

JAZZY STYLE WITH A TWIST

LIMITED LIFETIME MOTOR WARRANTY

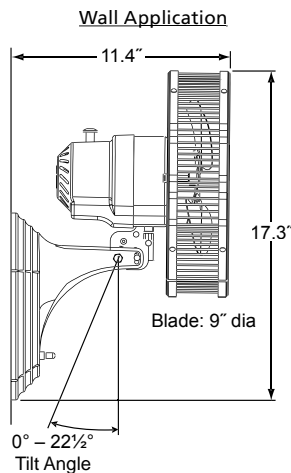
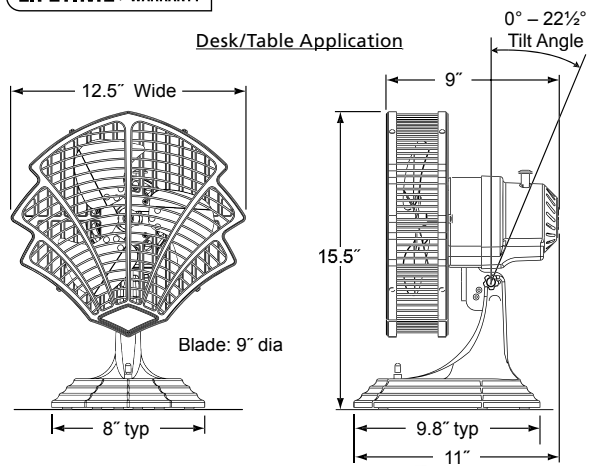

Finishes (swatches on page 132):

OB
SN

Dimensions:

15.5" (H) x 12.5" (W) x 11" (D)

Motor:

75 x 18

Speeds:

3-speed switch on rear of unit

Features:

Table top fan can also be mounted to the wall
Oscillating movement
Protective rubber feet included
8' power cord included
Ships fully assembled

Location Use:

Dry location rated only

Weight:

10.0 lbs

Patent pending

UL LISTED

OPTIONS

Dr
DRY ONLY

FARGO® & THE FITZGERALD®



FAN: OF63200B (1)
oil-rubbed bronze assembly
■ wall mount

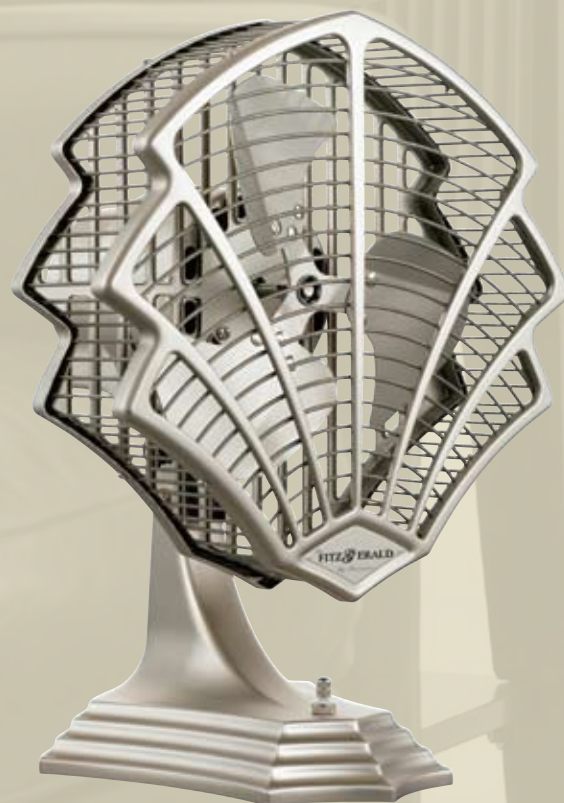

FAN: OF63205N (1)
satin nickel assembly
■ table mount



FAN: FP8014SN (1)
satin nickel fan
with walnut legs



FAN: FP8014OB (1)
oil-rubbed bronze fan
with walnut legs

THE ARDEN™

COOL AND COMPOSED

LIMITED LIFETIME MOTOR WARRANTY

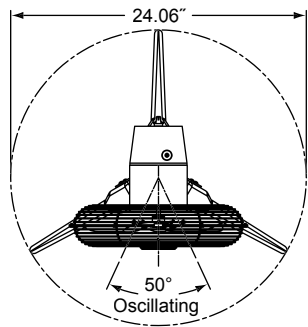
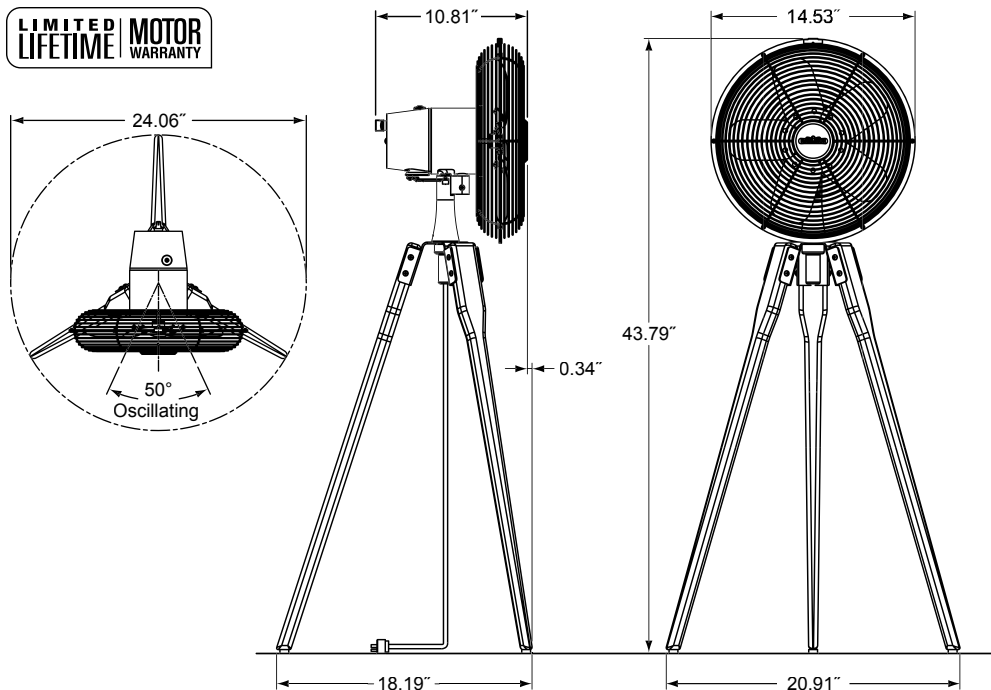

Finishes (swatches on page 132):

OB | WA legs
SN | WA legs

Motor:
74 x 18

Speeds:
3-speed rotary switch

Features:
50° total oscillation
8' power cord included

Location Use:
Dry location rated only

Weight:
13.1 lbs

UL LISTED

OPTIONS

Dr
DRY ONLY

THE ARDEN™



Dr
DRY ONLY

FAN: FP8014OB (1)
oil-rubbed bronze fan
with walnut legs

Dr
DRY ONLY

FAN: FP8014SN (1)
satin nickel fan
with walnut legs





Dr
DRY ONLY

FAN: FPH210RS (1)
rust motor assembly
BASE: FPH21RS (1)
rust pedestal base
COLUMN: FPH70CP (1)
carved post



Dr
DRY ONLY

FAN: FPH210BL (1)
black motor assembly
BASE: FPH21BL (1)
black pedestal base
COLUMN: FPH70CP (1)
carved post



Dr
DRY ONLY

FAN: FPH210AC (1)
antique copper and
black motor assembly
BASE: FPH41BL (1)
black floor/desk base

THE OLD HAVANA[®]

CHARACTER AND CHARISMA

MULTICOMPONENT
MOTOR & MOUNTING SYSTEM

LIMITED LIFETIME MOTOR WARRANTY

Finishes (swatches on page 132):

AC | AC (antique copper) cage
BL | BL cage
PW | PW cage
RS | RS cage

Motor:

90 x 20

Does not oscillate

Speeds:

3 forward/downward non-reversing

Controls:

Optional wall mounted remote control for use with ceiling mount (FPH81) sold separately (p.129)

Features:

Mounting system, motor assembly and accessories sold separately
8' power cord included—exits back of motor assembly

Location Use:

AC and PW finishes are dry location rated only
BL and RS finishes are dry and damp location rated.

U.S. Pat # D 433, 926

UL LISTED

OPTIONS



THE OLD HAVANA[®]



FAN: FPH210PW (1)
pewter and black motor assembly

CEILING MOUNT: FPH81BL1 (1)
black ceiling mount—1" dia. x 6" long downrod included



FAN: FPH210RS (1)
rust motor assembly

WALL MOUNT: FPH61RS (1)
rust wall mount

THE OLD HAVANA®

EASY ORDERING STEPS TO CUSTOMIZE THE OLD HAVANA®

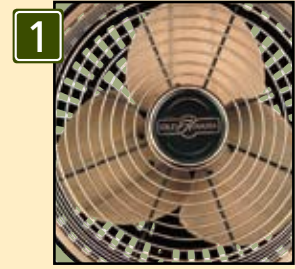

Select a motor assembly

Select from black, rust, antique copper with black or pewter with black

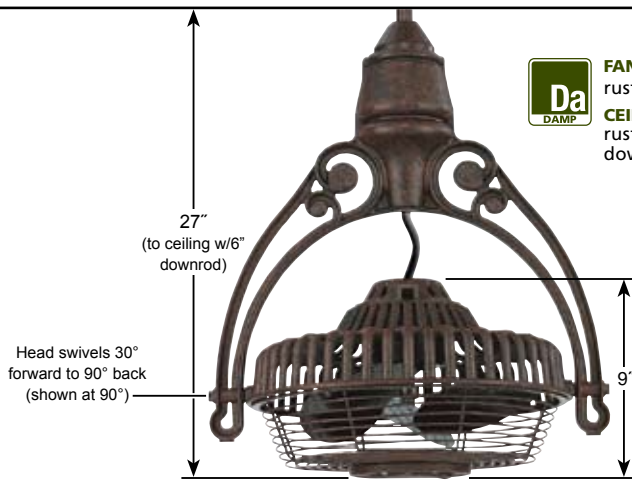

FAN: FPH210RS (1)
rust motor assembly
CEILING MOUNT: FPH81RS (1)
rust ceiling mount—1" dia. x 6" long
downrod included



FAN: FPH210BL (1)
black motor assembly
BASE: FPH41BL (1)
black floor/desk base



FAN: FPH210PW (1)
pewter motor assembly
BASE: FPH21BL (1)
black pedestal base
COLUMN: FPH70CW (1)
cane wrapped column

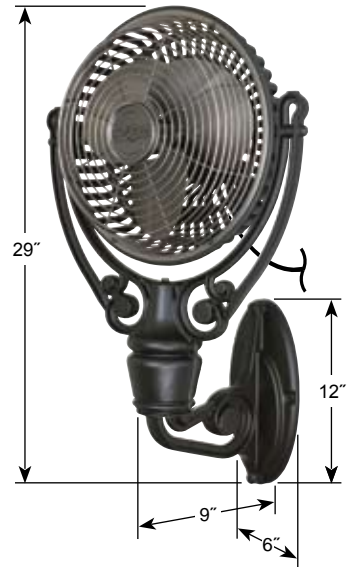

FAN: FPH210PW (1)
pewter motor assembly
WALL MOUNT: FPH61BL (1)
black wall mount

CUSTOM COLUMNS

- Required with pedestal base mount
- FPH70BL is damp location rated



FPH70BL
Black



FPH70CP
Carved post



FPH70CW
Cane wrapped

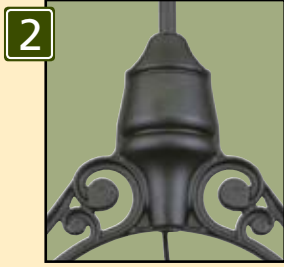

Select a mounting system

Choose a **ceiling mount**
 Select from black or rust
 6" downrod included



or Choose a **desk/floor mount**
 Select from black or rust



or Choose a **pedestal mount with a custom column**
 Select from black or rust
 pedestal bases
 Select from black, cane wrapped or carved post columns



or Choose a **wall mount**
 Select from black or rust



Da **FAN: FPH210AC (1)**
 antique copper and black motor assembly
CEILING MOUNT: FPH81BL1 (1)
 black ceiling mount—1" dia. x 6" long
 downrod included



Dr **FAN: FPH210PW (1)**
 pewter and black motor assembly
BASE: FPH21BL (1)
 black pedestal base
COLUMN: FPH70BL (1)
 black column



FAN: FPS7840VZ (1)
venetian bronze assembly with
amber swirl glass and reversible
dark cherry/teak wood blades
■ dark cherry side showing



FAN: FPS7840VZ (1)
venetian bronze assembly with
amber swirl glass and reversible
dark cherry/teak wood blades
■ dark cherry side showing



FAN: FPS7840SB (1)
sedona beige assembly with
amber swirl glass and reversible
dark cherry/teak wood blades
■ dark cherry side showing

THE LORETO BAY™

SNUGGER FAN
MOUNTS FLUSH TO CEILING

TROPICAL BREEZES

ENERGY INFORMATION

at High Speed

Airflow	Electricity Use	Airflow Efficiency
5602 Cubic Feet Per Minute	73 Watts (excluding lights)	77 Cubic Feet Per Minute Per Watt

UNIPACKED
CONTROL & BLADES INCLUDED

LIMITED LIFETIME MOTOR WARRANTY

BUILT-IN DOWNLIGHT

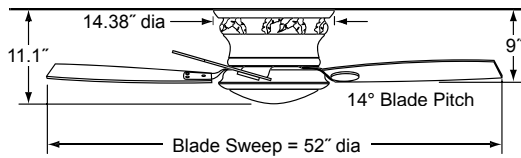

Finishes (swatches on page 132):

SB fan | dark cherry/teak reversible blade | amber swirl glass
VZ fan | dark cherry/teak reversible blade | amber swirl glass

Blades:

19" blade set included (see finish above)

Motor:

188 x 20

Speeds:

3 forward and 3 reverse (reversing switch on remote)

Controls:

TR20WH hand-held remote with wall mount
Optional controls available (p.128-131)

Lighting:

3 40-watt candelabra bulbs included

Downrod:

Fan mounts flush to ceiling and does not require use of a downrod

Location Use:

Dry location rated only

Net Hanging Weight:

24.8 lbs.

Patents Pending

UL LISTED

OPTIONS



THE LORETO BAY™



FAN: FPS7840VZ (1)
venetian bronze assembly with amber swirl glass and reversible dark cherry/teak wood blades
■ teak side showing



REMOTE & WALL MOUNT INCLUDED:

TR20WH

- Fan and light control
- Mounts over switch plate
- 3 speed reversing
- Infinite light levels





Dr
DRY ONLY

FAN: MAD3260B (1)
oil-rubbed bronze assembly

BLADES: B5260WA (1)
22" walnut concave ribbed carved wood

2 35W
UPPER

1 100W
LOWER INCLUDED



FAN: MAD3260RS (1)
rust assembly

BLADES: B5260WA (1)
22" walnut concave ribbed carved wood

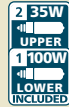

FAN: MAD3260AB (1)
antique brass assembly

BLADES: ISP1 (1)
22" natural palm leaf wide oval



SANDELLA®

LIGHT UP THE TROPICS

ENERGY INFORMATION

at High Speed

Airflow	Electricity Use	Airflow Efficiency
5580 Cubic Feet Per Minute	32 Watts (excluding lights)	174 Cubic Feet Per Minute Per Watt

MULTICOMPONENT
MOTOR & BLADES

LIMITED LIFETIME MOTOR WARRANTY

BUILT-IN DOWNLIGHT

DECORATIVE UPLIGHT

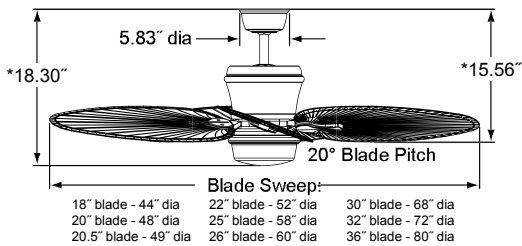

*With included 6" downrod

Finishes (swatches on page 132):

AB Dry location only
BA Dry location only
OB Dry and damp locations
SN Dry and damp locations
RS Dry and damp locations

Downrod:

1" dia. x 6" long downrod included
Longer lengths available—p.132

Ceiling slope:

Up to 30° (52° with SCB1-52)

Location Use:

See finishes
(please note location rating of selected blades)

Net Hanging Weight:

15.65 lbs.

ETL LISTED

Blades:

Sold separately (pages 134-137)

Motor:

DC - 1255

Speeds:

6 forward and 6 reverse (switch on remote)

Controls:

TR31 hand-held remote
Optional TW32 Wall Control available (p.128-131)

Lighting:

One 100-watt halogen minican downlight bulb included
Two 35-watt halogen minican uplight bulbs included

OPTIONS



SANDELLA®

DC motor
CONSUMES UP TO 70% LESS ENERGY



FAN: MAD3260SN (1)

satin nickel assembly



BLADES: B6000TK (1)

36" teak curved wood



REMOTE INCLUDED:



TR31

- Fan and light control
- Uplight and downlight
- 6 speed reversing
- Infinite light levels

EASY ORDERING STEPS:



Select a motor

Available finishes listed above

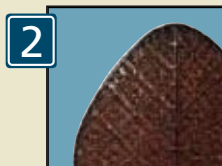

Select a blade set

(pages 134-137)



Optional lighting & accessories

(page 124-127, 132-133)



Wall controls

(pages 128-131)

SANDELLA®



FAN: MAD3260RS (1)
rust assembly



BLADES: BPW5240RS (1)
natural finish all-weather
composite Chinese palm
with rust blade arm



FAN: MAD3260BA (1)
bronze accent assembly



BLADES: ISD1A (1)
22" antique wide oval
woven bamboo

ENERGY INFORMATION

at High Speed

Airflow	Electricity Use	Airflow Efficiency
5580	32	174
Cubic Feet Per Minute	Watts (excluding lights)	Cubic Feet Per Minute Per Watt



FAN: MAD3260OB (1)
oil-rubbed bronze assembly
BLADES: B5270WA (1)
22" walnut concave carved
wood with woven bamboo
inlay



FAN: MAD3260AB (1)
antique brass assembly
BLADES: B5280WA (1)
22" walnut wide oval leaf
carved wood



FAN: MAD326ORS (1)
rust assembly
BLADES: B6110WA (1)
26" walnut raised
contour carved wood



FAN: MAD3250RS (1)
rust assembly
BLADES: ISD4A (1)
22" antique narrow
oval woven bamboo



FAN: MAD3250RS (1)
rust assembly



BLADES: ISD4A (1)
22" antique narrow oval
woven bamboo



LIGHT KIT: LKLP101RS (1)
rust low-profile with
white frosted glass



FAN: MAD3250AB (1)
antique brass assembly



BLADES: ISP1 (1)
22" natural palm leaf wide oval

FITTER: F423AB (1)
antique brass bowl fitter

GLASS: G439 (1)
hand-painted parrot bowl

THE ISLANDER[®]

A TOUCH OF THE TROPICS



ENERGY INFORMATION

at High Speed

Airflow	Electricity Use	Airflow Efficiency
5580	32	174
Cubic Feet Per Minute	Watts (excluding lights)	Cubic Feet Per Minute Per Watt

MULTICOMPONENT
MOTOR & BLADES

LIMITED LIFETIME MOTOR WARRANTY

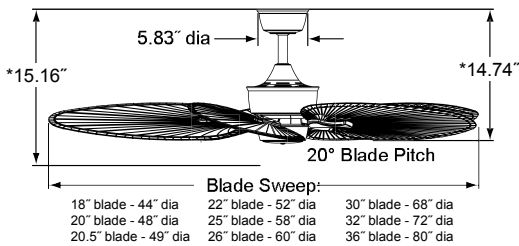

*With included 6" downrod

Finishes (swatches on page 132):

AB	Dry location only
BA	Dry location only
OB	Dry and damp locations
PW	Dry location only
RS	Dry and damp locations

Blades:

Sold separately (pages 134-137)

Motor:

DC - 125S

Speeds:

6 forward and 6 reverse (reversing switch on remote)

Controls:

TR29 hand-held remote
Optional TW30 Wall Control available (p.128-131)

Lighting:

Accepts standard fitters and light kits—sold separately (pages 124-127)

Downrod:

1" dia. x 6" long downrod included
Longer lengths available—p.132
Close-to-ceiling kit available—p.133
Note: use of close-to-ceiling kit with this fan requires complete removal of fan if receiver replacement is necessary

Ceiling slope

Up to 30° (52° with SCB1-52)

Location Use:

See finishes
(please note location rating of selected blades)

Net Hanging Weight:

14.04 lbs.

UL LISTED

OPTIONS

124-127

LIGHTING

128-131

CONTROLS

134-137

BLADES

Da

DAMP

THE ISLANDER[®]

DC motor
CONSUMES UP TO 70% LESS ENERGY



REMOTE INCLUDED:



TR29

- Fan and light control
- Downlight
- 6 speed reversing
- Infinite light levels



FAN: MAD32500B (1)
oil-rubbed bronze assembly

BLADES: B5300WA (1)
32" walnut oval leaf carved wood

CLOSE-TO-CEILING KIT: CCK80020B (1)
oil-rubbed bronze close-to-ceiling kit (sold separately)

EASY ORDERING STEPS:



Select a motor

Available finishes listed above



Select a blade set

(pages 134-137)



Optional lighting & accessories

(page 124-127, 132-133)



Wall controls

(pages 128-131)

THE ISLANDER[®]



FAN: MAD3250BA (1)
bronze accent assembly



BLADES: B5280WA (1)
22" walnut wide oval leaf
carved wood

LIGHT KIT: LK114ABA (1)
14" bronze accent low-profile
with amber linen glass bowl

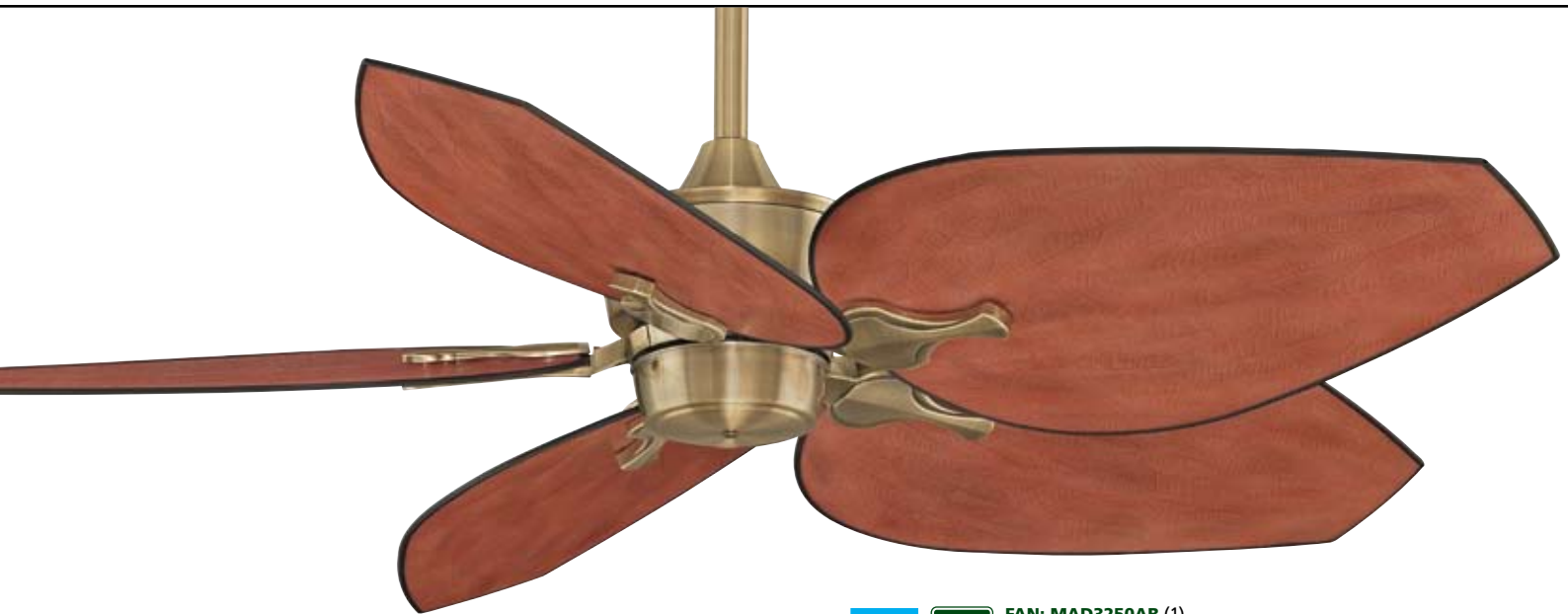

FAN: MAD3250AB (1)
antique brass assembly

BLADES: BPW5290DM (1)
22" all-weather composite
dark mango leaf

ENERGY INFORMATION

at High Speed

Airflow Cubic Feet Per Minute	Electricity Use 32 Watts (excluding lights)	Airflow Efficiency 174 Cubic Feet Per Minute Per Watt
5580	32	174

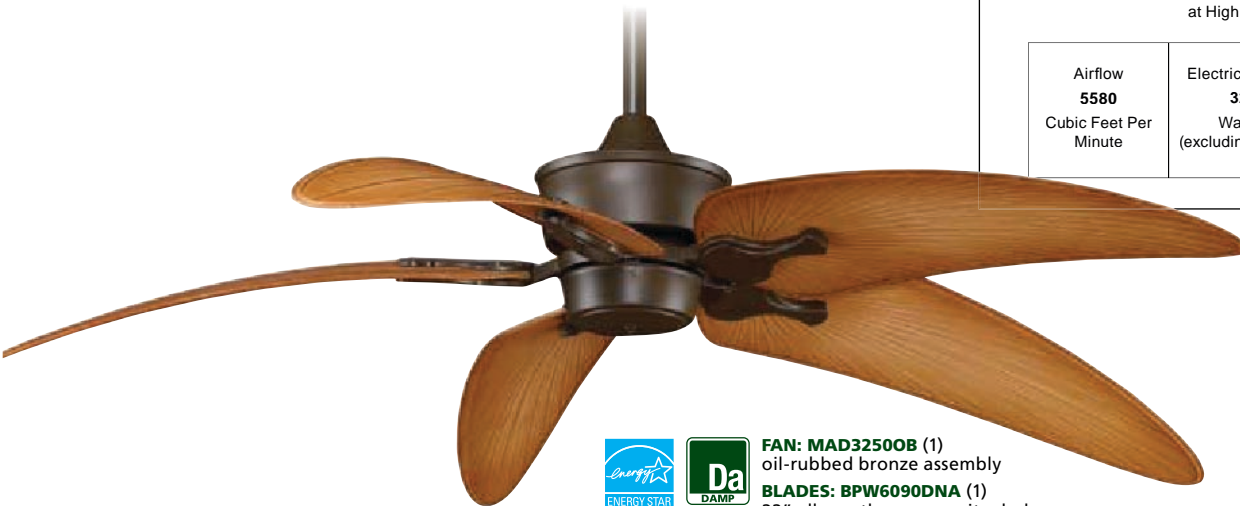

FAN: MAD3250OB (1)
oil-rubbed bronze assembly
BLADES: BPW6090DNA (1)
22" all-weather composite dark
natural accent narrow palm

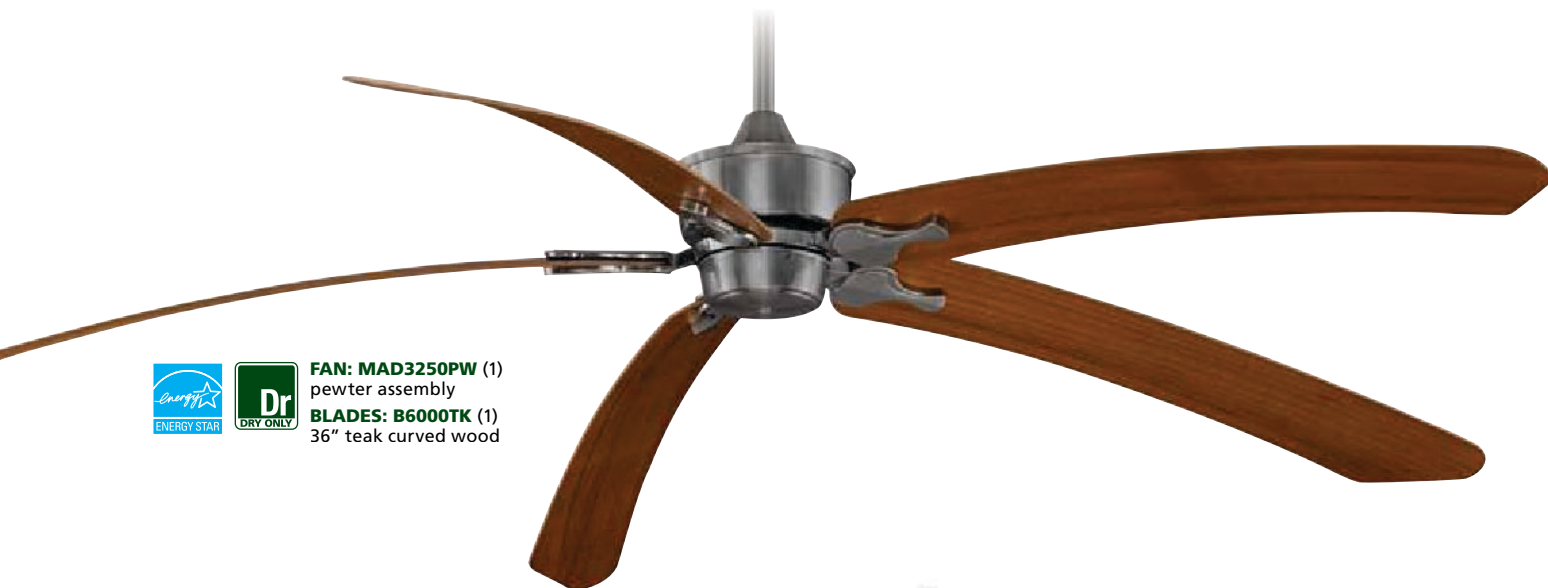

FAN: MAD3250PW (1)
pewter assembly
BLADES: B6000TK (1)
36" teak curved wood



FAN: MAD3250RS (1)
rust assembly
BLADES: ISD1A (1)
22" antique wide oval
woven bamboo



FITTER: F423RS (1)
rust bowl fitter
GLASS: G450 (1)
amber bowl



FAN: MAD325PW (1)
pewter assembly
BLADES: B5330WA (1)
22" walnut soft
rounded carved wood



FAN: MAD3255RS (1)
rust assembly
BLADES: BPW6090DNA (1)
22" all-weather composite dark
natural accent narrow palm



FAN: MAD3255BA (1)
bronze accent assembly
BLADES: ISP4 (1)
22" natural narrow oval palm

LOUVRE®



CONTEMPORARY. DYNAMIC. PLAYFUL.

ENERGY INFORMATION

at High Speed

Airflow	Electricity Use	Airflow Efficiency
5580	32	174
Cubic Feet Per Minute	Watts (excluding lights)	Cubic Feet Per Minute Per Watt

MULTICOMPONENT
MOTOR & BLADES

LIMITED LIFETIME MOTOR WARRANTY

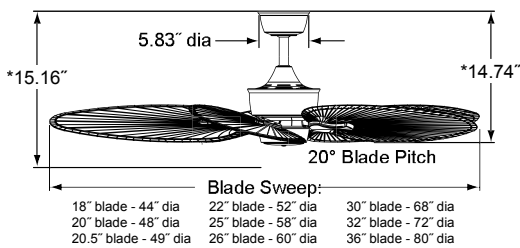

*With included 6" downrod

Finishes (swatches on page 132):

- BA Dry location only
- PW Dry location only
- RS Dry and damp locations

Blades:

Sold separately (pages 134-137)

Motor:

DC - 125S

Speeds:

6 forward and 6 reverse (reversing switch on remote)

Controls:

TR29 hand-held remote
Optional TW30 Wall Control available (p.122-125)

Lighting:

Accepts standard fitters and light kits—sold separately (pages 124-127)

Downrod:

1" dia. x 6" long downrod included
Longer lengths available—p.132
Close-to-ceiling kit available—p.133
Note: use of close-to-ceiling kit with this fan requires complete removal of fan if receiver replacement is necessary

Ceiling slope:

Up to 30° (52° with SCB1-52)

Location Use:

Dry and damp location rated (please note location rating of selected blades)

Net Hanging Weight:

14.93 lbs.

UL LISTED

OPTIONS



LOUVRE®

DC motor
CONSUMES UP TO 70% LESS ENERGY

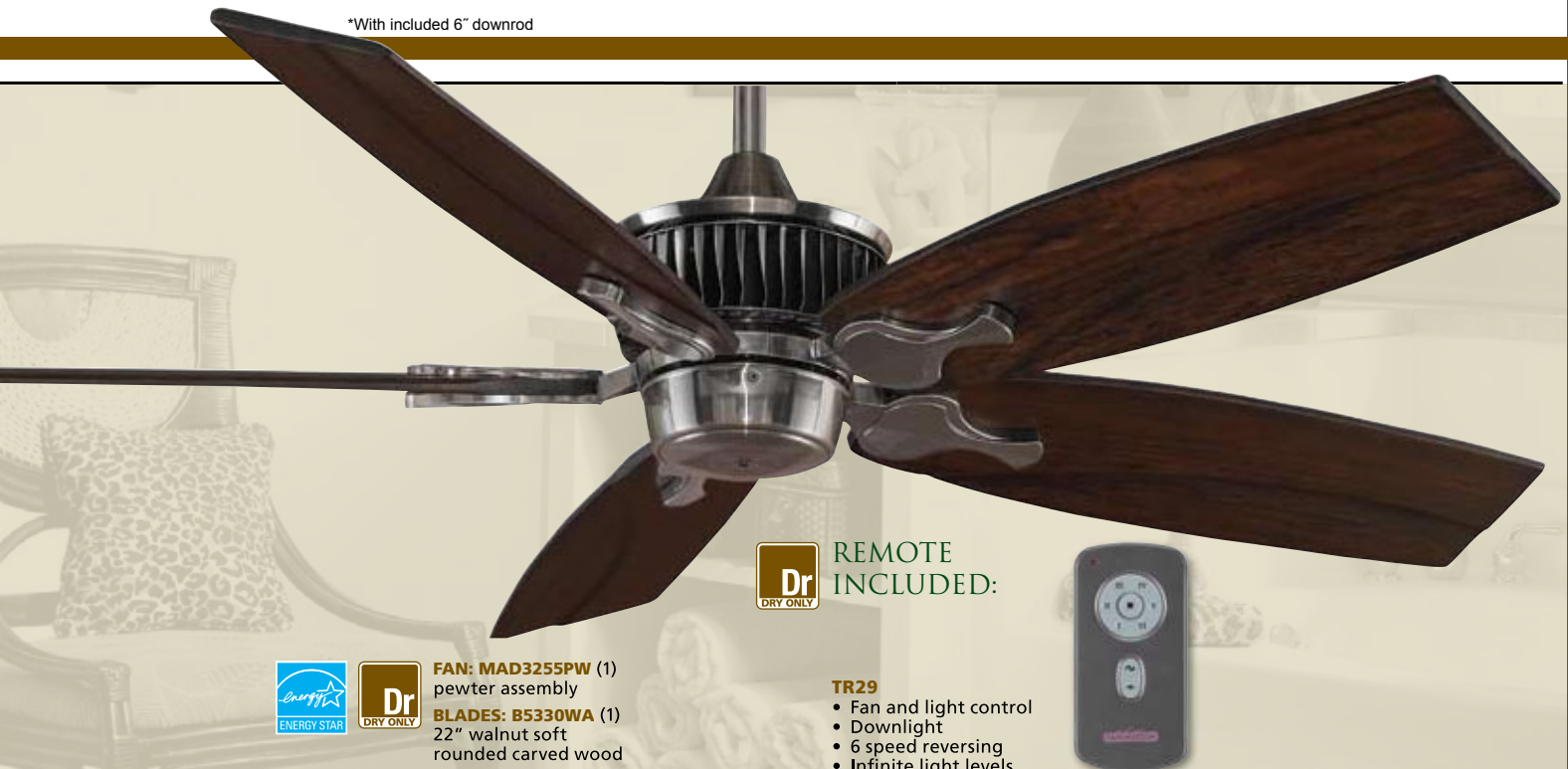

REMOTE INCLUDED:



TR29

- Fan and light control
- Downlight
- 6 speed reversing
- Infinite light levels



FAN: MAD325PW (1)
pewter assembly

BLADES: B5330WA (1)
22" walnut soft rounded carved wood

EASY ORDERING STEPS:



Select a motor

Available finishes listed above



Select a blade set

(pages 134-137)



Optional lighting & accessories

(page 124-127, 132-133)



Wall controls

(pages 128-131)

LOUVRE®



FAN: MAD3255RS (1)
rust assembly



BLADES: B5330WA (1)
22" walnut soft rounded carved
wood blade

LIGHT KIT: LK113WH (1)
14" white fabric drum lamp shade



FAN: MAD3255RS (1)
rust assembly

BLADES: BPW5240RS (1)
natural finish all-weather
composite Chinese palm
with rust blade arm

ENERGY INFORMATION

at High Speed

Airflow	Electricity Use	Airflow Efficiency
5580	32	174
Cubic Feet Per Minute	Watts (excluding lights)	Cubic Feet Per Minute Per Watt



FAN: MAD3255BA (1)
bronze accent assembly

BLADES: B6030CY (1)
30" cherry curved wood blades

LIGHT KIT: LKLP111ABA (1)
bronze accent low-profile with amber
linen glass

CLOSE-TO-CEILING KIT: CCK8002BA (1)
bronze accent close-to-ceiling kit
(sold separately)



FAN: MAD3250PW (1)
pewter assembly

BLADES: ISD4A (1)
22" antique narrow oval
woven bamboo blades



FAN: MAD3255BA (1)
bronze accent assembly

BLADES: ISP1 (1)
22" natural palm wide oval



FAN: FP4320LT1 (2)
latte assembly
BLADES: BPD4A (2)
22" all-weather composite antique
woven bamboo narrow oval

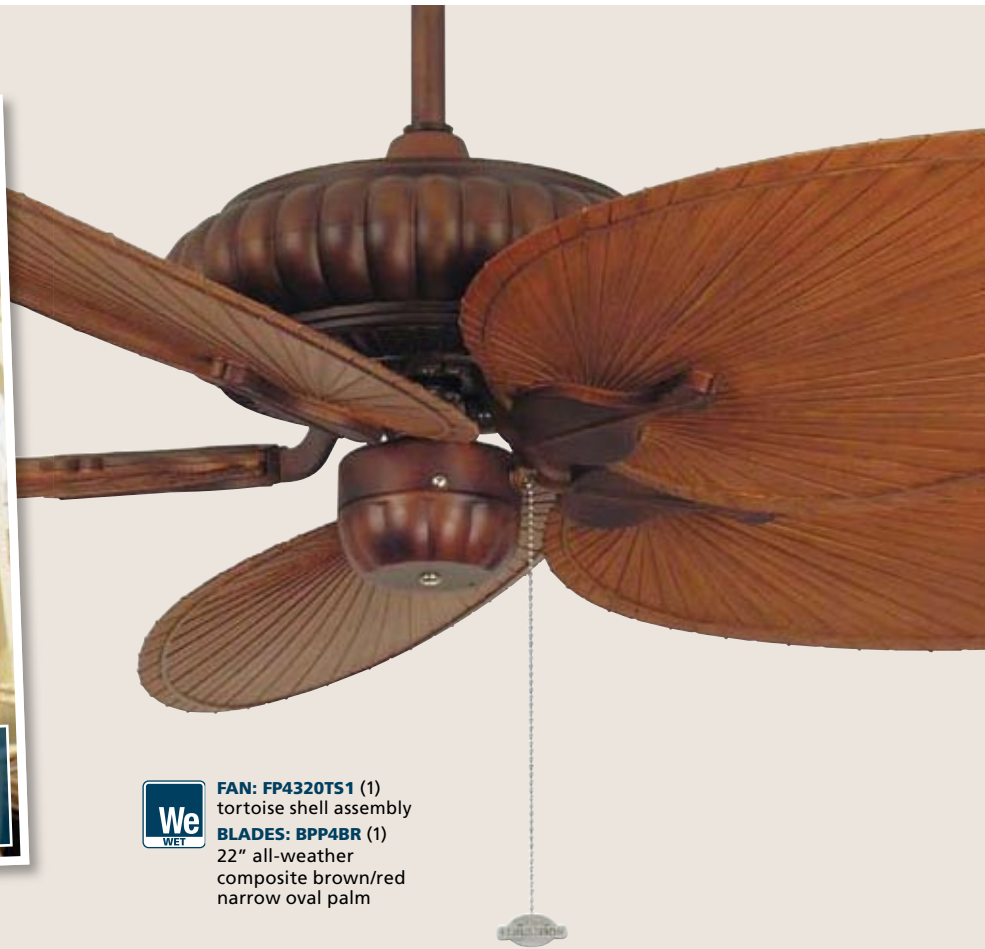

FAN: FP4320TS1 (1)
tortoise shell assembly
BLADES: BPP4BR (1)
22" all-weather
composite brown/red
narrow oval palm



FAN: FP4320AZ1 (1)
aged bronze assembly
BLADES: BPW6090DNA (1)
22" all-weather composite dark
natural accent narrow palm

THE BELLERIA®

BALMY BREEZES—RAIN OR SHINE

ENERGY INFORMATION

at High Speed

Airflow	Electricity Use	Airflow Efficiency
5580	83	67
Cubic Feet Per Minute	Watts (excluding lights)	Cubic Feet Per Minute Per Watt

MULTICOMPONENT
MOTOR & BLADES

LIMITED LIFETIME MOTOR WARRANTY

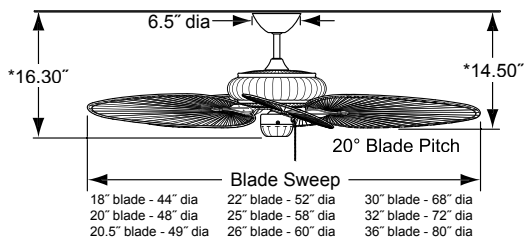

*With included 6" downrod

Finishes (swatches on page 132):

AZ Wet location
LT Wet location
MW Wet location
TB Wet location
TS Wet location

Blades:

Sold separately (pages 134-137); can use wet location blade sets or traditional blade sets

Motor:

188 x 25

Speeds:

3 forward and 3 reverse (reversing switch on switch cup)

Controls:

Optional controls available (p.128-131)

Lighting:

Accepts standard fitters and light kits—sold separately (pages 124-127)

Downrod:

1" dia. x 6" long downrod included
Longer lengths available—p.132
Close-to-ceiling kit available—p.133

Ceiling slope:

Up to 30° (52° with SCB1-52)

Location Use:

Fan rated for dry, damp and wet locations (please note location rating of selected blades)

Net Hanging Weight:

25.0 lbs.

U.S. Pat # D 518, 166

UL LISTED

OPTIONS



THE BELLERIA®



FAN: FP4320AZ1 (1)
aged bronze assembly

BLADES: BPD4A (1)
22" all-weather composite antique woven bamboo narrow oval

EASY ORDERING STEPS:



1

Select a motor

Available finishes listed above

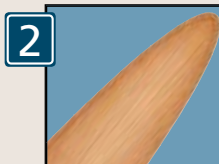

2

Select a blade set

(pages 134-137)



3

Optional lighting & accessories

(page 124-127, 132-133)



4

Optional remote and wall controls

(pages 128-131)

THE BELLERIA®



FAN: FP4320LT1 (1)
latte assembly



BLADES: BPD4BL (1)
22" all-weather composite black
woven bamboo narrow oval

FITTER: FW423LT (1)
latte wet location bowl fitter

GLASS: G422 (1)
clear/frosted mosaic glass bowl



FAN: FP4320MW1 (1)
matte white assembly

BLADES: BPW10CY (1)
20.5" all-weather
composite cherry

ENERGY INFORMATION

at High Speed

Airflow Cubic Feet Per Minute	Electricity Use 83 Watts (excluding lights)	Airflow Efficiency 67 Cubic Feet Per Minute Per Watt
5580	83	67



FAN: FP4320TS1 (1)
tortoise shell assembly
BLADES: BPW5290DM (1)
22" all-weather composite
dark mango leaf

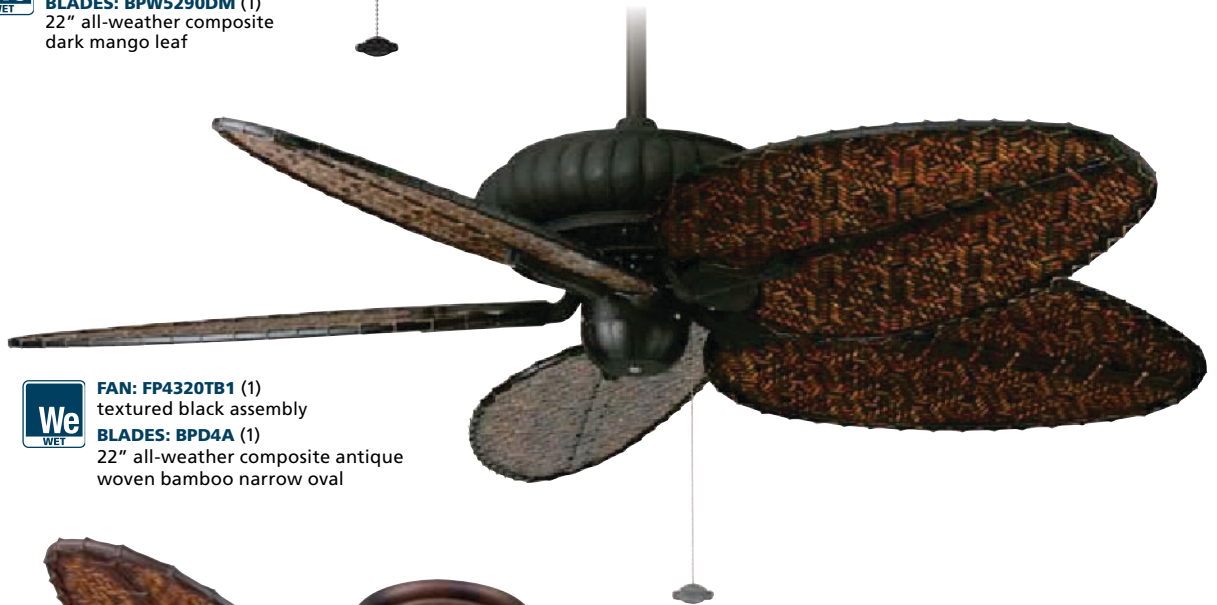

FAN: FP4320TB1 (1)
textured black assembly
BLADES: BPD4A (1)
22" all-weather composite antique
woven bamboo narrow oval



FAN: FP4320TS1 (1)
tortoise shell assembly
BLADES: BPD4A (1)
22" all-weather composite antique
woven bamboo narrow oval
CLOSE-TO-CEILING KIT: CCK8002TS (1)
bronze accent close-to-ceiling kit
(sold separately)
LIGHT KIT: LKLP101TS (1)
tortoise shell low-profile with white
frosted glass





We
WET

FAN: FP920AZ (1)
aged bronze assembly
BLADE SET: BPP4TN (1)
22" all-weather composite
natural finish narrow oval palm



Dr
DRY ONLY

FAN: FP920AZ (1)
aged bronze fan
BLADE SET: ISP4 (1)
22" natural palm narrow oval
ACCESSORY: TA92AZ (1)
aged bronze table accessory

THE TORRENTO®

A FAN FOR ALL SEASONS

MULTICOMPONENT
MOTOR & BLADES

LIMITED LIFETIME MOTOR WARRANTY

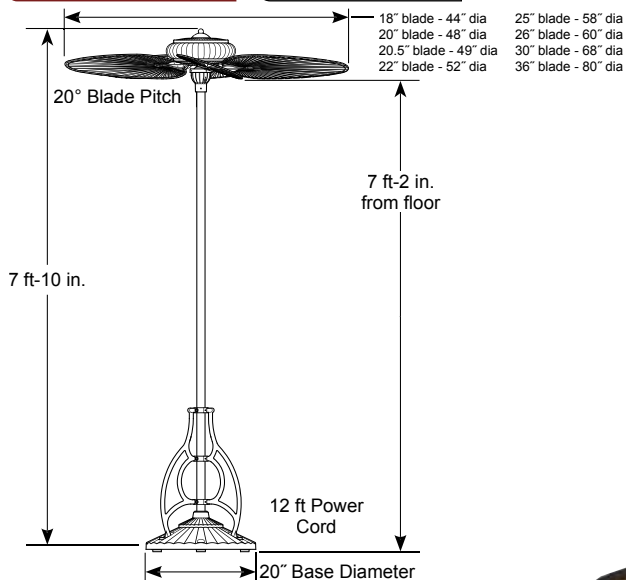

Finishes (swatches on page 132):
AZ fan

Weight:
75 lbs.

Blades:
Sold separately (pages 134-137)

Location Use:
Dry, damp and wet location rated

Motor Housing:
All-weather composite with aluminum shaft and base

U.S. Pat # D 513, 800
U.S. Pat # D 518, 166

Motor:
188 x 25

UL LISTED

Speeds:
3 forward and 3 reverse (reversing switch on motor housing)

Base must be secured to wood or concrete floor (hardware included)

Features:
12' power cord included

OPTIONS



THE TORRENTO®



FAN: FP920AZ (1)
aged bronze fan
BLADE SET: BPD4A (1)
22" all-weather composite antique woven bamboo narrow oval

EASY ORDERING STEPS:



1 Order your fan assembly



2 Select a blade set
(pages 134-137)

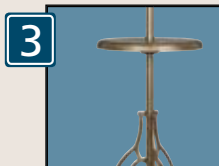

3 Optional table accessory
Select from aged bronze, TA920AZ or textured black, TA920TB



FAN: FP7500AB (1)
antique brass assembly
with 22" natural palm
leaf narrow oval blades



LIGHT KIT: LKLP102AB (1)
antique brass low-profile
with white frosted glass



FAN: FP7500AB (1)
antique brass assembly
with 22" natural palm
leaf narrow oval blades

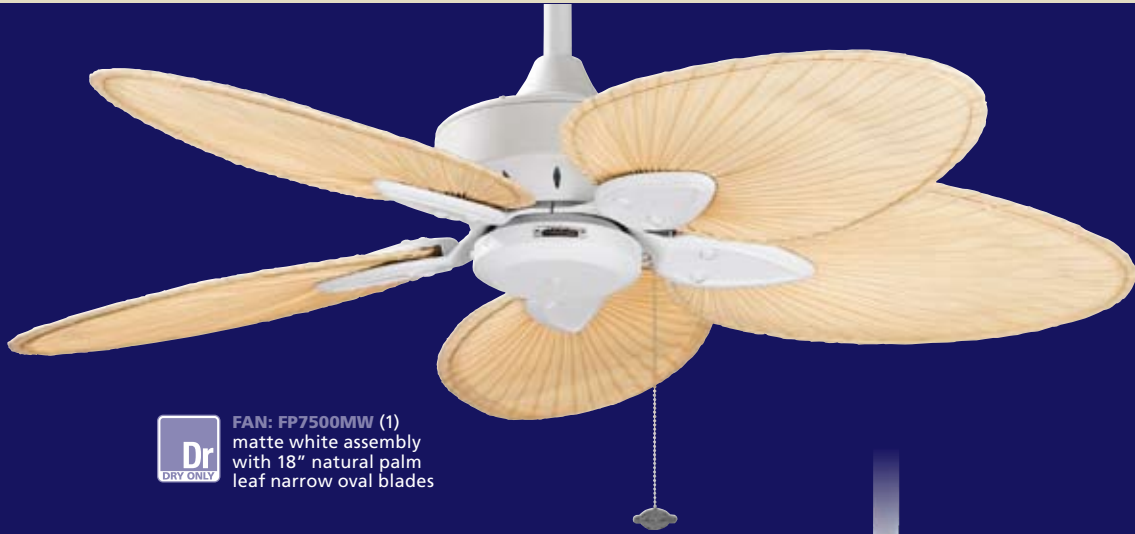

FAN: FP7500MW (1)
matte white assembly
with 18" natural palm
leaf narrow oval blades



FAN: FP7510MW (1)
matte white assembly with
22" all-weather composite
matte white blades

THE WINDPOINTE®

FIVE-BLADE SERIES FANS

UNIPACKED

ENERGY INFORMATION

at High Speed

	Airflow	Electricity Use	Airflow Efficiency
FP7500AB:	2633	42	63
FP7500MW:	2812	42	67
FP7510MW:	5483	70	78
FP7500RS:	2551	42	60
	Cubic Feet Per Minute	Watts (excluding lights)	Cubic Feet Per Minute Per Watt

UNIPACKED
BLADES INCLUDED

LIMITED LIFETIME MOTOR WARRANTY

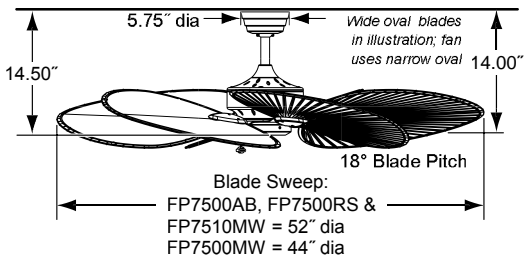

*With included 6" downrod

Finishes (swatches on page 132):

FP7500AB —AB fan | natural palm
 FP7500MW —MW fan | natural palm
 FP7500RS —RS fan | antique bamboo
 FP7510MW —MW fan | MW composite

Blades:

22" blade set included, except
 FP7500MW—18" blade set included (see finish above)

Motor:

188 x 25

Speeds:

3 forward and 3 reverse (reversing switch on switch cup)

Controls:

Optional controls available (p.128-131)

Lighting:

Accepts standard fitters and light kits—sold separately (pages 124-127)

Downrod:

1" dia. x 6" long downrod included
 Longer lengths available—p.132
 Close-to-ceiling kit available—p.133

Ceiling slope

Up to 30° (52° with SCB1-52)

Location Use:

FP7500AB is dry location rated only
 FP7500MW is dry location rated only
 FP7500RS is dry and damp location rated
 FP7510MW is dry and damp location rated

Net Hanging Weight:

FP7500AB = 23.84 lbs
 FP7500MW = 23.66 lbs
 FP7500RS = 25.41 lbs
 FP7510MW = 20.86 lbs

UL LISTED

OPTIONS



THE WINDPOINTE®



FAN: FP7500RS (1)
 rust assembly with five 22"
 antique narrow oval woven
 bamboo



LIGHT KIT: LK114ARS (1)
 14" rust low-profile with
 amber linen glass bowl



FAN: FP7500AB (1)
 antique brass assembly with 22"
 natural palm leaf narrow oval blades



FITTER: F423AB (1)
 antique brass bowl fitter

GLASS: G439 (1)
 hand-painted parrot bowl





Dr
DRY ONLY

3 60W
INCLUDED

FAN: FP7410OB (1)
oil-rubbed bronze assembly with
four cairo purple carved wood blades
FITTER: F423OB (1)
oil-rubbed bronze bowl fitter
SHADE: S480 (1)
beige brocade fabric shade



Da
DAMP

FAN: FP7300RS (1)
rust assembly with three
dark brown/red tight
weave blades



Dr
DRY ONLY

FAN: FP7410AB (1)
antique brass assembly
with sambel sand carved
wood blades

THE WINDPOINTE®

THREE- AND FOUR-BLADE SERIES FANS

UNIPACKED



ENERGY INFORMATION

at High Speed

Airflow	Electricity Use	Airflow Efficiency
FP7300RS: 4087	54	76
FP7410AB: 4240	50	86
FP7410OB: 5129	49	104
Cubic Feet Per Minute	Watts (excluding lights)	Cubic Feet Per Minute Per Watt

UNIPACKED
BLADES INCLUDED

LIMITED LIFETIME MOTOR WARRANTY

Finishes (swatches on page 132):

FP7300RS —RS fan | dark brown/red tight weave
 FP7410AB —AB fan | sambel sand carved wood
 FP7410OB —OB fan | cairo purple carved wood

Blades:

22" blade set included, except FP7300RS—24" blade set included (see finish above)

Motor:

188 x 25

Speeds:

3 forward and 3 reverse (reversing switch on switch cup)

Controls:

Optional controls available (p.128-131)

Lighting:

Accepts standard fitters and light kits—sold separately (pages 124-127)

Downrod:

1" dia. x 6" long downrod included
 Longer lengths available—p.132
 Close-to-ceiling kit available—p.133

Ceiling slope

Up to 30° (52° with SCB1-52)

Location Use:

Dry location rated only

Net Hanging Weight:

26.5 lbs.

UL LISTED

OPTIONS



THE WINDPOINTE®

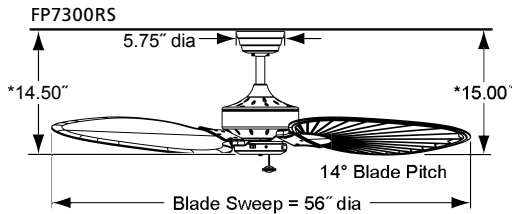

*With included 6" downrod

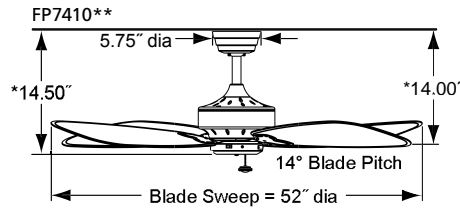

FAN: FP7410OB (1)
 oil-rubbed bronze assembly
 with four cairo purple
 carved wood blades



FAN: MA7500OB (1)
oil-rubbed bronze assembly

BLADES: BPW20MH (1)
20" mahogany all-weather



CLOSE-TO-CEILING KIT: CCK8002OB (1)
oil-rubbed bronze close-to-ceiling
kit (sold separately)

LIGHT KIT: LKLP102OB (1)
oil-rubbed bronze low-profile with
white frosted glass

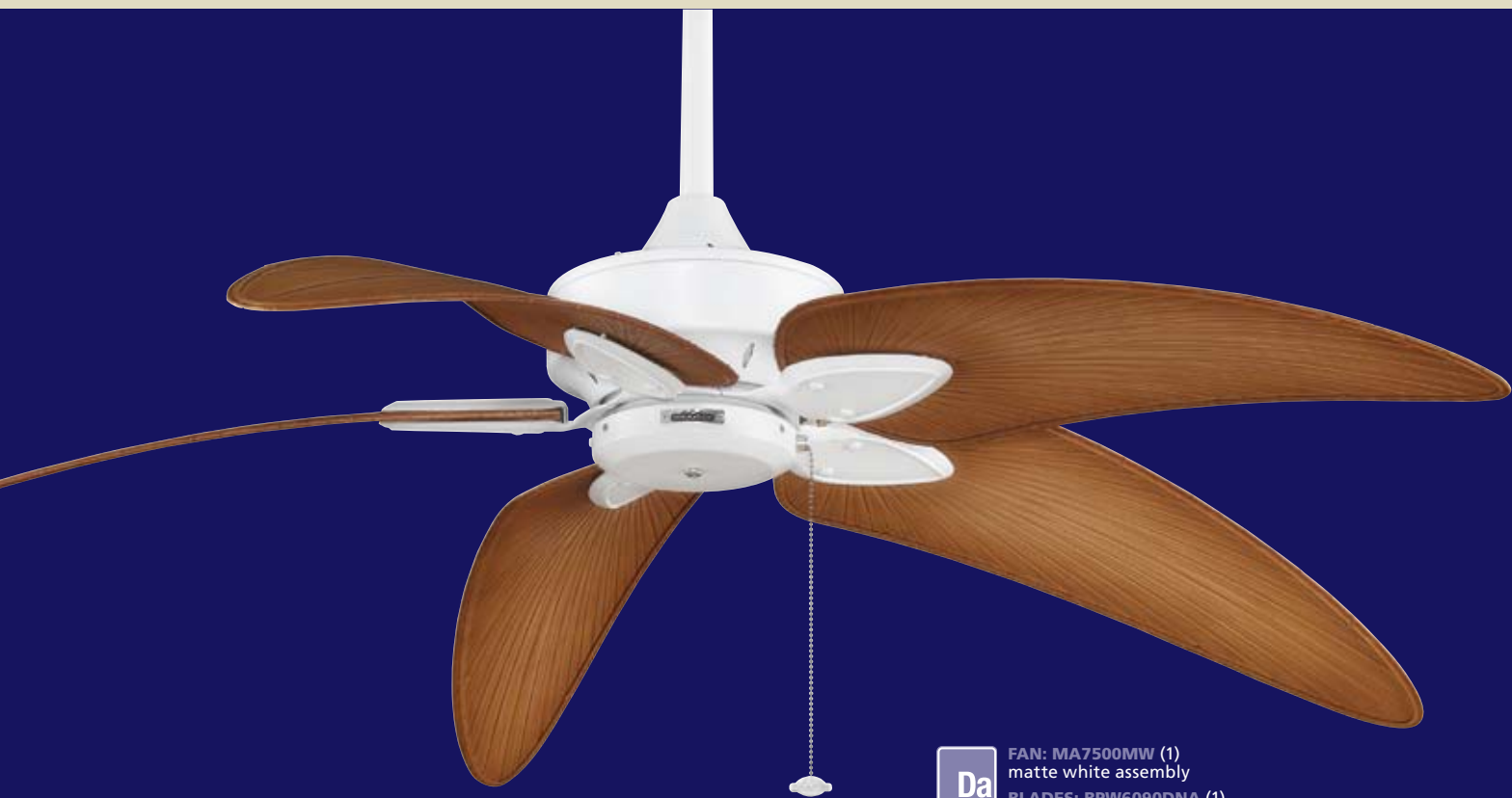

FAN: MA7500MW (1)
matte white assembly

BLADES: BPW6090DNA (1)
22" all-weather composite dark
natural accent narrow palm

THE WINDPOINTE®

FIVE-BLADE FANS CUSTOM

ENERGY INFORMATION

at High Speed

Airflow	Electricity Use	Airflow Efficiency
4987 Cubic Feet Per Minute	49 Watts (excluding lights)	102 Cubic Feet Per Minute Per Watt

MULTICOMPONENT
MOTOR & BLADES

LIMITED LIFETIME MOTOR WARRANTY

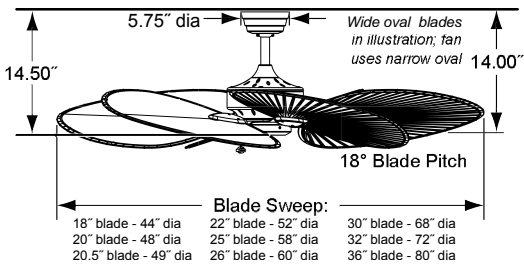

*With included 6" downrod

Finishes (swatches on page 132):

AB	Dry location only
MW	Dry and damp locations
OB	Dry and damp locations
PW	Dry location only
RS	Dry and damp locations

Blades:

Sold separately (pages 134-137)

Motor:

188 x 25

Speeds:

3 forward and 3 reverse (switch on switch cup)

Controls:

Optional controls available (p.128-131)

Lighting:

Accepts standard fitters and light kits—sold separately (pages 124-127)

Downrod:

1" dia. x 6" long downrod included
Longer lengths available—p.132
Close-to-ceiling kit available—p.133

Ceiling slope

Up to 30° (52° with SCB1-52)

Location Use:

See finishes
(please note location rating of selected blades)

Net Hanging Weight:

24.87 lbs.

UL LISTED

OPTIONS



THE WINDPOINTE®



FAN: MA7500RS (1)
rust assembly

BLADES: B5280WA (1)
22" walnut wide oval
leaf carved wood

EASY ORDERING STEPS:



1

Select a motor

Available finishes listed above

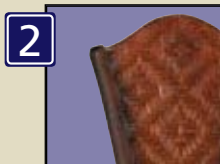

2

Select a blade set

(pages 134-137)



3

Optional lighting & accessories

(page 124-127, 132-133)



4

Optional remote and wall controls

(pages 128-131)

THE WINDPOINTE®



FAN: MA7500RS (1)
rust assembly



BLADES: BPW20MH (1)
20" mahogany all-weather

LIGHT KIT: LK500RS (1)
rust modern frosted
three-glass light kit

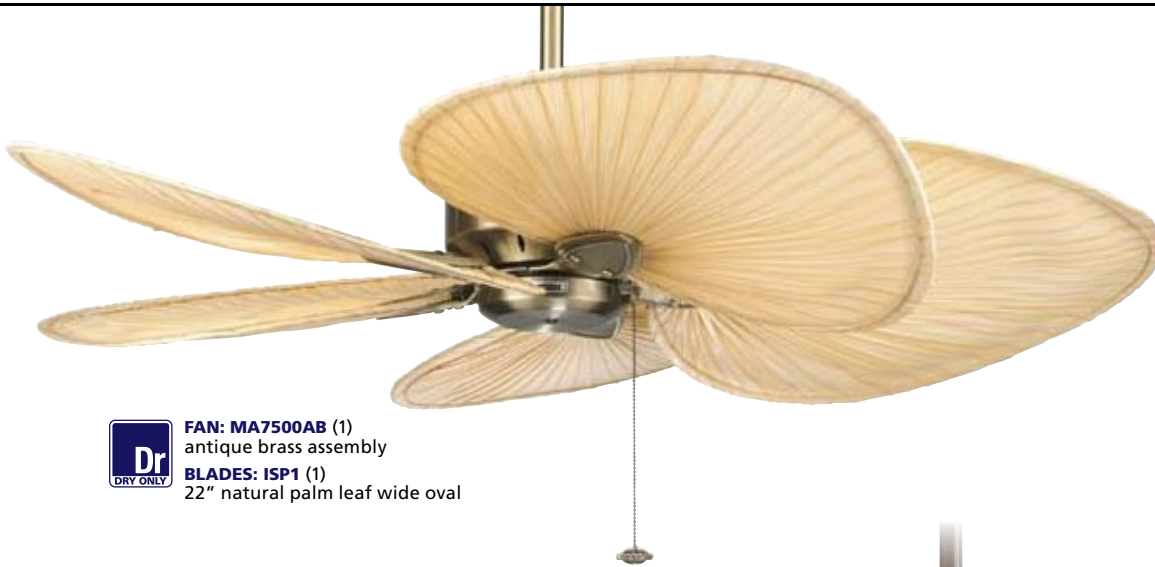

FAN: MA7500AB (1)
antique brass assembly

BLADES: ISP1 (1)
22" natural palm leaf wide oval

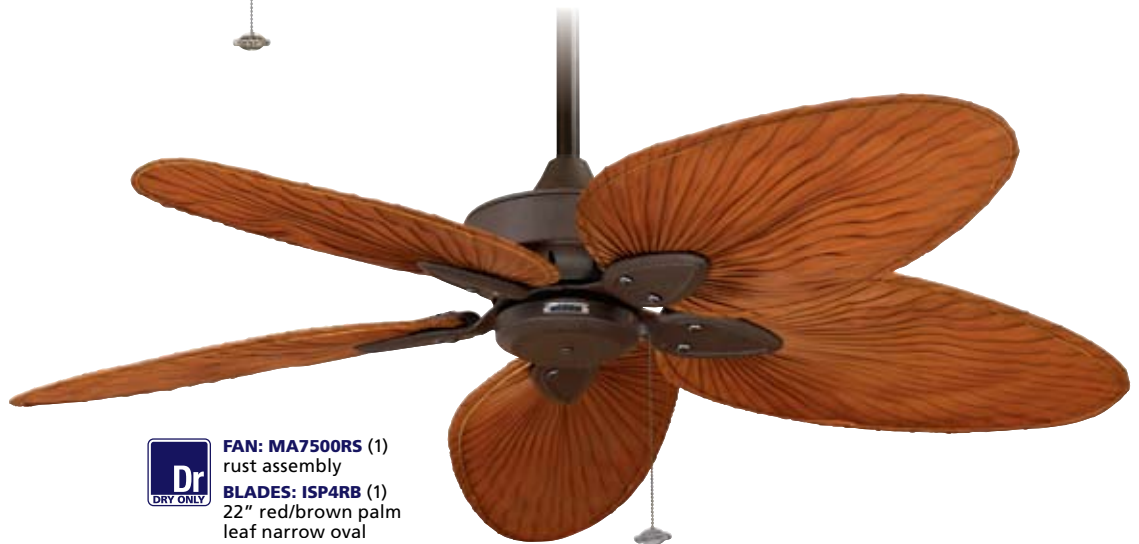

FAN: MA7500RS (1)
rust assembly

BLADES: ISP4RB (1)
22" red/brown palm
leaf narrow oval

ENERGY INFORMATION

at High Speed

Airflow	Electricity Use	Airflow Efficiency
4987	49	102
Cubic Feet Per Minute	Watts (excluding lights)	Cubic Feet Per Minute Per Watt

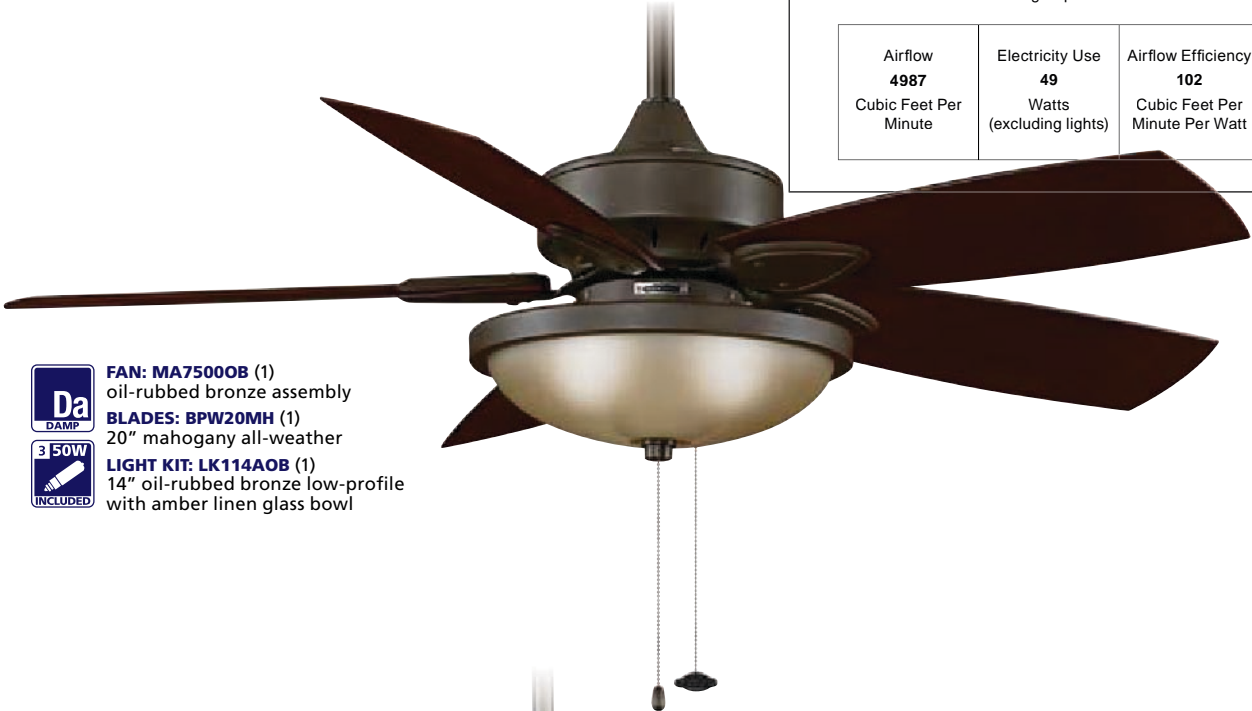

FAN: MA7500OB (1)
oil-rubbed bronze assembly

BLADES: BPW20MH (1)
20" mahogany all-weather



LIGHT KIT: LK114AOB (1)
14" oil-rubbed bronze low-profile
with amber linen glass bowl



FAN: MA7500AB (1)
antique brass assembly

BLADES: B6000TK (1)
36" teak curved wood

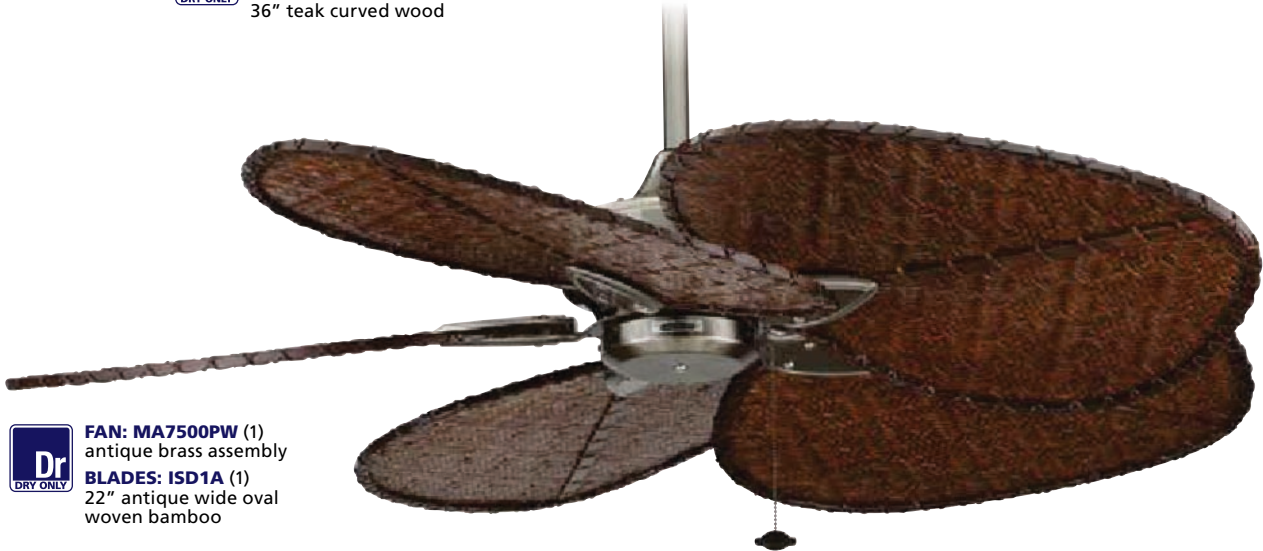

FAN: MA7500PW (1)
antique brass assembly

BLADES: ISD1A (1)
22" antique wide oval
woven bamboo



FAN: FP8009OB (1)
oil-rubbed bronze assembly
with all-weather composite
antique woven bamboo blades

LIGHT KIT: LKLP102OB (1)
oil-rubbed bronze low-profile
with white frosted glass



FAN: FP8009OB (1)
oil-rubbed bronze assembly with
all-weather composite antique
woven bamboo blades



FAN: FP8009OB (1)
oil-rubbed bronze assembly with
all-weather composite antique
woven bamboo blades



LIGHT KIT: LKLP101OB (1)
oil-rubbed bronze low-profile
with white frosted glass

THE CANCUN™

YOUR PERSONAL RESORT



52" CEILING FAN

ENERGY INFORMATION

at High Speed

Airflow	Electricity Use	Airflow Efficiency
5848	69	85
Cubic Feet Per Minute	Watts (excluding lights)	Cubic Feet Per Minute Per Watt

UNIPACKED
BLADES INCLUDED

LIMITED LIFETIME MOTOR WARRANTY

Finishes (swatches on page 132):

FP8009OB — OB fan | woven bamboo blade
FP8011OB — OB fan | woven bamboo blade | white frosted bowl

Blades:

22" blade set included (see finish above)

Motor:

172 x 20

Speeds:

3 forward and 3 reverse (reversing switch on switch cup)

Controls:

Optional controls available (pages 128-131)

Lighting:

FP8009OB—accepts standard fitters and light kits—sold separately (pages 124-127)
FP8011OB—two 75-watt halogen minican bulbs included

Downrod:

1" dia. x 6" long downrod included
Longer lengths available—p.132
Close-to-ceiling kit available—p.133

Ceiling slope

Up to 30° (52" with SCB1-52)

Location Use:

Dry and damp location rated

Net Hanging Weight:

FP8009OB—20.86 lbs.
FP8011OB—23.86 lbs.

UL LISTED

OPTIONS



THE CANCUN™

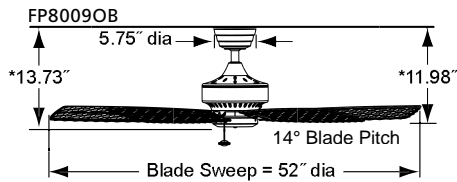

*With included 4.5" downrod

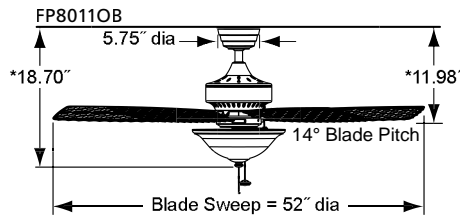

FAN: FP8011OB (1)

oil-rubbed bronze assembly with frosted white bowl light kit and all-weather composite antique woven bamboo blades

THE CANCUN™

YOUR PERSONAL RESORT

42" CEILING FAN

ENERGY INFORMATION

at High Speed

Airflow	Electricity Use	Airflow Efficiency
3943	47	84
Cubic Feet Per Minute	Watts (excluding lights)	Cubic Feet Per Minute Per Watt

UNIPACKED
BLADES INCLUDED

LIMITED LIFETIME MOTOR WARRANTY

Finishes (swatches on page 132):

FP8042OB — OB fan | CY/WA reversible blade
 FP8042SN — SN fan | CY/WA reversible blade
 FP8042WH — WH fan | WH blade

Blades:

17" blade set included (see finish above)

Motor:

153 x 13

Speeds:

3 forward and 3 reverse (reversing switch on switch cup)

Controls:

Optional controls available (p.128-131)

Lighting:

Accepts standard fitters and light kits—sold separately (p. 124-127)

Downrod:

Dual mount for flush mount application or 1" dia. x 4.5" long downrod (included)
 Longer length downrods available—p.132

Ceiling slope

Up to 30°

Location Use:

Dry location rated only

Net Hanging Weight:

15.37 lbs.

UL LISTED

OPTIONS

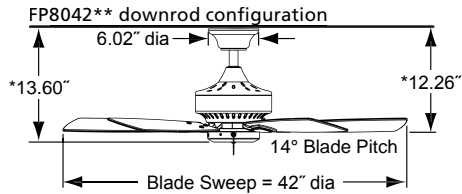

*With included 4.5" downrod

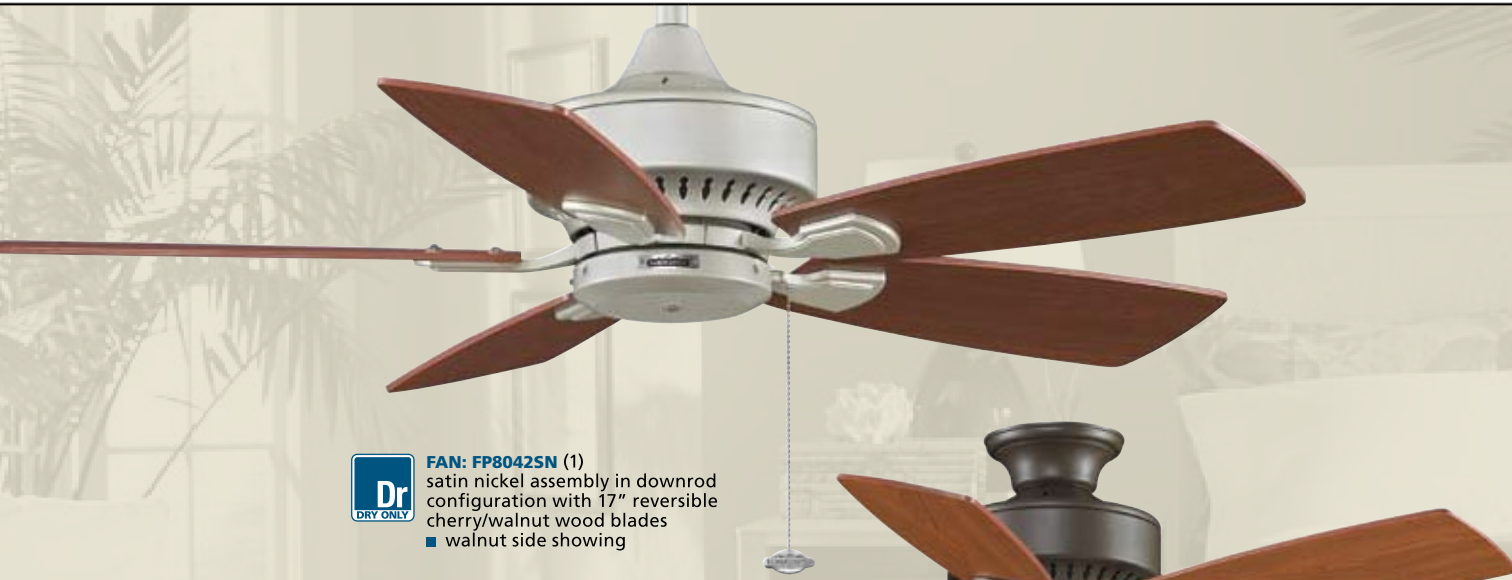
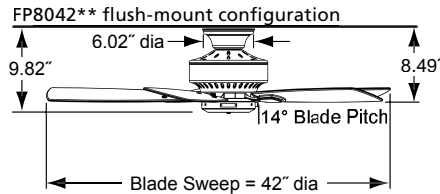

FAN: FP8042SN (1)
 satin nickel assembly in downrod configuration with 17" reversible cherry/walnut wood blades
 ■ walnut side showing

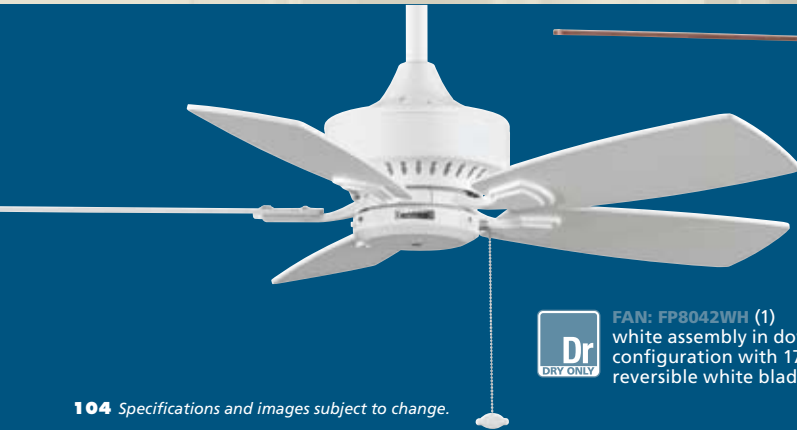

FAN: FP8042WH (1)
 white assembly in downrod configuration with 17" reversible white blades



FAN: FP8042OB (1)
 oil-rubbed bronze assembly in flush-mount configuration with 17" reversible cherry/walnut wood blades
 ■ walnut side showing

THE CANCUN™

YOUR PERSONAL RESORT

52" WET LOCATION FAN

ENERGY INFORMATION

at High Speed

Airflow	Electricity Use	Airflow Efficiency
5505	71	78
Cubic Feet Per Minute	Watts (excluding lights)	Cubic Feet Per Minute Per Watt

UNPACKED
BLADES INCLUDED

LIMITED LIFETIME MOTOR WARRANTY

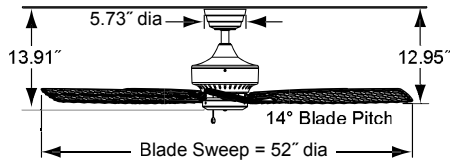

*With included 4.5" downrod

Finishes (swatches on page 132):

FP8012OB — OB fan | woven bamboo blade
FP8016OB — OB fan | woven bamboo blade | frosted white low-profile light kit

Downrod:

1" dia. x 4.5" long downrod included
Longer lengths available—p.132
Close-to-ceiling kit available—p.133

Blades:

22" blade set included (see finish above)

Motor:

188 x 25

Speeds:

3 forward and 3 reverse (reversing switch on switch cup)

Controls:

Optional controls available (p.128-131)

Lighting:

FP8012OB—accepts standard fitters and light kits—sold separately (pages 124-127)
FP8016OB—one 100-watt halogen minican bulb included

Ceiling slope

Up to 30° (52° with SCB1-52)

Location Use:

Dry, damp and wet location rated (housing and switch cup are made of all-weather composite materials instead of steel)

Net Hanging Weight:

FP8012OB—22.55
FP8016OB—23.61

UL LISTED

OPTIONS

#124-127
LIGHTING

#128-131
CONTROLS

We
WET

THE CANCUN™

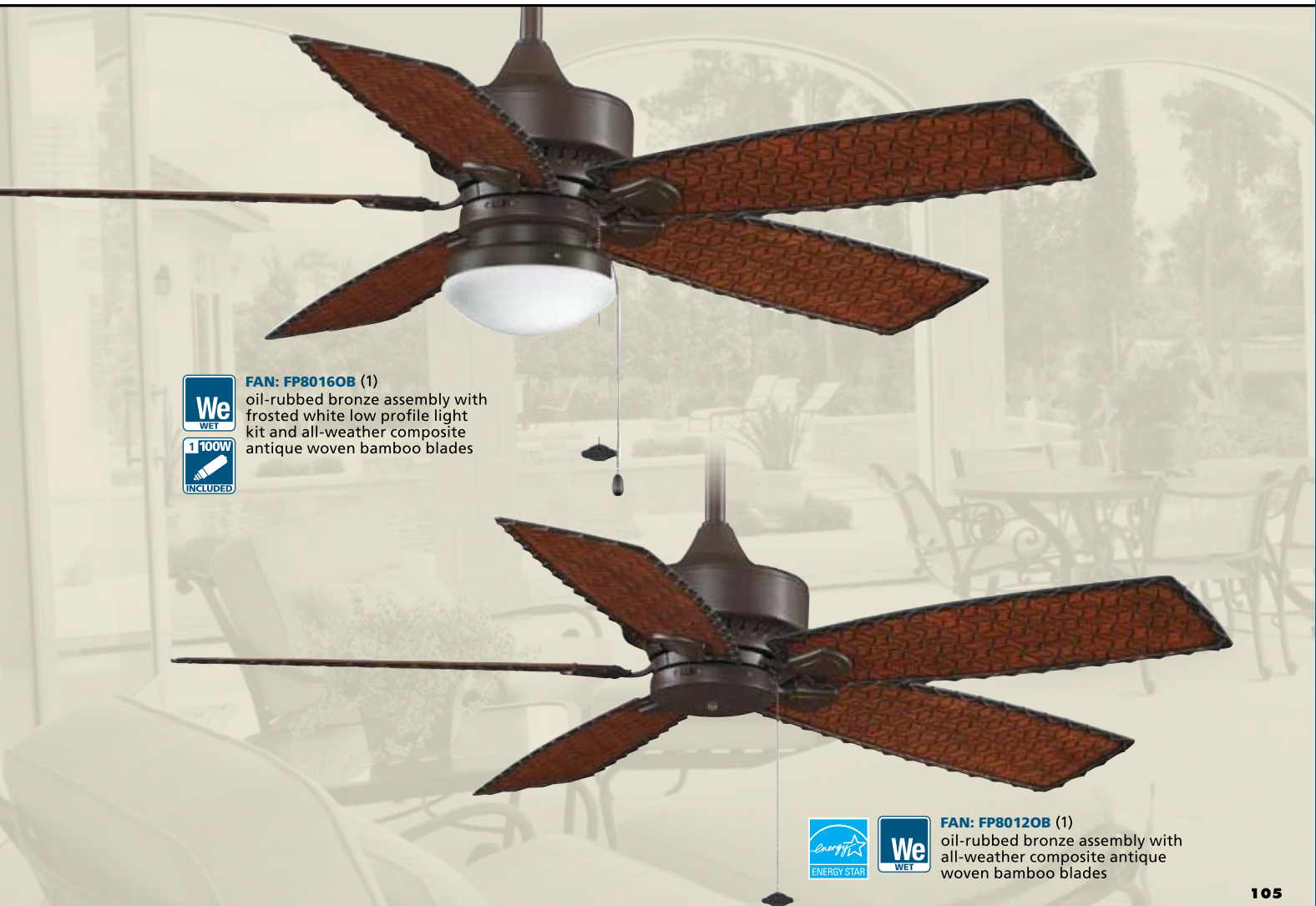

FAN: FP8016OB (1)
oil-rubbed bronze assembly with
frosted white low profile light
kit and all-weather composite
antique woven bamboo blades



FAN: FP8012OB (1)
oil-rubbed bronze assembly with
all-weather composite antique
woven bamboo blades



FAN: FP240AB (1)
antique brass assembly
EXTENSION POLE: EP30AB (1)
30" antique brass
BLADES: PAP1 (1)
22" natural palm leaf wide oval
FILIGREE: FLAB (1)
antique brass filigree accessory



FAN: FP240OB (1)
oil-rubbed bronze assembly
EXTENSION POLE: EP30OB (1)
30" oil-rubbed bronze
BLADES: B5080CP (1)
22" cairo purple wide oval wood

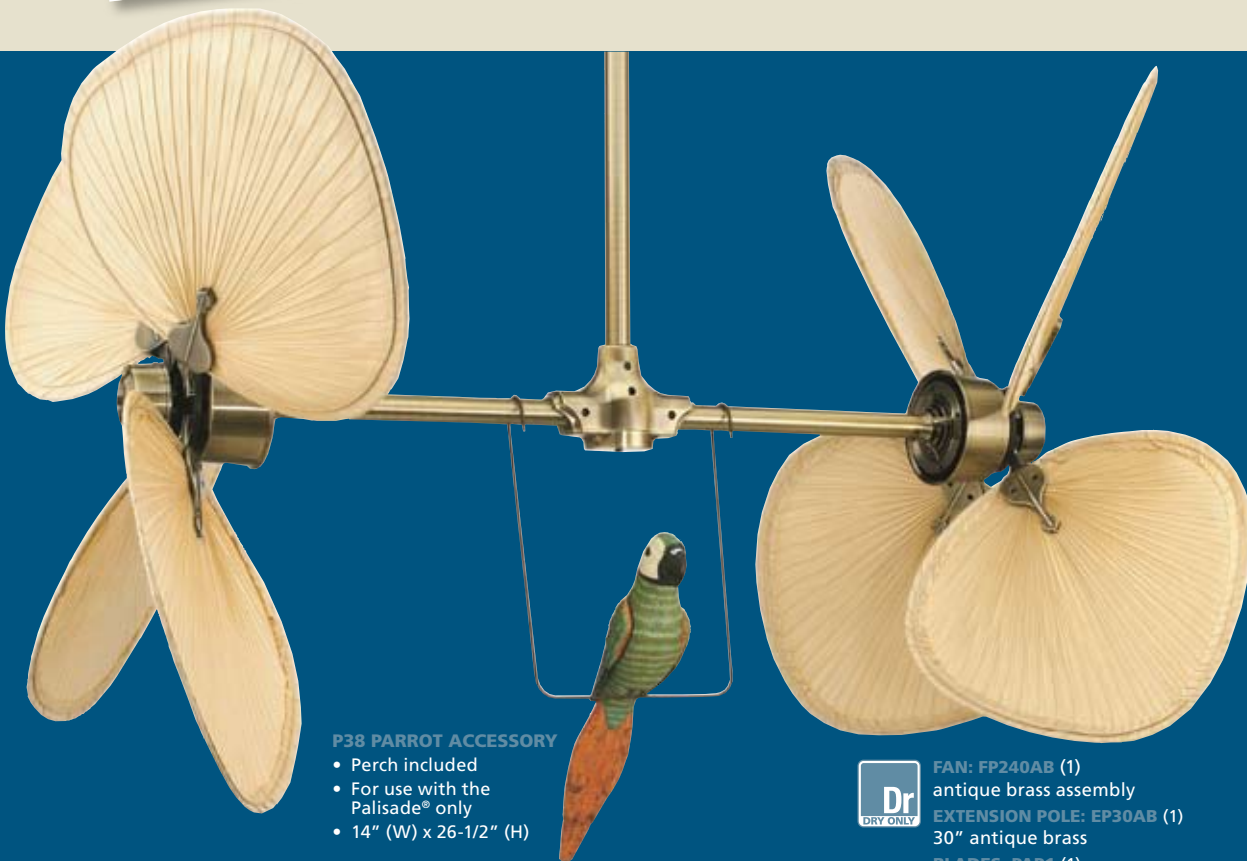

P38 PARROT ACCESSORY

- Perch included
- For use with the Palisade® only
- 14" (W) x 26-1/2" (H)



FAN: FP240AB (1)
antique brass assembly
EXTENSION POLE: EP30AB (1)
30" antique brass
BLADES: PAP1 (1)
22" natural palm leaf wide oval
ACCESSORY: P38 (1)
parrot

THE PALISADE®

A BREATH OF FRESH AIR

MULTICOMPONENT
MOTOR & BLADES

LIMITED LIFETIME MOTOR WARRANTY

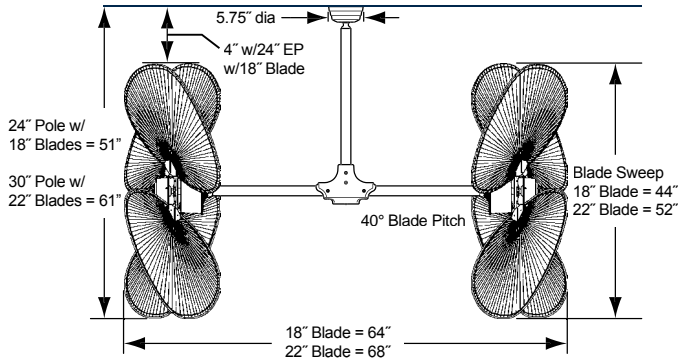

Finishes (swatches on page 132):

- AB Dry location only
- OB Dry and damp locations
- PW Dry location only
- RS Dry and damp locations

Blades:

Sold separately (pages 109, 134-137)

Motors:

FK2100 (2)

Speeds:

2 forward and 2 reverse

Controls:

Remote control adaptable with SW24 receiver and TR24**, sold separately (pages 128-131)

Lighting:

Wired for multiple lighting options (lights may be assembled at center or on the ends)

Extension Pole:

Required extension pole sold separately (page 132)
Minimum 24" extension pole and 11' 6" ceiling height is required with 18" blade sets
Minimum 30" extension pole and 12' ceiling height is required with 22" blade sets

Ceiling slope

Uses a ball and bracket hanger system; ceiling slope to 30° (up to 52° with SCB1-52)

Location Use:

See finishes

Net Hanging Weight:

52.8 lbs.

U.S. Pat # D 450, 380
U.S. TM Reg # D 2, 812, 018

UL LISTED

OPTIONS



THE PALISADE®



- FAN: FP2400B (1)**
oil-rubbed bronze assembly
- EXTENSION POLE: EP300B (1)**
30" oil-rubbed bronze
- BLADES: PAD1A (1)**
22" antique wide oval woven bamboo

EASY ORDERING STEPS:

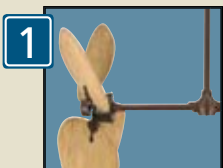

Select a motor and extension pole

Available finishes listed above
An extension pole is required, sold separately on page 132

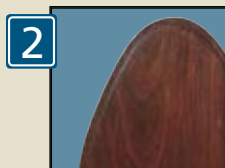

Select a blade set
(pages 109, 134-137)



Optional lighting
(page 124-127)

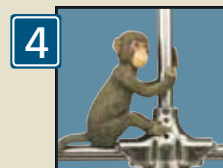

Optional accessories
(pages 106, 109 and 133)



Optional remote and wall controls
(pages 128-131)

THE PALISADE®



FAN: FP240OB (1)
oil-rubbed bronze assembly
EXTENSION POLE: EP30OB (1)
30" oil-rubbed bronze



BLADES: B5080SS (1)
22" sambel sand wide oval wood
FITTER: F423OB (1)
oil-rubbed bronze bowl fitter
GLASS: G450 (1)
amber bowl

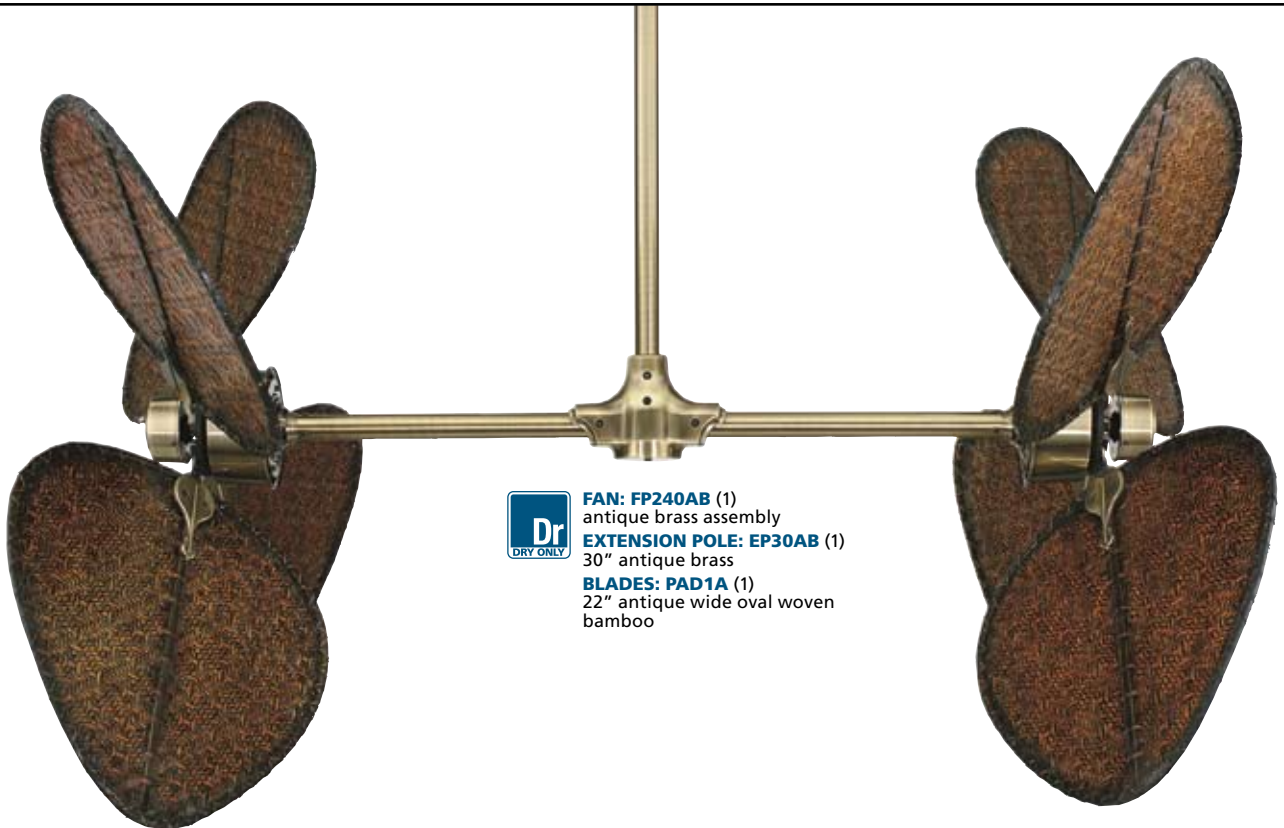

FAN: FP240AB (1)
antique brass assembly
EXTENSION POLE: EP30AB (1)
30" antique brass

BLADES: PAD1A (1)
22" antique wide oval woven
bamboo

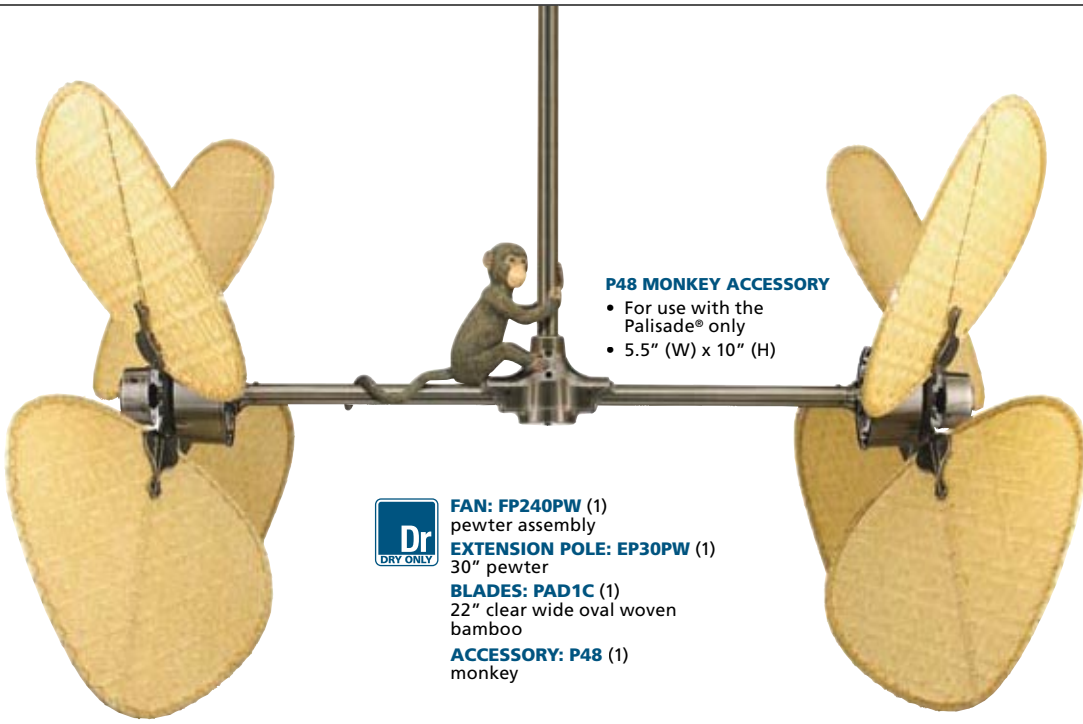

P48 MONKEY ACCESSORY

- For use with the Palisade® only
- 5.5" (W) x 10" (H)



- FAN: FP240PW** (1)
pewter assembly
- EXTENSION POLE: EP30PW** (1)
30" pewter
- BLADES: PAD1C** (1)
22" clear wide oval woven bamboo
- ACCESSORY: P48** (1)
monkey



- FAN: FP240RS** (1)
rust assembly
- EXTENSION POLE: EP30RS** (1)
30" rust
- BLADES: PAD1A** (1)
22" antique wide oval woven bamboo
- FILIGREE: FLRS** (1)
rust filigree accessory



BLADE SET OPTIONS

- These Palisade® blades are for use with the Palisade® only
- Blades sold separately in sets of eight
- 22" length
- Additional blade options on pages 128-130



B5080CP
Cairo purple



B5080SS
Sambel sand

FILIGREE ACCESSORY



- FLAB** antique brass
- FLOB** oil-rubbed bronze
- FLPW** pewter
- FLRS** rust



CW3WH WALL CONTROL INCLUDED:



- Wall control with face plate included
- Fan-only control
- 2 fan speeds



FAN: FP7000OB (1)
oil-rubbed bronze assembly
■ motor heads at 30°
BLADES: CAISD4A (1)
22" antique narrow oval
woven bamboo



FAN: FP7000OB (1)
oil-rubbed bronze assembly
■ motor heads at 30°
BLADES: CABPW10CY (1)
20.5" cherry all-weather
composite



FAN: FP7000PW (1)
pewter assembly
■ motor heads at 30°
BLADES: CAISD7A (1)
22" antique oar
shaped woven bamboo

THE CARUSO™

GET LOST IN THE COOL BREEZES OF THE TROPICS

MULTICOMPONENT
MOTOR & BLADES

LIMITED LIFETIME MOTOR WARRANTY

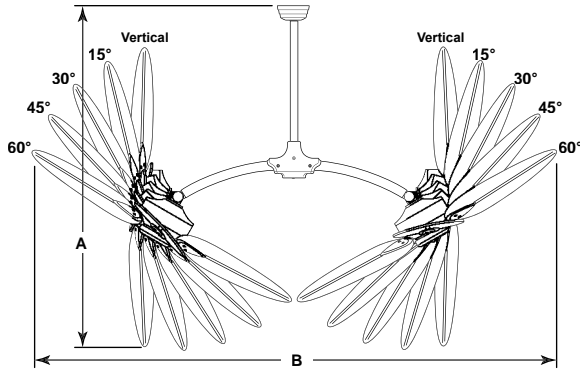

Motor Tilt Angle	18" Blades		20" Blades		22" Blades	
	Dim. A w/24" DR	Dim. B w/24" DR	Dim. A w/24" DR	Dim. B w/24" DR	Dim. A w/24" DR	Dim. B w/24" DR
Vertical	54.5"	56.5"	56.5"	56.5"	58.5"	56.5"
15°	55.0"	63.5"	58.0"	64.5"	59.0"	65.5"
30°	54.5"	73.0"	56.0"	75.0"	58.0"	77.0"
45°	52.5"	80.5"	54.0"	83.0"	55.0"	86.0"
60°	49.0"	85.0"	50.0"	88.5"	*51.0"	*92.0"

*CAISP4—22" natural palm blades—are NOT to be used at the 60° setting

Finishes (swatches on page 132):

- AB Dry location only
- OB Dry and damp locations
- PW Dry location only

Blades:

Sold separately (pages 134-137)

Motors:

188 x 25 (2)
Adjustable motor heads provide five angles of tilt ranging from vertical to 60° from vertical in 15° increments

Speeds:

2 forward and 2 reverse (switch on switch cups)

Controls:

Remote control adaptable with SW70 receiver and TR24**, sold separately (pages 128-131)

Lighting:

Wired for multiple lighting options (lights may be assembled at center or on the ends)

Downrod:

1" dia. x 24" long downrod included
Longer lengths available—p.132
A shorter downrod may be used with various motor angles and blade length combinations (see specification sheet)

Ceiling slope

Ceiling slope to 30° (up to 52° with SCB1-52)

Ceiling height

Minimum of 12' with the provided 24" downrod and 22" blade set (with vertical blade rotation)
Minimum of 11' using an 18" downrod and 18" blade set (with vertical blade rotation)

Location Use:

See finishes

Net Hanging Weight:

60 lbs. (fan only)

U.S. Pat # D 433, 118
U.S. Pat # D 450, 380
U.S. Pat # D 434, 134

UL LISTED

OPTIONS



THE CARUSO™

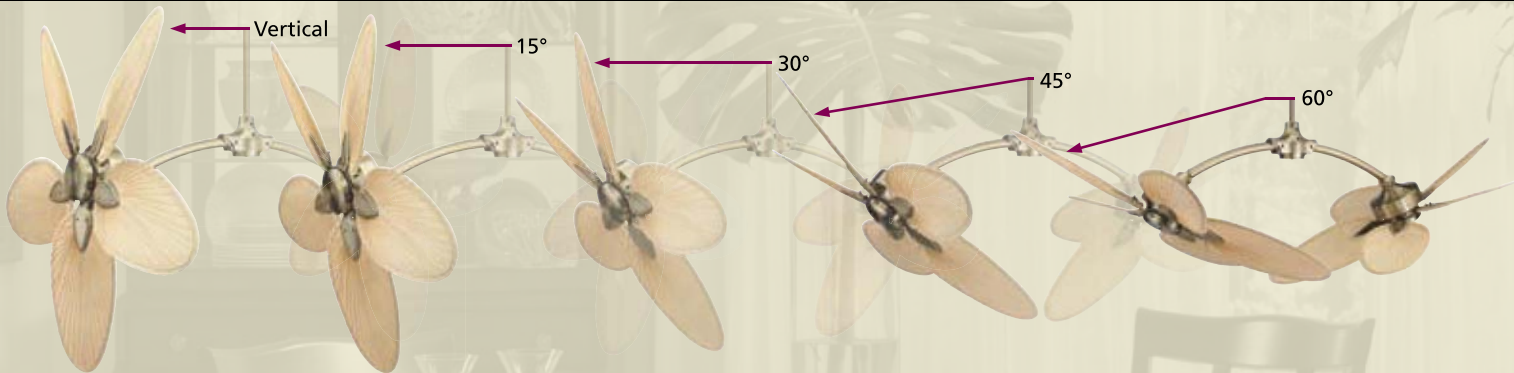

FAN: FP7000AB (1)
antique brass assembly
BLADES: CAISP4 (1)
22" natural finish
narrow oval palm



WALL CONTROL INCLUDED:



CW3WH-CA

- Fan-only control with face plate included
- 2 fan speeds

EASY ORDERING STEPS:

1

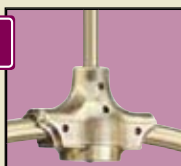

Select fan assembly
Available finishes listed above

2

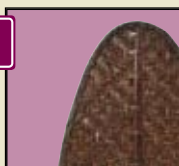

Select a blade set
(pages 134-137)

3

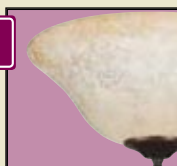

Optional lighting & accessories
(pages 124-127, 132-133)

4



Optional remote and wall controls
(pages 128-131)

THE CARUSO™



FAN: FP7000OB (1)
oil-rubbed bronze assembly
■ motor heads at 30°
BLADES: CAISD2A (1)
18" antique wide oval woven
bamboo



FAN: FP7000OB (1)
oil-rubbed bronze assembly
■ motor heads at 30°
BLADES: CABPP4BR (1)
22" brown/red all-weather
composite narrow oval palm



FAN: FP7000AB (1)
antique brass assembly
■ motor heads at 30°
BLADES: CAISP4 (1)
22" natural finish
narrow oval palm



FAN: FP70000B (1)
oil-rubbed bronze assembly
■ motor heads at 30°
BLADES: CAISD4A (1)
22" antique narrow oval
woven bamboo



FAN ASSEMBLY: FP602AB (1)
antique brass
■ two sections shown
BLADE SET: PMD2AAB (2)
18" antique brass assemblies
with antique woven bamboo
wide oval blade sets

THE PALMETTO®

THE CHARM OF YESTERYEAR

MULTICOMPONENT
MOTOR & BLADES

For dimensions and configurations, please see our comprehensive Specification Book or model-specific specification sheet, available at www.fanimation.com

Finishes (swatches on page 132):

AB
BL

Blades:

Sold separately, includes 3-blade assembly and hub (pages 134-137)

Speeds:

Single speed (approximately 15 RPM)

Features:

Versatile overall length, 10' up to 50', combine one to five sections; list catalog number FP601 for one section, FP602 for two sections, FP603 for three sections, FP604 for four sections and FP605 for five sections

Vertical blade rotation

1 to 3 blade sets per 9' shaft

Ceiling Height:

Minimum ceiling height of 12' or higher required

Location Use:

Dry location rated only

Not for use in sound-sensitive areas

5-year motor warranty

OPTIONS



THE PALMETTO®

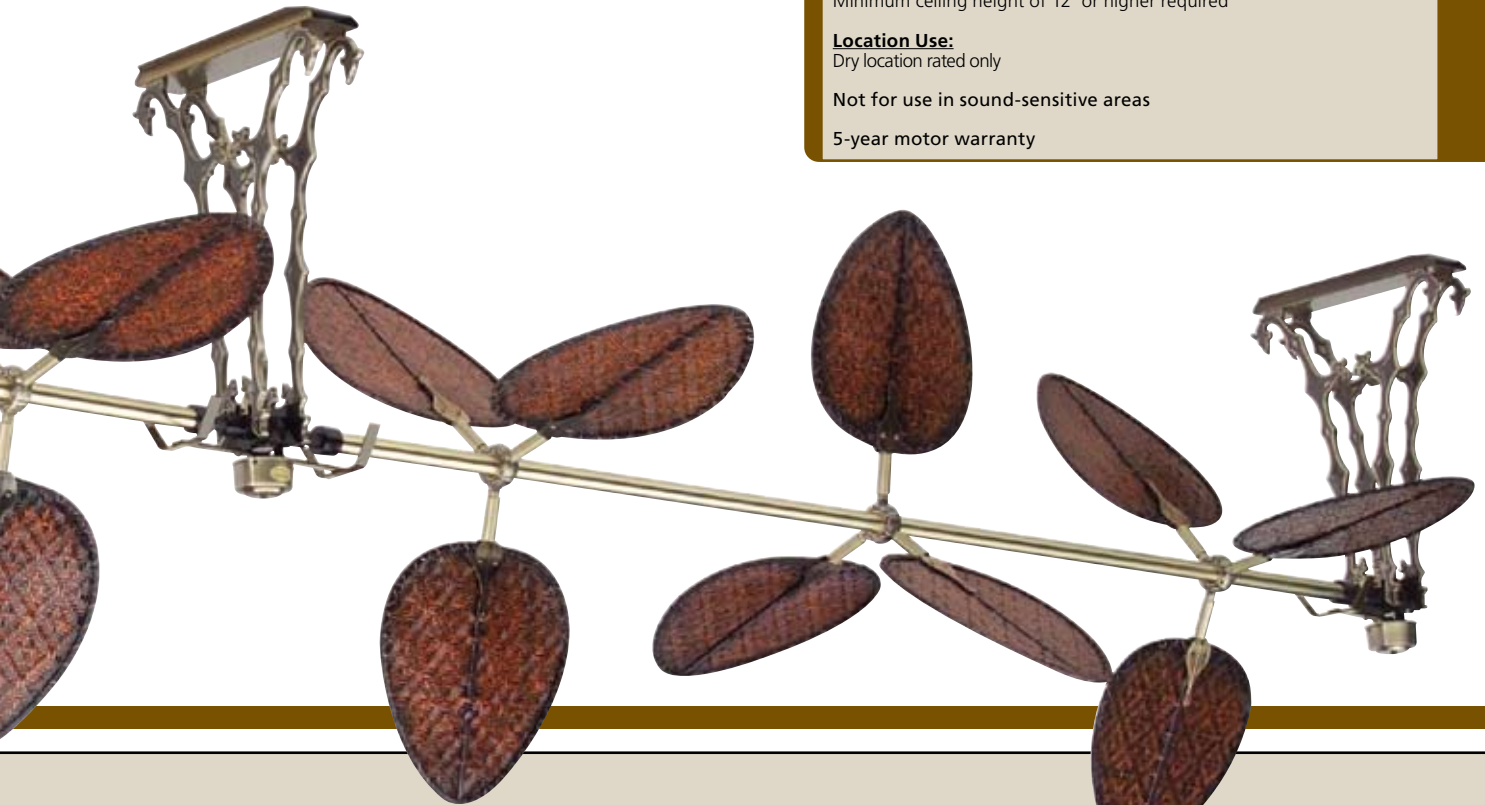

EASY ORDERING STEPS:



1 Select finish and number of sections (up to five)

Select from antique brass or black
Single speed, chain-driven motor built into on section;
only one motor needed for up to five sections
Versatile overall length, 10' up to 50', combine one to
five sections; list catalog number FP601 for one section,
FP602 for two sections, FP603 for three sections, FP604
for four sections and FP605 for five sections



2 Select a blade set
(pages 134-137)

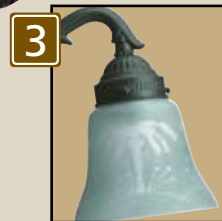

3 Optional lighting
(pages 124-127)



MOTOR: FP780AB (1)
antique brass
FAN ASSEMBLIES: FP720AB (4)
antique brass
■ shown in a ceiling mount application
BLADES: PUD1A (4)
22" antique woven bamboo wide oval

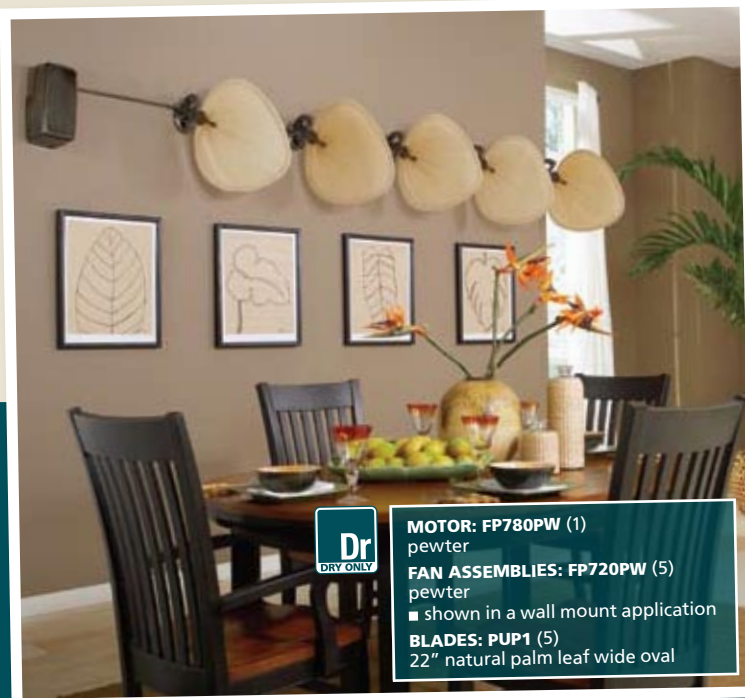

MOTOR: FP780PW (1)
pewter
FAN ASSEMBLIES: FP720PW (5)
pewter
■ shown in a wall mount application
BLADES: PUP1 (5)
22" natural palm leaf wide oval

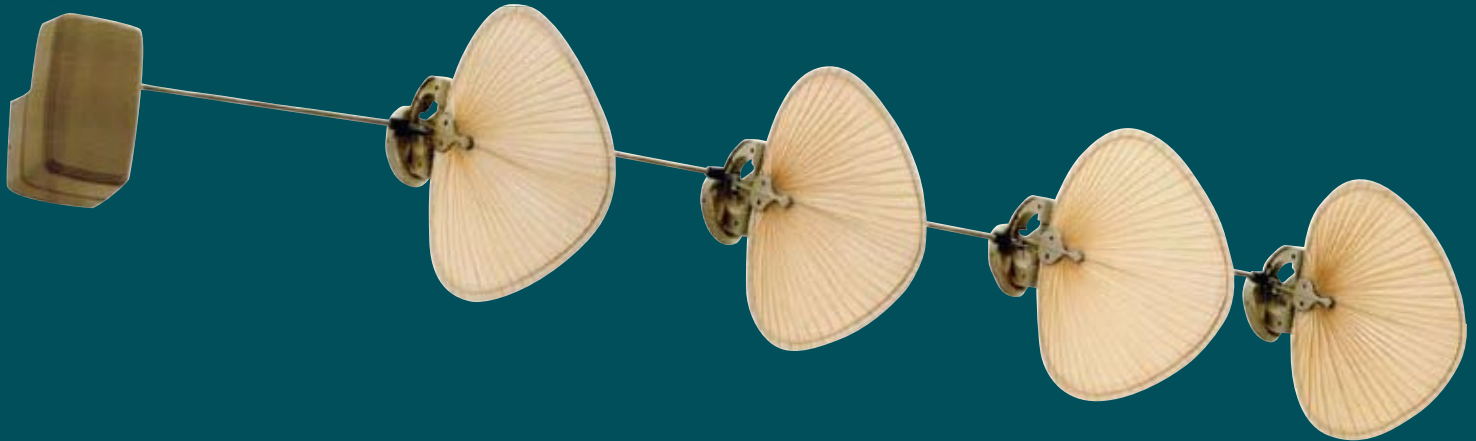

MOTOR: FP780AB (1)
antique brass
FAN ASSEMBLIES: FP720AB (4)
antique brass
■ shown in a wall mount application
BLADES: PUP1 (4)
22" natural palm leaf wide oval

THE PUNKAH®

OLD-WORLD GRACE AND SOPHISTICATION

MULTICOMPONENT
MOTOR & BLADES

LIMITED LIFETIME MOTOR WARRANTY

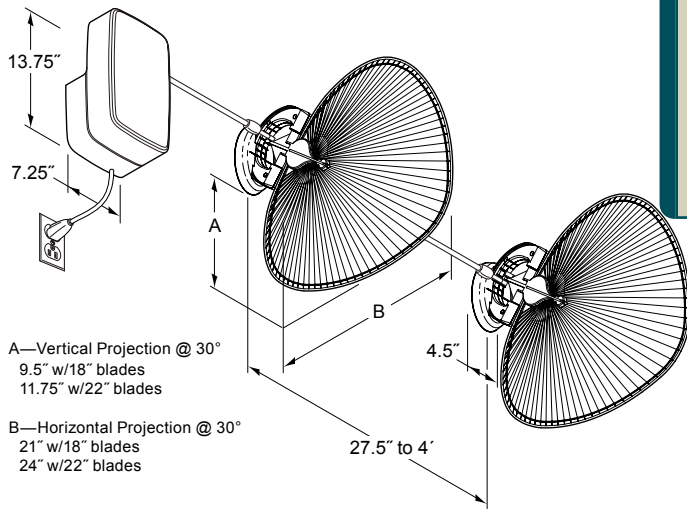

Finishes (swatches on page 132):

AB fan (dry location rated only)
PW fan (dry location rated only)
RS fan (damp location rated when used with PUD1A blade set)

Blades:

Sold separately (pages 134-137)

Motor:

FK2100

Speeds:

Single-speed

Features:

Designed for ceiling or wall mount
System length can be expanded up to 24' (connecting up to 6 fan assemblies to one motor)
Not for use in sound-sensitive areas

Net Hanging Weight:

Motor assembly: 17.5 lbs.
Fan assembly: 5 lbs. ea.

UL LISTED

OPTIONS

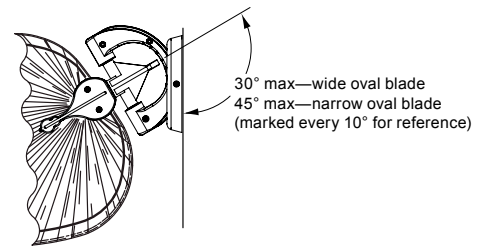

THE PUNKAH®



MOTOR: FP780PW (1)
pewter

FAN ASSEMBLIES: FP720PW (6)
pewter

■ shown in a ceiling mount application
BLADES: PUD1A (6)
22" antique woven bamboo wide oval

EASY ORDERING STEPS:



Select a motor

Available finishes listed above

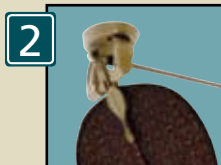

Select a fan assembly

Each sold separately

One to six fan assemblies can be run on a single motor

Note the number of fan assemblies desired when ordering



Select a blade set

(pages 134-137)

THE EDGEWOOD[®]



DELUXE WET LOCATION FAN

ENERGY INFORMATION

at High Speed

Airflow	Electricity Use	Airflow Efficiency
9173	97	94
Cubic Feet Per Minute	Watts (excluding lights)	Cubic Feet Per Minute Per Watt

UNPACKED
BLADES INCLUDED

LIMITED LIFETIME MOTOR WARRANTY

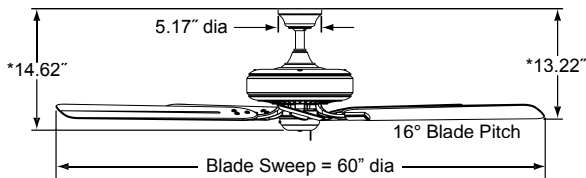

*With included 4.5" downrod

Finishes (swatches on page 132):

TF971AZ — AZ fan | dark cherry blade
 TF971SN — SN fan | mahogany blade
 TF971WH — WH fan | white blade

Downrod:

1" dia. x 4.5" long downrod (included)
 Longer length downrods available—p.132

Blades:

26" blade set included (see finish above)

Ceiling slope

Up to 30° (52° with SCB1-52)

Motor:

212 x 25

Location Use:

Dry, damp and wet location rated

Speeds:

3 forward and 3 reverse (reversing switch on switch cup)

Net Hanging Weight:

32.1 lbs.

Controls:

Optional controls available (p.128-131)

UL LISTED

Lighting:

Accepts standard fitters and light kits—sold separately (p. 124-127)

OPTIONS



FAN: TF971AZ (1)
aged bronze assembly with all-weather composite dark cherry blades

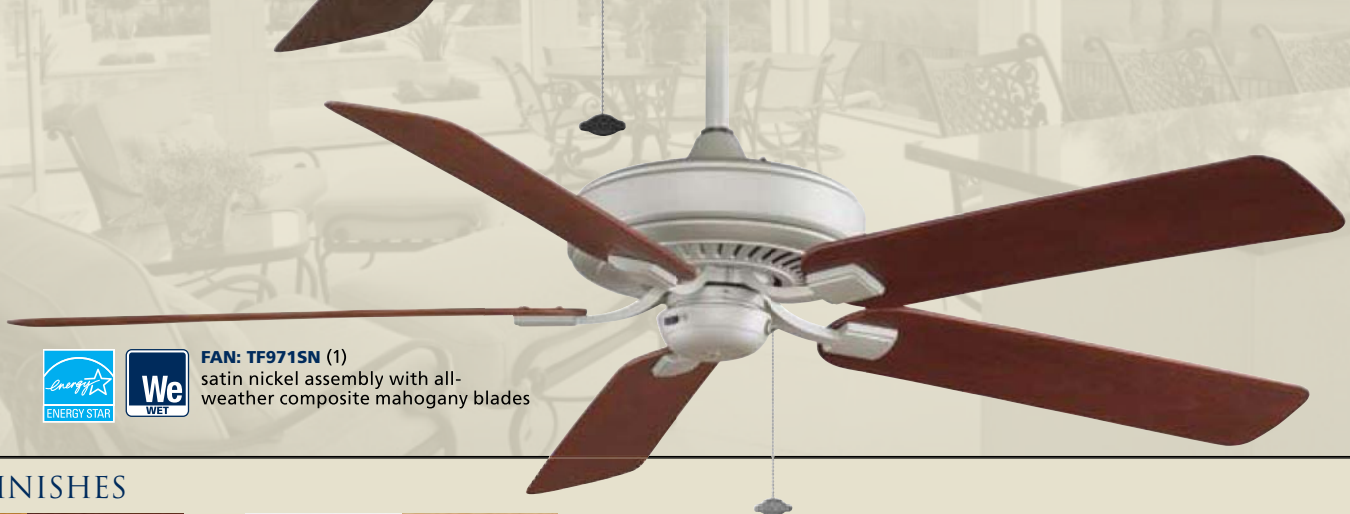

FAN: TF971SN (1)
satin nickel assembly with all-weather composite mahogany blades

BLADE FINISHES



reversible walnut/light walnut
TF721SN | TF721TS



white/white oak
TF721WH

THE EDGEWOOD®



WET LOCATION FAN

ENERGY INFORMATION

at High Speed

Airflow	Electricity Use	Airflow Efficiency
5570 Cubic Feet Per Minute	61 Watts (excluding lights)	92 Cubic Feet Per Minute Per Watt

UNPACKED
BLADES INCLUDED

LIMITED LIFETIME MOTOR WARRANTY

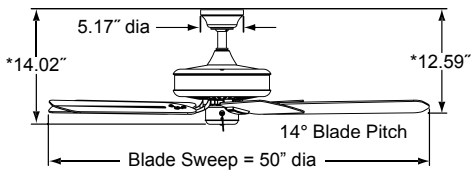

*With included 4.5" downrod

Finishes (swatches on page 132):

TF910AZ — AZ fan | dark cherry blade
 TF910SN — SN fan | mahogany blade
 TF910WH — WH fan | white blade

Downrod:

1" dia. x 4.5" long downrod (included)
 Longer length downrods available—p.132

Blades:

21" blade set included (see finish above)

Ceiling slope

Up to 30°

Motor:

188 x 15

Location Use:

Dry, damp and wet location rated

Speeds:

3 forward and 3 reverse (reversing switch on switch cup)

Net Hanging Weight:

19.73 lbs.

Controls:

Optional controls available (p.128-131)

UL LISTED

Lighting:

Accepts standard fitters and light kits—sold separately (p. 124-127)

OPTIONS



THE EDGEWOOD® SERIES

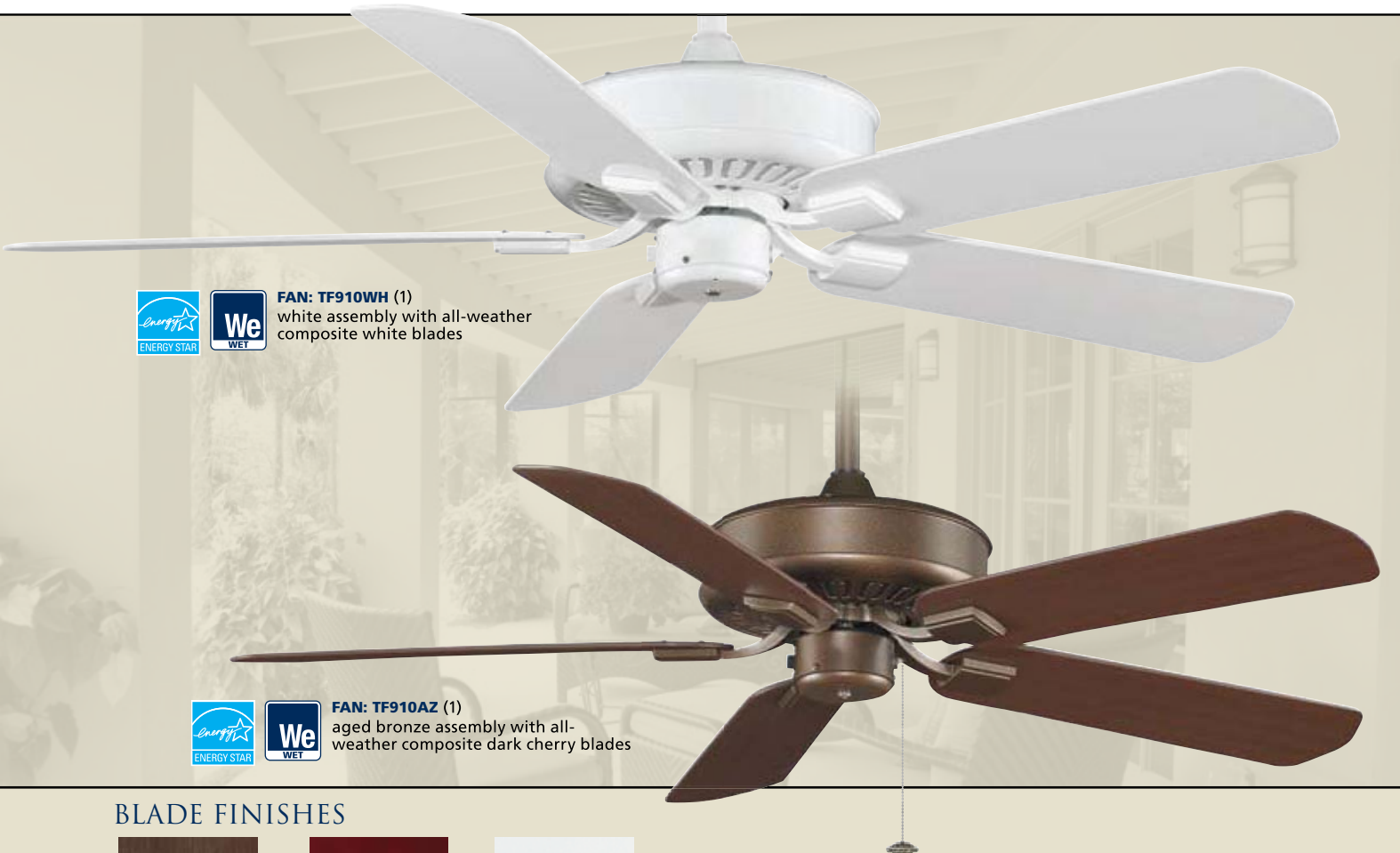

FAN: TF910WH (1)
 white assembly with all-weather composite white blades



FAN: TF910AZ (1)
 aged bronze assembly with all-weather composite dark cherry blades

BLADE FINISHES



dark cherry
TF910AZ



mahogany
TF910SN

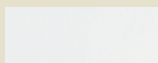

white
TF910WH

THE EDGEWOOD[®]



SUPREME FAN

ENERGY INFORMATION at High Speed

Airflow	Electricity Use	Airflow Efficiency
9689 Cubic Feet Per Minute	90 Watts (excluding lights)	107 Cubic Feet Per Minute Per Watt

UNIPACKED
BLADES INCLUDED

LIMITED LIFETIME MOTOR WARRANTY

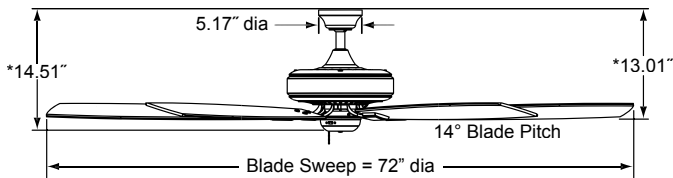

*With included 4.5" downrod

Finishes (swatches on page 132):

- TF721SN — SN fan | reversible walnut/light walnut blade
- TF721TS — TS fan | reversible walnut/light walnut blade
- TF721WH — WH fan | reversible white/white oak blade

Blades:

32" blade set included (see finish above)

Motor:

212 x 35

Speeds:

3 forward and 3 reverse (reversing switch on switch cup)

Controls:

Optional controls available (p.128-131)

Lighting:

Accepts standard fitters and light kits—sold separately (p. 124-127)

Downrod:

1" dia. x 4.5" long downrod (included)

Longer length downrods available—p.132

Close-to-ceiling kit available—p.133

Ceiling slope:

Up to 30°

Location Use:

Dry location rated only

Net Hanging Weight:

37.92 lbs.

ETL LISTED

OPTIONS

p.124-127

LIGHTING

p.128-131

CONTROLS

Dr
DRY ONLY



FAN: TF721TS (1)
tortoise shell assembly with reversible walnut/light walnut wood blades
■ walnut side showing



FAN: TF721SN (1)
satin nickel assembly with reversible walnut/light walnut wood blades
■ walnut side showing

BLADE FINISHES



reversible walnut/light walnut
TF721SN | TF721TS



white/white oak
TF721WH

THE EDGEWOOD®



DELUXE AND DECORATIVE FANS

ENERGY INFORMATION

at High Speed

Airflow	Electricity Use	Airflow Efficiency
TF610: 6876	87	80
TF710: 7893	82	96
Cubic Feet Per Minute	Watts (excluding lights)	Cubic Feet Per Minute Per Watt

UNIPACKED
BLADES INCLUDED

LIMITED LIFETIME MOTOR WARRANTY

Finishes (swatches on page 132):

TF610/710SN — SN fan | reversible walnut/light walnut blade
 TF610/710TS — TS fan | reversible walnut/light walnut blade
 TF610/710WH — WH fan | reversible white/white oak blade

Blades:

TF610—22" blade set included (see finish above)
 TF710—26" blade set included (see finish above)

Motor:

TF610—188 x 20
 TF710—212 x 25

Speeds:

3 forward and 3 reverse (reversing switch on switch cup)

Controls:

Optional controls available (p.128-131)

Lighting:

Accepts standard fitters and light kits—sold separately (p. 124-127)

Downrod:

1" dia. x 4.5" long downrod (included)
 Longer length downrods available—p.132

Ceiling slope:

Up to 30°

Location Use:

Dry location rated only

Net Hanging Weight:

TF610—21.19 lbs
 TF710—29.78 lbs

UL LISTED

OPTIONS

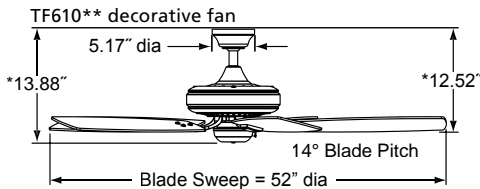

*With included 4.5" downrod

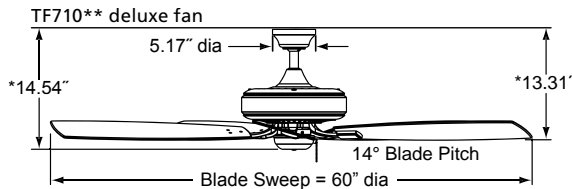

DELUXE FAN: TF710TS (1)
 tortoise shell assembly with reversible walnut/light walnut wood blades
 ■ walnut side showing



LIGHT KIT: LK114ATS (1)
 14" tortoise shell low-profile with amber linen glass bowl



DECORATIVE FAN: TF610SN (1)
 satin nickel assembly with reversible walnut/light walnut wood blades
 ■ walnut side showing

BLADE FINISHES



reversible walnut/light walnut
TF610/710SN | TF610/710TS



white/white oak
TF610/710WH



FAN: BP200SN1 (1)
satin nickel assembly in flush-mount configuration with reversible cherry/walnut wood blades
■ walnut side showing



FAN: BP200OB1 (1)
oil-rubbed bronze assembly with reversible cherry/walnut wood blades
■ walnut side showing



FAN: BP200MW1 (1)
matte white assembly in downrod configuration with matte white wood blades



FAN: BP210SN1 (1)
satin nickel assembly in downrod configuration with white frosted glass shades and reversible cherry/walnut wood blades
■ walnut side showing



FAN: BP210OB1 (1)
oil-rubbed bronze assembly in downrod configuration with amber glass shades and reversible cherry/walnut wood blades
■ walnut side showing



FAN: BP210MW1 (1)
matte white assembly in downrod configuration with white frosted glass shades and matte white wood blades



FAN: BP215OB1 (1)
oil-rubbed bronze assembly in downrod configuration with white frosted glass shades and reversible cherry/walnut wood blades
■ cherry side showing



FAN: BP230OB1 (1)
oil-rubbed bronze assembly in downrod configuration with all-weather composite walnut blades



FAN: BP230SN1 (1)
satin nickel assembly in flush-mount configuration with all-weather composite cherry blades



FAN: BP230MW1 (1)
matte white assembly in downrod configuration with all-weather composite matte white blades



By Fanimation®



ENERGY INFORMATION at High Speed

Airflow	Electricity Use	Airflow Efficiency
BP200/BP210/ BP215/BP220/ BP225:	64	92
BP230:	64	91
Cubic Feet Per Minute	Watts (excluding lights)	Cubic Feet Per Minute Per Watt

UNPACKED
BLADES INCLUDED

LIMITED LIFETIME MOTOR WARRANTY

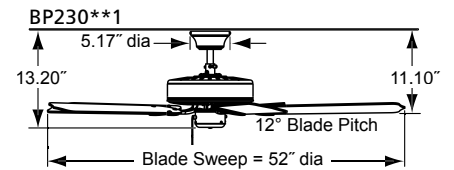
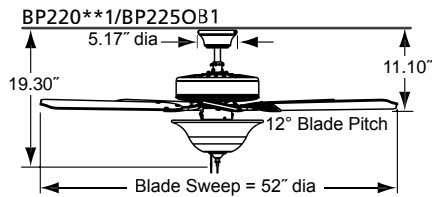
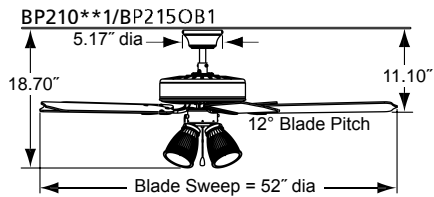
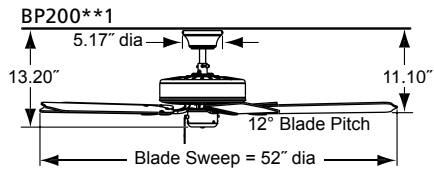

Finishes (swatches on page 132):

- BP200OB1 —OB fan | reversible CY/WA blade
- BP200SN1 —SN fan | reversible CY/WA blade
- BP200MW1 —MW fan | WH blade
- BP210OB1 —OB fan | reversible CY/WA blade | four amber glass shades
- BP210SN1 —SN fan | reversible CY/WA blade | four white frosted shades
- BP210MW1 —MW fan | MW blade | four white frosted shades
- BP215OB1 —OB fan | reversible CY/WA blade | four white frosted shades
- BP220OB1 —OB fan | reversible CY/WA blade | amber glass bowl
- BP220SN1 —SN fan | reversible CY/WA blade | white frosted glass bowl
- BP220MW1 —MW fan | MW blade | white frosted bowl
- BP225OB1 —OB fan | reversible CY/WA blade | white frosted bowl
- BP230OB1 —OB fan | WA composite blade
- BP230SN1 —SN fan | CY composite blade
- BP230MW1 —MW fan | MW composite blade

Speeds:

3 forward and 3 reverse (reversing switch on switch cup)

Controls:

Optional controls available (p.128-131)

Lighting:

BP210/BP215—four 40-watt candelabra BP220/BP225—three 60-watt candelabra BP200 & BP230 Accept standard fitters and light kits—sold separately (p. 124-127)

Downrod:

Dual mount for flush mount application or 1" dia. x 4.5" long downrod (included) Longer length downrods available—p.132

Ceiling slope

Up to 30°

Location Use:

All dry location rated except BP230**—dry and damp location rated

Net Hanging Weight:

BP200**1 = 16.31 lbs
BP210**1/BP215OB1 = 20.94 lbs
BP220**1/BP225OB1 = 18.50 lbs
BP230**1 = 16.31 lbs

Blades:

20.7" blade set included (see finish above)

Motor:

153 x 15

UL LISTED

OPTIONS

124-127



128-131



AIRE DÉCOR®



FAN: BP220SN1 (1)
satin nickel assembly in downrod configuration with white frosted glass bowl and reversible cherry/walnut wood blades
■ walnut side showing



FAN: BP220OB1 (1)
oil-rubbed bronze assembly in flush-mount configuration with amber glass bowl and reversible cherry/walnut wood blades
■ walnut side showing

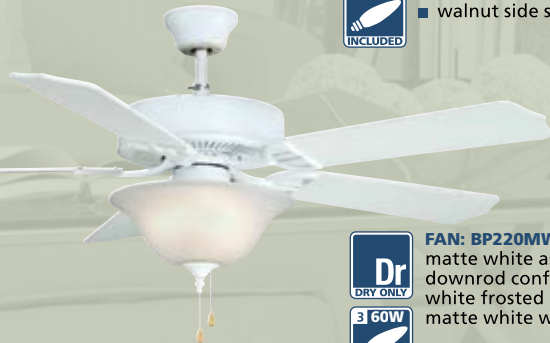

FAN: BP220MW1 (1)
matte white assembly in downrod configuration with white frosted glass bowl and matte white wood blades



FAN: BP225OB1 (1)
oil-rubbed bronze assembly in downrod configuration with white frosted glass bowl and reversible cherry/walnut wood blades
■ walnut side showing

BLADE FINISHES



reversible cherry/walnut

BP200OB1 | BP200SN1 | BP210OB1 | BP210SN1
BP215OB1 | BP220OB1 | BP220SN1 | BP225OB1

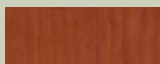

cherry

BP230SN1

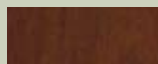

walnut

BP230OB1

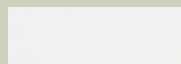

matte white

BP200MW1 | BP210MW1
BP220MW1 | BP230MW1

LIGHT KITS

- Light kits are for use with most Fanimation fans
- Light bulb requirements vary and are listed for each light kit
- Pull-chain light kits come with chain and fob
- Light kits rated for both dry and damp locations are noted with DAMP next to the finish
- Light bulbs included
- **UL LISTED**



LK112A antique bamboo with white frosted glass, **DAMP**

- 6" (H) x 10" (W)



LK122A antique bamboo with white frosted glass, **DAMP**

- 8" (H) x 13" (W)



LK500AB antique brass bronze accent
LK500BA black (shown), **DAMP**
LK500BL matte white, **DAMP**
LK500MW oil-rubbed bronze, **DAMP**
LK500OB pewter
LK500PW rust, **DAMP**
LK500RS satin nickel, **DAMP**
LK500SN

- 10.6" (H) x 15.5" (W)

Same light output as three 75-watt halogen bulbs or six 60-watt candelabra bulbs!



LKFL250 white frosted 13" bowl light kit, **DAMP**

- 8" (H) x 13" (W)
- 4,800 lumens light output



LKFL260 amber frosted 13" bowl light kit, **DAMP**

- 8" (H) x 13" (W)
- 4,800 lumens light output



LK250 white frosted 13" bowl light kit, **DAMP**

- 8" (H) x 13" (W)



LK260 amber frosted 13" bowl light kit, **DAMP**

- 8" (H) x 13" (W)



LK5620 opal frosted 13" modern bowl light kit, **DAMP**

- 8" (H) x 13" (W)



LK113WH white fabric 14" drum lamp shade
 • 6.9" (H) x 14" (W)



LK114AAB antique brass
LK114AAZ aged bronze, **DAMP**
LK114ABA bronze accent
LK114AOB oil-rubbed bronze, **DAMP**
LK114ARS rust, **DAMP**
LK114ATS tortoise shell, **DAMP**
 • low-profile bowl light kit
 • amber linen glass
 • pull chain operation
 • 4.8" (H) x 14" (W)



LK114MMW matte white, **DAMP**
LK114WPW pewter
LK114WSN satin nickel, **DAMP**
LK114WWH white, **DAMP**
 • low-profile bowl light kit
 • white linen glass
 • pull chain operation
 • 4.8" (H) x 14" (W)



LKLP101AB antique brass
LKLP101AZ aged bronze, **DAMP**
LKLP101BA bronze accent
LKLP101MW matte white, **DAMP**
LKLP101OB oil-rubbed bronze, **DAMP**
LKLP101PW pewter
LKLP101RS rust, **DAMP**
LKLP101SN satin nickel, **DAMP**
LKLP101TS tortoise shell, **DAMP**
LKLP101WH white, **DAMP**
 • low-profile light kit
 • opal frosted glass
 • pull chain operation
 • 8.5" (H) x 5.2" (W)



LKLP102AB antique brass
LKLP102AZ aged bronze, **DAMP**
LKLP102BA bronze accent
LKLP102MW matte white, **DAMP**
LKLP102OB oil-rubbed bronze, **DAMP**
LKLP102PW pewter
LKLP102RS rust, **DAMP**
LKLP102SN satin nickel, **DAMP**
LKLP102TS tortoise shell, **DAMP**
LKLP102WH white, **DAMP**
 • low-profile light kit
 • opal frosted glass
 • pull chain operation
 • 8.5" (H) x 5.2" (W)



LKLP111AAB antique brass
LKLP111AAZ aged bronze, **DAMP**
LKLP111ABA bronze accent
LKLP111AOB oil-rubbed bronze, **DAMP**
LKLP111ARS rust, **DAMP**
LKLP111ATS tortoise shell, **DAMP**
 • low-profile light kit
 • amber linen glass
 • pull chain operation
 • 8.5" (H) x 5.2" (W)



LKLP111MMW matte white, **DAMP**
LKLP111WPW pewter
LKLP111WSN satin nickel, **DAMP**
LKLP111WWH white, **DAMP**
 • low-profile light kit
 • white linen glass
 • pull chain operation
 • 8.5" (H) x 5.2" (W)



LKLP112AAB antique brass
LKLP112AAZ aged bronze, **DAMP**
LKLP112ABA bronze accent
LKLP112AOB oil-rubbed bronze, **DAMP**
LKLP112ARS rust, **DAMP**
LKLP112ATS tortoise shell, **DAMP**
 • low-profile light kit
 • amber linen glass
 • pull chain operation
 • 8.5" (H) x 5.2" (W)



LKLP112MMW matte white, **DAMP**
LKLP112WPW pewter
LKLP112WSN satin nickel, **DAMP**
LKLP112WWH white, **DAMP**
 • low-profile light kit
 • white linen glass
 • pull chain operation
 • 8.5" (H) x 5.2" (W)



FITTEES, SHADES AND DECORATIVE GLASS

- Fitters are for use with most Fanimation fans
- Fitter glass sold separately (opposite page)
- Finishes and light bulb requirements vary and are listed for each
- Fitters and light kits rated for both dry and damp locations are noted with DAMP next to the finish
- Light bulbs included
- **UL LISTED**
- Glass and shades should be ordered based on the fitter model selected
- Small glass and shades (G200 series) for use with 2-1/4" opening fitters only; these fitters include F301, F401 and F404
- Glass bowls (G210 and G400 series) require fitters F423 and FW423
- Fabric shade S480 requires fitter F423



F301AB antique brass
F301AZ aged bronze (shown), **DAMP**
F301SN satin nickel, **DAMP**
F301TS tortoise shell, **DAMP**
F301WH white, **DAMP**

- 5" (H) x 8" (W)

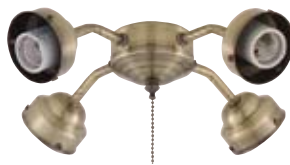

F401AB antique brass (shown)



F401BA bronze accent
F401PW pewter
F401OB oil-rubbed bronze, **DAMP**
F401RS rust, **DAMP**
F401SN satin nickel, **DAMP**
F401TS tortoise shell, **DAMP**
F401WH white, **DAMP**

- 3 1/2" (H) x 13" (W)



F404BL black, **DAMP**
F404MW matte white, **DAMP**
F404SN satin nickel, **DAMP**
F404BA bronze accent
F404PW pewter
F404RS rust, **DAMP**
F404AB antique brass
F404AZ aged bronze, **DAMP**
F404OB oil-rubbed bronze, **DAMP**
F404TS tortoise shell (shown), **DAMP**

- 5" (H) x 12" (W)



F423AB antique brass
F423BA bronze accent
F423AZ aged bronze, **DAMP**
F423BZ bronze, **DAMP**
F423BL black, **DAMP**
F423LT latte, **DAMP**
F423MW matte white, **DAMP**
F423OB oil-rubbed bronze, **DAMP**
F423PW pewter
F423RS shown in rust, **DAMP**
F423SN satin nickel, **DAMP**
F423TB textured black, **DAMP**
F423TS tortoise shell, **DAMP**
F423VZ venetian bronze, **DAMP**
F423WH white, **DAMP**

- 6" (H) x 6" (W)



FW423AZ aged bronze
FW423LT latte
FW423MW matte white
FW423OB oil-rubbed bronze
FW423RS shown in rust
FW423SN satin nickel
FW423TB shown in textured black
FW423TS tortoise shell
FW423WH white

- Uses glass bowls only, sold separately (page 127)
- 7 (H) x 13.5" (W)

Small glass and shades are sold as individual pieces. Example: if you order a four-light fitter, you will need to order four shades. Use with Fanimation fitters F301, F401 and F404 (see opposite page).



G100C
Clear ribbed



G100F
White frosted ribbed



G226
Amber/brown mosaic



G235
Tropical etched glass



G239
Hand-painted parrot



G244
Aged bronze/amber shade



G250
Amber



G256
White frost

Glass bowls should be used with Fanimation fitter FW423 for wet location applications and with Fanimation fitter F423 for dry or damp applications



G210
Tropical bowl



G422
Clear/frosted mosaic



G426
Amber/brown mosaic



G439
Hand-painted parrot



G450
Amber



G451
Powdered amber



G452
Yellow/white swirl



G453
Amber swirl



G456
White frost



G458
Milky white swirl



G459
Rust/cream speckled



G460LA
Amber linen frosted



G460LW
White linen frosted

FABRIC SHADE
Use with Fanimation fitter F423

S480
Beige brocade fabric shade

CONTROLS

- Wall controls include matching face plate
- Control specifications on page 131
- Control options are not available for The Bourbon Street®, The Palmetto®, The Punkah® and The Torrento®
- 220V controls on page 130
- **UL LISTED**

- Included
- Optional
- Optional—Install control in a dry location only

WH—White LA—Light Almond



CW1WH & CW1LA • Fan-only slide control	CW1SWWH & CW1SWLA • Fan slide control with light toggle switch	CW2WH & CW2LA • Fan and light slide control	CW3WH & CW3LA • Fan and light slide control • CW3** -CA for The Caruso™	CW5WH & CW5LA • Two-fan slide control	CW6WH & CW6LA • The Palisade® fan and light slide control	SW24 • The Palisade® receiver unit • For use with TR24** Control
--	--	---	--	---	---	---

Aire Décor®—BP200/210/215/220/225	●	●	●		●	
Aire Décor®—BP230	●	●	●		●	
The Akira™						
The Americana®						
The Andover™						
The Bayhill Collection™ by Lauren Brooks®	●	●	●		●	
The Belleria®	●	●	●		●	
The Benito™						
The Brewmaster™						
The Cancun™—FP8009 & FP8011	●	●	●		●	
The Cancun™ (WET)—FP8012 & FP8016	●	●	●		●	
The Cancun™—FP8042	●	●	●		●	
The Caruso™				●		
The Celano™						
The Cumulos™						
The Edgewood®	●	●	●		●	
Enigma®						
The Extraordinaire®						
Hubbardton Forge® non-uplight						
Hubbardton Forge® uplight						
The Huxley™	●	●	●		●	
The Inlet™						
The Involution™		●	●		●	
The Islander®						
The Keystone™						
The Kubix™						
The Landan™						
The Levon™	●	●	●		●	
The Loreto Bay™						
Louvre®						
The Mariano™						
The Multimax™						
The Old Havana®						
The Palisade®						●
The Quattro™				●		
Sandella®						
The Torto™						
The Ventana™						
The Windpointe®	●	●	●		●	
The Zonix™—FP4620 & FP4630	●	●	●		●	
The Zonix™ (WET)—FP4640	●	●	●		●	

220V CONTROLS

- Wall controls include matching face plate
- Controls are white
- Control specifications on next page
- Control options are not available for The Bourbon Street®, The Palmetto®, The Punkah® and The Torrento®

UL LISTED

- Included
- Optional
- Optional—Install control in a dry location only

WH—White **LA**—Light Almond



C1-220

• 220v fan-only wall control

C2-220

• 220v fan and light wall control

C3-220

• 220v fan-only two-fan wall control

C6-220

• 220v fan and light wall control

CR4WH-220

• 220v fan and light remote

	C1-220	C2-220	C3-220	C6-220	CR4WH-220
The Air Shadow™	●	●	●	●	●
Aire Décor®—BP200 & BP230					
Aire Décor®—BP210 & BP220					
The Akira™					
The Americana®	●	●	●	●	●
The Andover™		●		●	●
The Bayhill Collection™ by Lauren Brooks®	●	●	●	●	●
The Belleria®	●	●	●	●	●
The Benito™					
The Brewmaster™			●	●	
The Cancun™—FP8009 & FP8011					
The Cancun™ (WET)—FP8012 & FP8016					
The Cancun™—FP8042					
The Caruso™					
The Celano™		●		●	●
The Cumulos™					
The Edgewood®	●	●	●	●	●
Enigma®	●	●	●	●	●
The Extraordinaire®					
Hubbardton Forge® non-uplight	●	●	●	●	●
Hubbardton Forge® uplight		●		●	●
The Huxley™	●	●	●	●	●
The Inlet™					
The Involution™	●	●	●	●	●
The Islander®					
The Keystone™					
The Kubix™		●		●	●
The Landan™					
The Levon™					
The Loreto Bay™					
Louvre®					
The Marea™					
The Mariano™					
The Multimax™					
The Old Havana®	●		●		
The Palisade®			●	●	
Sandella®					
The Torto™					
The Ventana™					
The Windpointe®	●	●	●	●	●
The Zonix™—FP4620 & FP4630	●	●	●	●	●
The Zonix™ (WET)—FP4640	●	●	●	●	●



CONTROL SPECS



WH—White



LA—Light Almond



CW1WH & CW1LA

- Fan-only slide control
- 2-wire installation
- 3 fan speeds
- 1.25 amps max. fan load



CW1SWWH & CW1SWLA

- Fan slide control with **light on/off toggle switch**
- 3-wire installation
- 3 fan speeds
- 1.25 amps max. fan load



CW2WH & CW2LA

- Fan and light slide control
- Infinite light levels
- 3-wire installation
- 3 fan speeds
- 1.25 amps max. fan load



CW3WH & CW3LA

- The Palisade® and The Caruso™ fan-only slide control
- CW3**—CA for The Caruso™
- 2-wire installation
- 2 fan speeds
- 5 amps max. fan load



CW5WH & CW5LA

- Fan-only four-to-five-fan slide control
- 2-wire installation
- 3 fan speeds
- 5 amps max. fan load



CW6WH & CW6LA

- The Palisade® fan and light control
- Infinite light levels
- 3-wire installation
- 2 fan speeds



CW40

- Fan-only slide control
- 2-wire installation
- 4 fan speeds
- 1.25 amps max. fan load



CW110WH

- The Extraordinaire™ fan-only slide control
- 2-wire installation
- 3 fan speeds
- 1.25 amps max. fan load



TR20WH & TR20LA

- Reversible fan and light remote
- mounts over switch plate
- 3 fan speeds
- Downlight control



TR22WH & TR22LA

- Reversible fan and light remote
- mounts over switch plate
- 3 fan speeds
- Uplight and downlight control



TR24WH & TR24LA

- Non-reversible fan and light remote
- mounts over switch plate
- 3 fan speeds
- Downlight control



TR28

- The Air Shadow™ fan only
- Reversible fan and light remote
- mounts over switch plate
- 3 fan speeds
- Downlight control
- Demo mode button (cycles fan on/off)



TR29

- DC reversible fan and light remote
- 6 fan speeds
- Downlight control



TR31

- DC reversible fan and light remote
- 6 fan speeds
- Uplight and downlight control



TW30WH & TW30LA

- DC reversible fan and light wall control
- Includes switch plate
- 6 fan speeds
- Downlight control



TW32WH & TW32LA

- DC reversible fan and light wall control
- Includes switch plate
- 6 fan speeds
- Uplight and downlight control



TR33

- The Marea™ fan remote
- mounts over switch plate
- 3 fan speeds



CWRL4WH & CWRL4LA

- Non-reversing fan and light control
- 2-wire installation
- 3 fan speeds
- 1.0 amps max. fan load
- Learn-mode canopy receiver unit for easy set up and 56,000 code settings included
- Infinite light levels up to 190 watts
- Dimmer on/off switch for use with CFL bulbs (dimmer must be turned off)
- May be used with CRL4WH



CRL4WH

- Non-reversing fan and light remote
- Learn-mode canopy receiver unit for easy set up and 56,000 code settings included
- 3 fan speeds
- 1.25 amps max. fan load
- Infinite light levels up to 190 watts
- Dimmer on/off switch for use with CFL bulbs (dimmer must be turned off)
- May be used with CWRL4**



CRL8TS

- Non-reversing touch-screen fan and light remote
- Learn-mode canopy receiver unit for easy set up and 56,000 code settings included
- 3 fan speeds
- Fan timer delay feature
- Delay light feature
- 1.0 amps max. fan load
- Infinite light levels up to 190 watts
- Dimmer on/off switch for use with CFL bulbs (dimmer must be turned off)



CH1WH & CH1LA

- The Old Havana® fan remote
- mounts over switch plate
- 3 fan speeds



RC110

- The Extraordinaire™ non-reversing fan remote
- mounts over switch plate
- 3 fan speeds

220V CONTROLS



C1-220

- 220v non-reversing fan-only wall control
- 100-watt max. fan load



C2-220

- 220v non-reversing fan and light wall control
- 100-watt max. fan load
- 300-watt max. light load



C3-220

- 220v non-reversing fan-only two-fan wall control
- 100-watt max. fan load



C6-220

- 220v non-reversing fan and light wall control
- Controls two fans
- 100-watt max. fan load
- 300-watt max. light load



CR4WH-220

- 220v non-reversing fan and light remote
- 3 fan speeds
- 120-watt max. fan load
- Infinite light levels up to 300-watts
- Canopy receiver unit included

FINISH SWATCHES, DOWNRODS AND ACCESSORIES

FAN FINISHES



DOWNRODS

- Order according to length
- Use finish code to complete the part number
- Downrod information for the Custom Enigma®, The Kubix™ and The Multimax™ can be found on the respective fan pages

*DR1-6**	6" downrod	DR1-36**	36" downrod
DR1-12**	12" downrod	DR1-48**	48" downrod
DR1-18**	18" downrod	DR1-60**	60" downrod
DR1-24**	24" downrod	DR1-72**	72" downrod

*AB, OB & PW only

DOWNROD COUPLERS

- Joins two downrods together for extended lengths
- Use finish code to complete the part number.

DR1-CP** 1" diameter downrod coupler



EXTENSION POLES

- Order according to length
- Use finish code to complete the part number
- For use with The Palisade® only

EP24**	24" downrod	EP48**	48" downrod
EP30**	30" downrod	EP60**	60" downrod
EP36**	36" downrod	EP72**	72" downrod

EXTENSION POLE COUPLERS

- Joins two extension poles together for extended lengths
- Use finish code to complete the part number.
- For use with The Palisade® only

EPCP** Extension pole coupler



SLOPED CEILING KIT



- Includes black hanger ball only
- For use with Fanimation fans purchased *after June 2004*
- Please see individual fan pages to see if this kit is compatible with your fan
- Hanger ball works with current Fanimation canopy and hanger bracket
- Allows for ceiling slope up to 52°
- For use with any length downrod (calculate for blade-to-ceiling clearance before ordering downrod)

SCB52 For use with The Multimax™

SCB1-52 For use with 1" dia. downrods

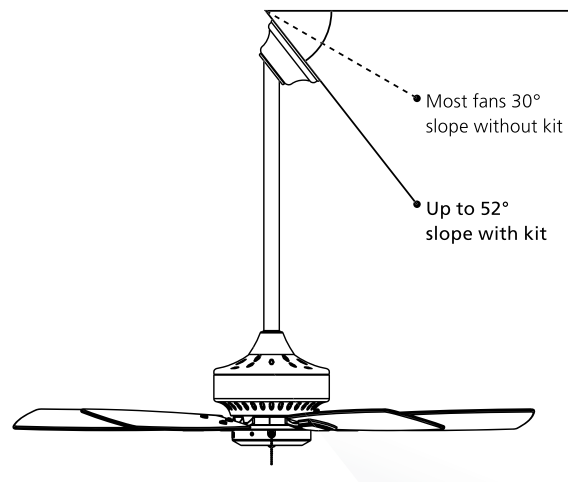

CLOSE-TO-CEILING KIT

- Replaces the hanger bracket and downrod assembly to move your fan closer to the ceiling, creating more head room
- Intended for use with low ceilings.
- Please see individual fan pages to see if this kit is compatible with your fan

- CCK8002AB** antique brass
- CCK8002AZ** aged bronze, **DAMP**
- CCK8002BA** bronze accent
- CCK8002BZ** bronze, **DAMP**
- CCK8002DS** dark smoke, **DAMP**
- CCK8002MH** mahogany, **DAMP**
- CCK8002MW** matte white, **DAMP**
- CCK8002OB** oil-rubbed bronze, **DAMP**
- CCK8002PW** pewter
- CCK8002RS** rust, **DAMP**
- CCK8002SN** satin nickel, **DAMP**
- CCK8002TS** tortoise shell, **DAMP**
- CCK8002WH** white, **DAMP**

• 5.13" (H) x 8" (DIA.)

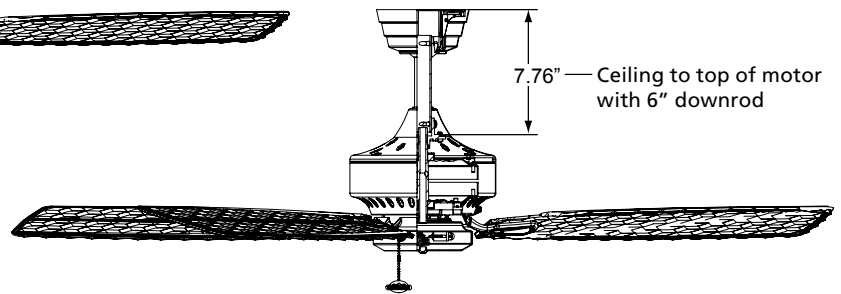
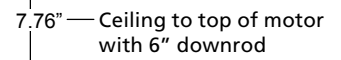
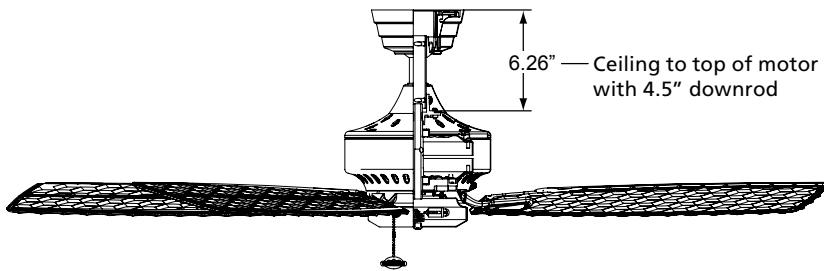
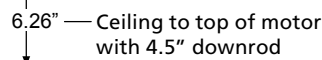
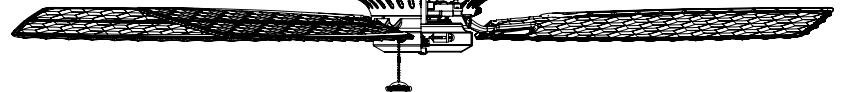
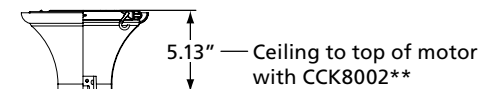

DOWNROD SLEEVE

DRS24TR

- Tropical downrod sleeve
- 16" tall
- Requires minimum 24" downrod or extension pole

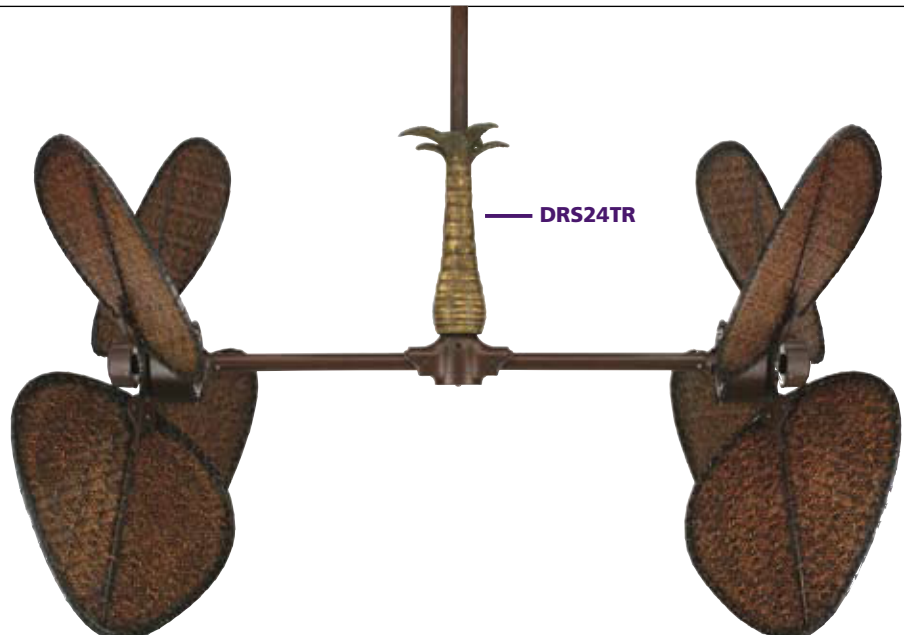

— DRS24TR

BLADES

- Blades listed come in sets of five (5) except those for The Brewmaster®—two (2), The Palisade®—eight (8) and The Caruso™—ten (10).
- Blades should be ordered based on the fan model selected
- Blade sets vary based on catalog number and are specific to fan models
- Some blade catalog numbers require fan finish codes
- Due to the nature of the materials and the hand-crafted processes; stain, color, texture and shading will vary

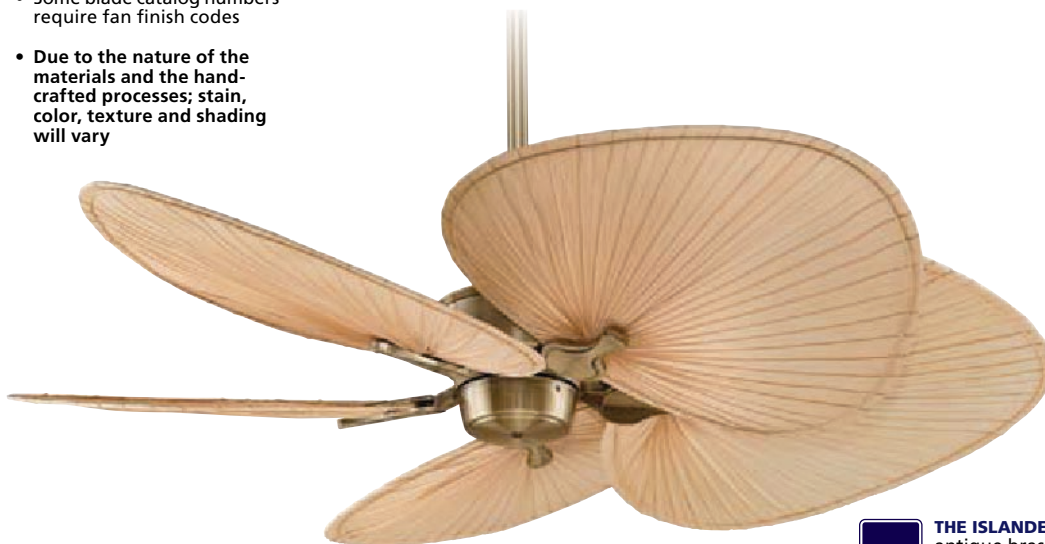
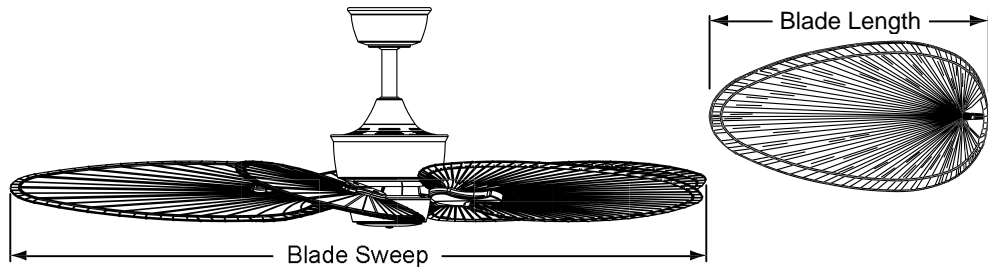

The Americana®	
The Belleria®	
The Bourbon Street®	
The Brewmaster®	
The Caruso™	
The Islander®	
Louvre®	
The Palisade®	
The Palmetto®	
The Punkah®	
Sandella®	
The Torrento®	
The Windpointe® Five-blade	

*Wood blades for The Brewmaster® are sold on page 65



THE ISLANDER: MAD3250AB (1)
antique brass assembly
BLADE SET: ISP1 (1)
22" natural wide oval palm blade



DRY LOCATION RATED ONLY

The Americana®	B5300WA	B6000CY	B6000MH	B6000MP	B6000TK	B6030CY	B6030MH	B6030MP	B6030TK	FP1018	
The Belleria®	B5300WA	B6000CY	B6000MH	B6000MP	B6000TK	B6030CY	B6030MH	B6030MP	B6030TK		
The Bourbon Street®	B5300WA	B6000CY	B6000MH	B6000MP	B6000TK	B6030CY	B6030MH	B6030MP	B6030TK	FP1018	
The Brewmaster®											
The Caruso™											
The Islander®	B5300WA	B6000CY	B6000MH	B6000MP	B6000TK	B6030CY	B6030MH	B6030MP	B6030TK		
Louvre®	B5300WA	B6000CY	B6000MH	B6000MP	B6000TK	B6030CY	B6030MH	B6030MP	B6030TK		
The Palisade®											
The Palmetto®											
The Punkah®											
Sandella®	B5300WA	B6000CY	B6000MH	B6000MP	B6000TK	B6030CY	B6030MH	B6030MP	B6030TK		
The Torrento®	B5300WA	B6000CY	B6000MH	B6000MP	B6000TK	B6030CY	B6030MH	B6030MP	B6030TK		
The Windpointe® Five-blade	B5300WA	B6000CY	B6000MH	B6000MP	B6000TK	B6030CY	B6030MH	B6030MP	B6030TK		

*Wood blades for The Brewmaster® are sold on page 65



- 22" long
- 52" sweep
- natural
- palm leaf

(U.S. TM Reg # 2,812,018)



- 18" long
- 44" sweep
- natural
- palm leaf

(U.S. TM Reg # 2,812,018)



- 22" long
- 52" sweep
- natural
- palm leaf

(U.S. TM Reg # 2,812,018)



- 18" long
- 44" sweep
- natural
- palm leaf

(U.S. TM Reg # 2,812,018)



- 22" long
- 52" sweep
- red/brown
- palm leaf

(U.S. TM Reg # 2,812,018)



- 22" long
- 52" sweep
- red/brown
- palm leaf

(U.S. TM Reg # 2,812,018)

DRY LOCATION RATED ONLY

ISP1	ISP2	ISP4	ISP5	ISP1RB	ISP4RB
ISP1	ISP2	ISP4	ISP5	ISP1RB	ISP4RB
ISP1	ISP2	ISP4	ISP5	ISP1RB	ISP4RB
BMP1					
	CAISP2	CAISP4			CAISP4RB
ISP1	ISP2	ISP4	ISP5	ISP1RB	ISP4RB
ISP1	ISP2	ISP4	ISP5	ISP1RB	ISP4RB
PAP1	PAP2			PAP1RB	
	PMP2**				
PUP1	PUP2			PUP1RB	
ISP1	ISP2	ISP4	ISP5	ISP1RB	ISP4RB
ISP1	ISP2	ISP4	ISP5	ISP1RB	ISP4RB
ISP1	ISP2	ISP4	ISP5	ISP1RB	ISP4RB



LOUVRE: MAD3255PW (1)
pewter assembly
BLADE SET: B5330WA (1)
22" walnut soft rounded
carved wood blade



- 22" long
- 52" sweep
- walnut
- wood



- 22" long
- 52" sweep
- walnut
- wood



- 22" long
- 52" sweep
- walnut
- wood



- 22" long
- 52" sweep
- walnut
- wood



- 22" long
- 52" sweep
- walnut
- wood



- 26" long
- 60" sweep
- walnut
- wood



- 26" long
- 60" sweep
- walnut
- wood



- 26" long
- 60" sweep
- walnut
- wood



- 26" long
- 60" sweep
- walnut
- wood



- 26" long
- 60" sweep
- walnut
- wood

DRY LOCATION RATED ONLY

B5260WA	B5270WA	B5280WA	B5310WA	B5330WA	B6060WA	B6070WA	B6080WA	B6110WA	B6130WA
B5260WA	B5270WA	B5280WA	B5310WA	B5330WA	B6060WA	B6070WA	B6080WA	B6110WA	B6130WA
B5260WA	B5270WA	B5280WA	B5310WA	B5330WA	B6060WA	B6070WA	B6080WA	B6110WA	B6130WA
B5260WA	B5270WA	B5280WA	B5310WA	B5330WA	B6060WA	B6070WA	B6080WA	B6110WA	B6130WA
B5260WA	B5270WA	B5280WA	B5310WA	B5330WA	B6060WA	B6070WA	B6080WA	B6110WA	B6130WA
B5260WA	B5270WA	B5280WA	B5310WA	B5330WA	B6060WA	B6070WA	B6080WA	B6110WA	B6130WA
B5260WA	B5270WA	B5280WA	B5310WA	B5330WA	B6060WA	B6070WA	B6080WA	B6110WA	B6130WA

BLADES

- Blades listed come in sets of five (5) except those for The Palisade—eight (8) and The Caruso—ten (10).
- Blades should be ordered based on the fan model selected
- Blade sets vary based on catalog number and are specific to fan models
- Some blade catalog numbers require fan finish codes
- Due to the nature of the materials and the hand-crafted processes; stain, color, texture and shading will vary



· 22" long
· 52" sweep
· antique
· woven bamboo
(U.S. Patent # D450,380)



· 18" long
· 44" sweep
· antique
· woven bamboo
(U.S. Patent # D450,380)



· 22" long
· 52" sweep
· antique
· woven bamboo
(U.S. Patent # D437,406)



· 18" long
· 44" sweep
· antique
· woven bamboo
(U.S. Patent # D437,406)

DAMP & DRY LOCATION RATED ONLY

The Americana®	ISD1A	ISD2A	ISD4A		
The Belleria®	ISD1A	ISD2A	ISD4A		
The Bourbon Street®	ISD1A	ISD2A	ISD4A		
The Brewmaster®			BMD4A		
The Caruso™		CAISD2A	CAISD4A	CAISD5A	
The Islander®	ISD1A	ISD2A	ISD4A		
Louvre®	ISD1A	ISD2A	ISD4A		
The Palisade®	PAD1A	PAD2A			
The Palmetto®		PMD2A**			
The Punkah®	PUD1A	PUD2A			
Sandella®	ISD1A	ISD2A	ISD4A		
The Torrento®	ISD1A	ISD2A	ISD4A		
The Windpointe® Five-blade	ISD1A	ISD2A	ISD4A		

CHINESE PALM BLADE

- For use with The Islander® Louvre® and Sandella®
- Composite natural finish Chinese palm blade with fan-finish-matched blade arm
- 52" Blade Sweep
- Sold in sets of 5



· 22" long
· 52" sweep
· natural palm
· composite



· 22" long
· 52" sweep
· dark mango
· composite



· 22" long
· 52" sweep
· light mango
· composite



· 22" long
· 52" sweep
· antique
· composite
(U.S. Patent # D450,380)



· 22" long
· 52" sweep
· antique
· composite
(U.S. Patent # D437,406)



· 18" long
· 44" sweep
· antique
· composite
(U.S. Patent # D437,406)

DRY, DAMP & WET LOCATION RATED

The Americana®	BPW6090DNA	BPW5290DM	BPW5290LM	BPD1A	BPD4A	BPD5A
The Belleria®	BPW6090DNA	BPW5290DM	BPW5290LM	BPD1A	BPD4A	BPD5A
The Bourbon Street®	BPW6090DNA	BPW5290DM	BPW5290LM	BPD1A	BPD4A	BPD5A
The Brewmaster®						
The Caruso™					CABPD4A	CABPD5A
The Islander®	BPW6090DNA	BPW5290DM	BPW5290LM	BPD1A	BPD4A	BPD5A
Louvre®	BPW6090DNA	BPW5290DM	BPW5290LM	BPD1A	BPD4A	BPD5A
The Palisade®				PAD1A		
The Palmetto®						
The Punkah®						
Sandella®	BPW6090DNA	BPW5290DM	BPW5290LM	BPD1A	BPD4A	BPD5A
The Torrento®	BPW6090DNA	BPW5290DM	BPW5290LM	BPD1A	BPD4A	BPD5A
The Windpointe® Five-blade	BPW6090DNA	BPW5290DM	BPW5290LM	BPD1A	BPD4A	BPD5A



· 22" long
· 52" sweep
· antique
· woven bamboo
(U.S. Patent # D434,134)



· 22" long
· 52" sweep
· clear
· woven bamboo
(U.S. Patent # D450,380)



· 22" long
· 52" sweep
· clear
· woven bamboo
(U.S. Patent # D437,406)



· 22" long
· 52" sweep
· clear
· woven bamboo
(U.S. Patent # D434,134)



· 20.5" long
· 49" sweep
· cherry
· composite



· 20" long
· 48" sweep
· cherry
· composite



· 20" long
· 48" sweep
· mahogany
· composite



· 20" long
· 48" sweep
· teak
· composite

DRY & DAMP LOCATION RATED ONLY

DRY, DAMP & WET LOCATION RATED

	ISD7A	ISD1C	ISD4C	ISD7C	BPW10CY	BPW20CY	BPW20MH	BPW20TK
	ISD7A	ISD1C	ISD4C	ISD7C	BPW10CY	BPW20CY	BPW20MH	BPW20TK
	ISD7A	ISD1C	ISD4C	ISD7C	BPW10CY	BPW20CY	BPW20MH	BPW20TK
	CAISD7A		CAISD4C		CABPW10CY			
	ISD7A	ISD1C	ISD4C	ISD7C	BPW10CY	BPW20CY	BPW20MH	BPW20TK
	ISD7A	ISD1C	ISD4C	ISD7C	BPW10CY	BPW20CY	BPW20MH	BPW20TK
		PAD1C						
		PUD1C						
	ISD7A	ISD1C	ISD4C	ISD7C	BPW10CY	BPW20CY	BPW20MH	BPW20TK
	ISD7A	ISD1C	ISD4C	ISD7C	BPW10CY	BPW20CY	BPW20MH	BPW20TK
	ISD7A	ISD1C	ISD4C	ISD7C	BPW10CY	BPW20CY	BPW20MH	BPW20TK

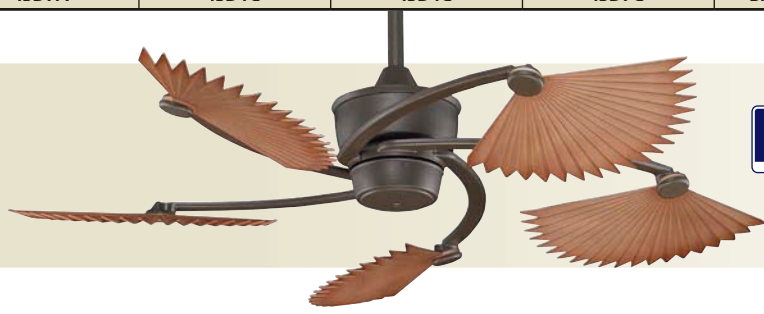

THE ISLANDER: MAD32500B (1)
oil-rubbed bronze assembly
BLADE SET: BPW52400B (1)
all-weather composite natural finish chinese palm blade with oil-rubbed bronze blade arm



· 22" long
· 52" sweep
· white
· composite
(U.S. Patent #D437,406)



· 22" long
· 52" sweep
· black
· composite
(U.S. Patent #D437,406)



· 22" long
· 52" sweep
· natural palm
· composite
(U.S. TM Reg # 2,812,018)



· 22" long
· 52" sweep
· natural palm
· composite
(U.S. Patent # D433,118)



· 22" long
· 52" sweep
· brown/red
· composite
(U.S. TM Reg # 2,812,018)



· 22" long
· 52" sweep
· brown/red
· composite
(U.S. Patent # D433,118)



· 22" long
· 52" sweep
· green
· composite
(U.S. Patent # D433,118)

DRY, DAMP & WET LOCATION RATED

	BPD4MW	BPD4BL	BPP1	BPP4TN	BPP1BR	BPP4BR	BPP4GR
	BPD4MW	BPD4BL	BPP1	BPP4TN	BPP1BR	BPP4BR	BPP4GR
	BPD4MW	BPD4BL	BPP1	BPP4TN	BPP1BR	BPP4BR	BPP4GR
				CABPP4TN		CABPP4BR	CABPP4GR
	BPD4MW	BPD4BL	BPP1	BPP4TN	BPP1BR	BPP4BR	BPP4GR
	BPD4MW	BPD4BL	BPP1	BPP4TN	BPP1BR	BPP4BR	BPP4GR
	BPD4MW	BPD4BL	BPP1	BPP4TN	BPP1BR	BPP4BR	BPP4GR
	BPD4MW	BPD4BL	BPP1	BPP4TN	BPP1BR	BPP4BR	BPP4GR
	BPD4MW	BPD4BL	BPP1	BPP4TN	BPP1BR	BPP4BR	BPP4GR

FUNCTION.
INNOVATION.
QUALITY.

FANIMATION®

10983 Bennett Parkway, Zionsville, Indiana 46077

 fanimation.com

 facebook.com/fanimation

 888.567.2055

 twitter.com/fanimation

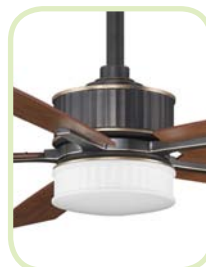

DCmotor
CONSUMES UP TO 70% LESS ENERGY
available with select fans



Member of the American Lighting Association



©2011 Fanimation, Inc.
Products are subject to change.

LTFC
January 2011