

D1-D2

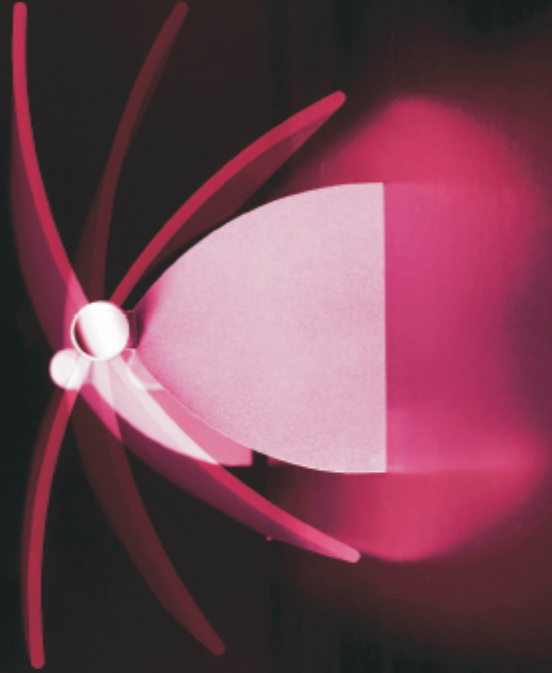

Z ZANEEN.

DECORATIVE

D1-D2

Z ZANEEN

DECORATIVE

Z ZANEEN.

DECORATIVE

GENERAL
CATALOG

D1-D2

D1

- | | | | |
|----|-----------|----|----------|
| 4 | AERO | 48 | SERA |
| 8 | CYCLOS | 54 | VISION |
| 14 | SPOOL | 60 | FLORA |
| 20 | FLY | 63 | NAUTILUS |
| 24 | TAMBURO | 64 | BRICK |
| 29 | CUNA | 66 | ECO |
| 31 | NAPOLEONA | 68 | HAPPY |
| 32 | TRATTO | 70 | BOREALE |
| 34 | SPACE | 72 | RHA |
| 38 | BLUES | 74 | FLAT-Q |
| 40 | INTERNOS | 77 | FLAT-R |
| 44 | BANALE | 80 | AI-PI |
| 46 | EQUAL | 86 | TEKNA |

Aero



Cyclos



Spool



Banale



Flat-Q



Ai-Pi



D2

- | | | | |
|-----|-----------|-----|---------|
| 88 | BAAN | 124 | HOT |
| 90 | BRIGHT | 126 | GEA |
| 92 | DUPLEX | 128 | DOME |
| 95 | OLYMPIA | 133 | EOS |
| 98 | EMY | 135 | SQUARE |
| 101 | GAIA | 137 | RONNI |
| 103 | OLLY | 138 | JOLE |
| 107 | TWIST | 140 | LUNA |
| 109 | ALTEA | 141 | VIDEO |
| 113 | LINA | 142 | BELLA |
| 114 | ERSILIA | 144 | SORRISO |
| 116 | PRIMA | 145 | OMNI |
| 118 | ROCK | 146 | RING |
| 120 | FLUONIGHT | 147 | POCKET |

Vision

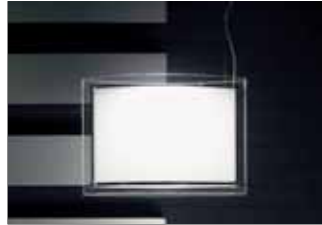

Happy



Duplex



Equal



Bright





Baan



Opal and red triplex blown glass pendant and wall lamp. Internal amber for the pendant. Upper glass detail of the wall lamp available in red, amber or white.

Série de lampes à lumière diffuse. Structure en métal laqué. Diffuseur en verre soufflé opalin ou doublé rouge satiné. Les détails supérieurs en verre peuvent être selon le choix dans les coloris : rouge, vert, ambre ou blanc. Dans les versions « rouge », le détail est blanc.

Serie de lámparas con luz difusa. Estructura de metal pintado. Difusor de vidrio soplado opalino o enfundado rojo satinado. Los detalles superiores de vidrio se pueden elegir en los siguientes colores: rojo, verde, ámbar o blanco. En la versión en rojo el detalle es blanco.

MODEL	CATEGORY	FINISH	MAX WATTAGE	LAMP TYPE
D1-1048	PENDANT	- RED	2x75 W	E26 T10 
D1-1049	PENDANT	- WHITE / AMBER	2x75 W	E26 T10 
D1-3077	WALL	- WHITE	1x100 W	E26 BT15 

D1-1048
D1-1049

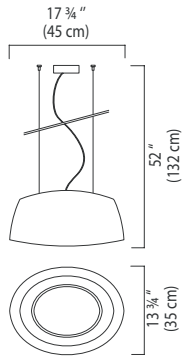
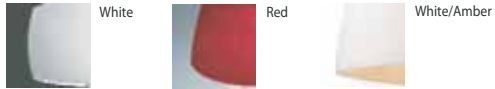

D1-3077

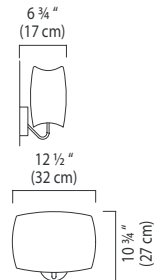







Outer body made of white or silver gray powder coated aluminum.
Inner diffuser made of glossy opaline methacrylate.

Corps externe en aluminium laqué à la peinture en poudre dans les coloris blanc ou gris argent et partie interne diffusante en méthacrylate opalin brillant.

Cuerpo externo de aluminio barnizado a polvo en color blanco o gris plateado, y parte interna difusora de metacrilato opalino brillante.

MODEL	CATEGORY	FINISH	MAX WATTAGE	LAMP TYPE
D1-1030	PENDANT	- WHITE	1x40 W	2GX13 T5 CIRCLINE 
D1-1031	PENDANT	- SILVER GRAY	1x40 W	2GX13 T5 CIRCLINE 
D1-1032	PENDANT	- WHITE	5x18 W	G24q2 T4 
D1-1033	PENDANT	- SILVER GRAY	5x18 W	G24q2 T4 
D1-2025	CEILING / WALL	- WHITE	1x40 W	2GX13 T5 CIRCLINE 
D1-2026	CEILING / WALL	- SILVER GRAY	1x40 W	2GX13 T5 CIRCLINE 

D1-1030
D1-1031

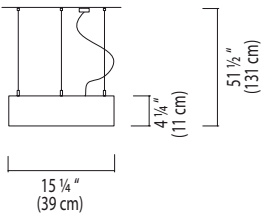

White



Silver gray

D1-2025
D1-2026

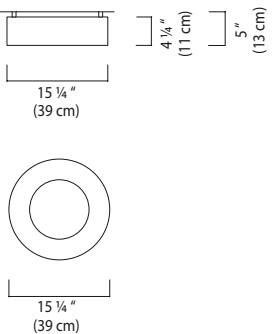

D1-1032
D1-1033

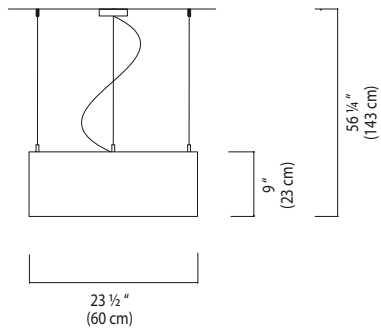









Reflectors in titanium
gray coated aluminum.
Colored methacrylate
filters in purple red, acid green and
cobalt blue. Pendant includes
a satin-finish glass diffuser.

Série de lampes à lumière réfléchie et
diffuse. Réflecteurs en aluminium
laqué blanc ou gris titane. Filtrés
colorés en méthacrylate dans les
coloris rouge pourpre, vert acide et
bleu cobalt.
La suspension est
réalisée avec un verre diffusant satiné.

Serie de lámparas de luz difusa
y refleja. Reflectores de aluminio
barnizado blanco o gris titano.
Filtros de metacrilato de color rojo
púrpura, verde ácido y azul cobalto.
La luminaria colgante está equipada
con un vidrio difusor satinado.

MODEL	CATEGORY	FINISH	MAX WATTAGE	LAMP TYPE
D1-1037	PENDANT	- TITANIUM GRAY	1x150 W	E26 BT15 
D1-4014	TABLE	- TITANIUM GRAY	1x150 W	E26 BT15 
D1-4016	TABLE	- TITANIUM GRAY	1x150 W	E26 BT15 
D1-4018	FLOOR	- TITANIUM GRAY	1x150 W	E26 BT15 

D1-4014

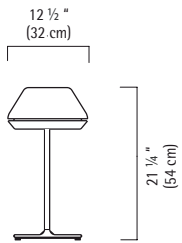

Colored filters:
Green filter D1-9002
Blue filter D1-9004
Red filter D1-9006

D1-4016

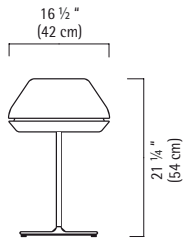

Colored filters:
Green filter D1-9003
Blue filter D1-9005
Red filter D1-9007



Titanium gray

D1-4018

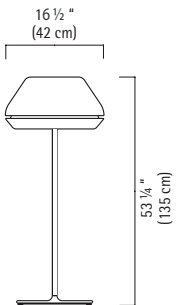

Colored filters:
Green filter D1-9003
Blue filter D1-9005
Red filter D1-9007

D1-1037

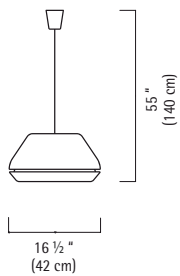

Colored filters:
Green filter D1-9003
Blue filter D1-9005
Red filter D1-9007

Filter to be selected from the following options.







Diffused lighting in wall mount or pendant.
Painted metal and chromed finishes. Satined white glass diffuser.

Suspensions et appliques à lumière orientable. Structure en métal verni avec des particuliers de rotation chromés. Réflecteurs en verre satiné blanc. Ballast électronique.

Colgantes y appliques con luz orientable. Estructura de metal barnizado con detalles de rotación cromados. Reflectores de vidrio blanco satinado. Alimentación electrónica.

Adjustable glass diffusers.

MODEL	CATEGORY	FINISH	MAX WATTAGE	LAMP TYPE
D1-1046	PENDANT	- WHITE	2x24 W	G5 T5
D1-1047	PENDANT	- WHITE	2x39 W	G5 T5
D1-3075	WALL	- WHITE	1x100 W	R7s T3Q/3(79mm)
D1-3076	WALL	- WHITE	1x24 W	G5 T5

D1-1046

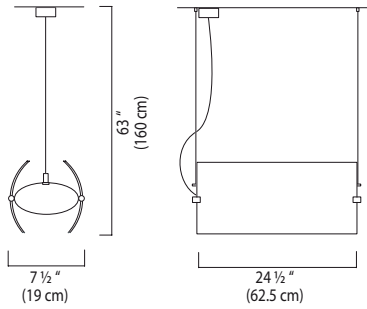

D1-3075

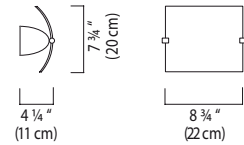

D1-3076

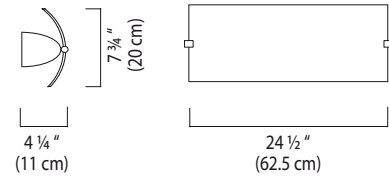

D1-1047

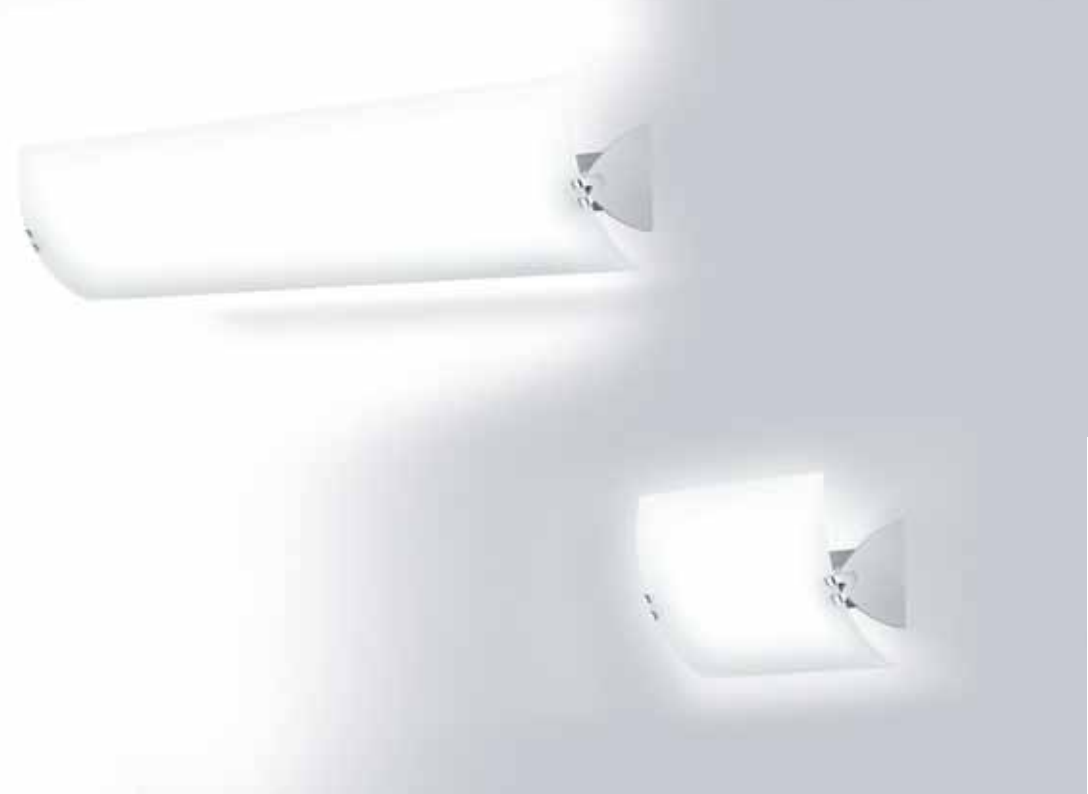
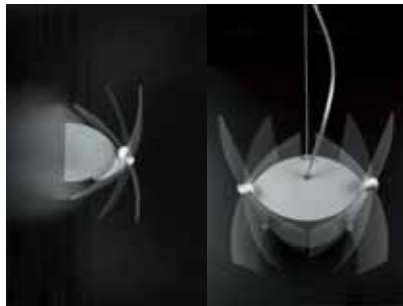
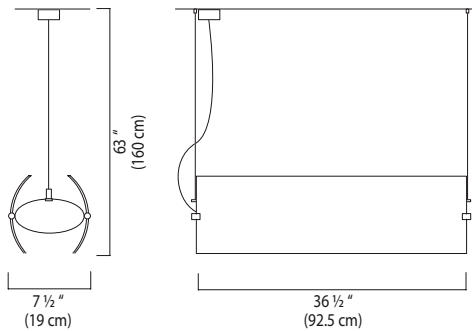



design Roberto Favaretto **Tamburo**

Direct light and direction-adjustable lamp series. Pressed metal round structure, chrome. Finishing, Orange, blue and transparent filters to complete the lamp. Gloss opal acrylic diffuser. Hanging lamp with height-adjustable chromed stem.

Série de lampes à lumière directe et orientable. Structure du corps circulaire en métal chromé. Filtres colorés orange, bleu ou transparent. Diffuseur en méthacrylate opalin brillant. Suspension avec tige chromée réglable en hauteur. Éléments de support pour la lampe mural, de sol et suspension en finition laqué gris.

Serie de lámparas de luz directa y orientable. Estructura del cuerpo circular de metal cromado completa con filtros de color anaranjado, azul o transparente. Difusor de metacrilato opalino con brillo. Suspensión con pie cromado regulable en altura.

MODEL	CATEGORY	FINISH	MAX WATTAGE	LAMP TYPE
D1-1038	PENDANT	- CHROME	1x40 w	2GX13 T5 CIRCLINE
ADA D1-2044	CEILING / WALL	- CHROME	1x55 W	2GX13 T5 CIRCLINE
D1-2059	CEILING / WALL	- GRAY PAINTED	1x40 + 1x22 W	2GX13 T5 CIRCLINE

D1-2044 ADA

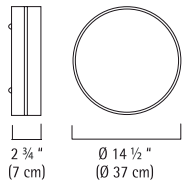

Colored filters
Transparent D1-9008
Blue D1-9009
Orange D1-9010

D1-1038

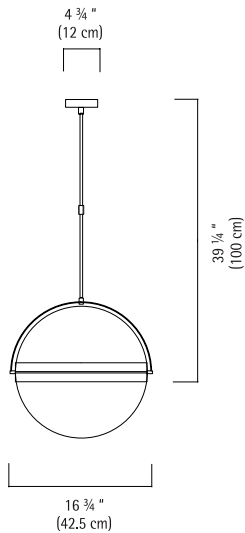

Colored filters
Transparent D1-9008
Blue D1-9009
Orange D1-9010



D1-2059

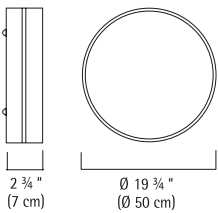

Colored filters
Transparent D1-9011
Blue D1-9012
Orange D1-9013

Filter to be selected from the following options.

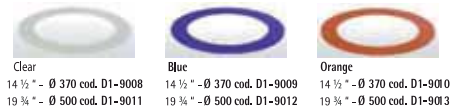

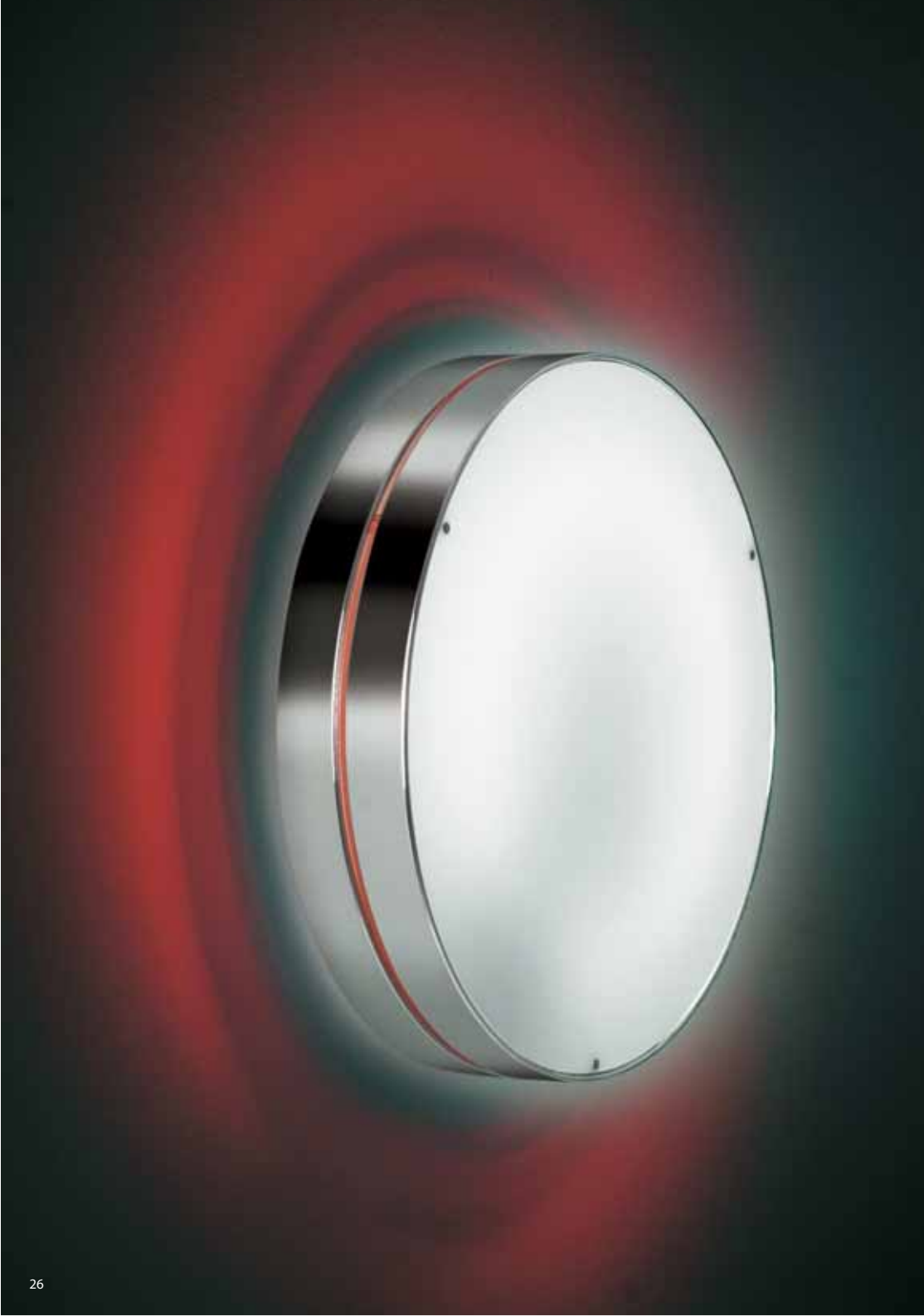

Diffuse pendant in natural plate micro-perforated plate with internal blown glass diffuser. Anti glare louvre.

Suspension à lumière diffuse et directe en tôle micro perforée peinte en naturelle. Diffuseur interne en verre soufflé opale. Lamelles pare-lumière.

Suspensión con luz difusa y directa en chapa metálica microperforada lacada natural. Difusor interno en vidrio soplado opal. Láminas-franjas de la luz.

MODEL	CATEGORY	FINISH	MAX WATTAGE	LAMP TYPE
D1-1000	PENDANT	- NATURAL PLATE	1x100 W	E26 BT15 

D1-1000

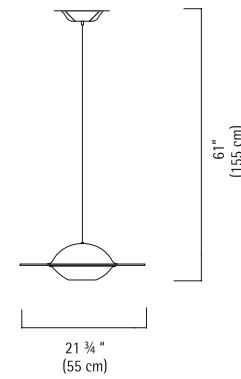

Natural plate





Diffuse lighting pendant.
Satin glass diffuser.
Interchangeable thermoplastic fasteners available in clear, aqua, yellow and red. Four of each color are included in the packaging.
White micro-perforated ceiling plate.

Suspension à lumière diffuse.
Diffuseur en verre satiné, éléments de fixation au verre en matériel thermoplastique, interchangeable et fournis dans les coloris: transparent, aigue-marine, jaune et rouge.
Fixation au plafond en tôle micro perforée peinte en blanc.

Suspensión con luz difusa. Difusor de vidrio satinado, fijadores del vidrio en termplástico intercambiables en varios colores: transparente, agua marina, amarillo y rojo. Soporte a techo en chapa metálica microperforada lacada blanca.

MODEL	CATEGORY	FINISH	MAX WATTAGE	LAMP TYPE
D1-1026	PENDANT	- SATIN GLASS	1x150 W	R7s T3Q (119 mm)

D1-1026

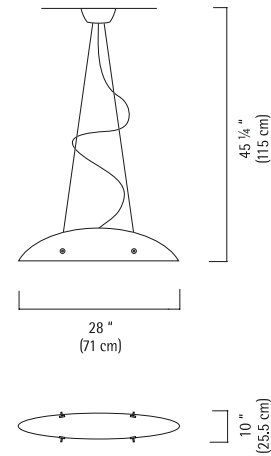

All fastener color options are included

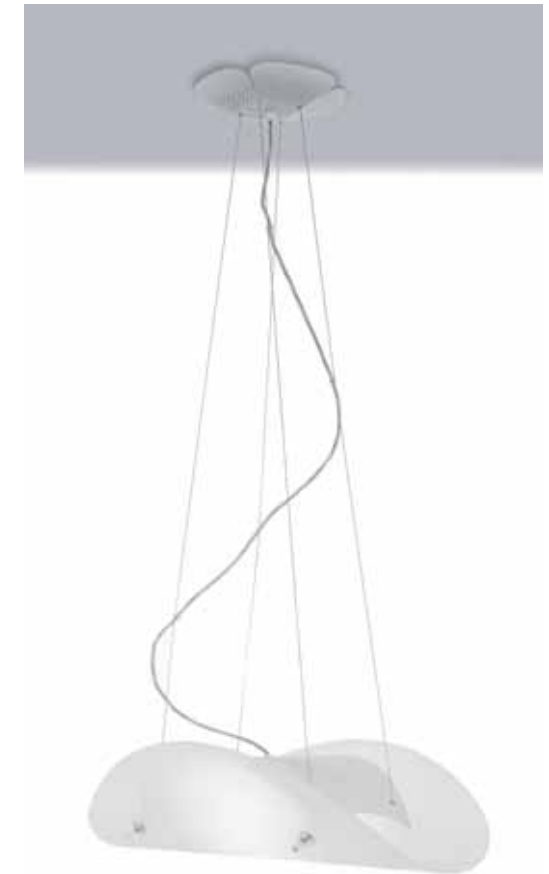
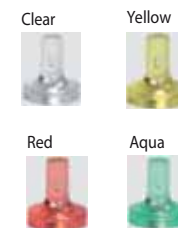

Diffuse lighting wall mount.
Matte chrome frame.
Opal satined blown glass
diffuser.

Applique à lumière diffuse.
Structure en métal chromé
mat. Diffuseur en verre soufflé
opale satiné.

Lámpara de pared con luz
difusa. Estructura en metal
cromado opaco. Difusor en vidrio
soplado opal satinado.

MODEL	CATEGORY	FINISH	MAX WATTAGE	LAMP TYPE
D1-3001	WALL	- MATTE CHROME	1x150 W	R7s T3Q (119 mm)
D1-5015	WALL	- MATTE CHROME	1x24 W	G5 T5

D1-3001

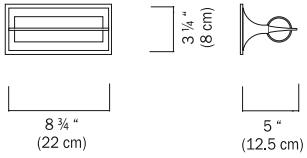

D1-5015

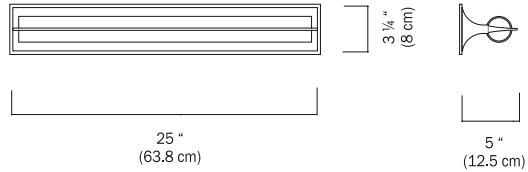

Matte chrome



Diffuse light, ceiling mount or pendant.
Sanded satin glass diffuser.
Polished, aluminum painted
glass support for star light reflection.
Interchangeable thermoplastic
fasteners available in: clear, aqua,
yellow and red. Four of each color
are included in the packaging.

Plafonnier ou suspension à lumière
diffuse. Diffuseur en verre satiné
sablé. Support sur lequel repose le
verre en tôle emboutie peinte
aluminium brillant, en étoile pour
réfléchir la lumière. Éléments de
fixation du diffuseur en matériel
thermoplastique,
interchangeables et fournis
dans les coloris: transparent,
aigue-marine, jaune et rouge.

Lámpara de techo o suspensión
con luz difusa.
Difusor en vidrio arenado.
Soporte de apoyo del vidrio en chapa
prensada, lacada aluminio brillante,
para el reflejo de la luz a rayos.
Fijadores del difusor en termoplástico
provisto en los colores: transparente,
agua marina, amarillo y rojo.

MODEL	CATEGORY	FINISH	MAX WATTAGE	LAMP TYPE
D1-1003	PENDANT	- SATIN GLASS	1x150 W	R7s T3Q (119 mm)
	CANOPY LIGHT	- SATIN GLASS	1x25 W	G9 T4
ADA D1-2000	CEILING / WALL	- SATIN GLASS	1x150 W	R7s T3Q (119 mm)

D1-1003

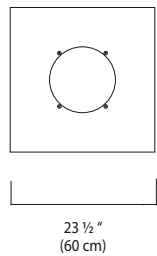
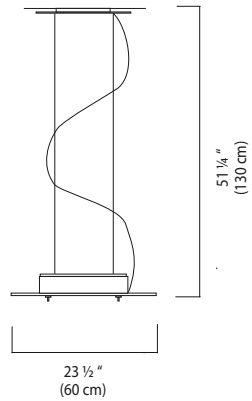

D1-2000 ADA

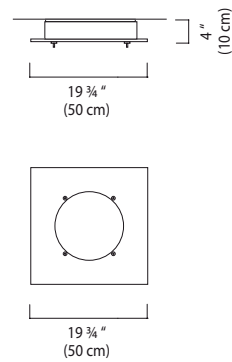

All fastener color options
are included.







design Roberto Favaretto **Blues**

Direct and diffuse lighting series.
Satinéd blown glass diffuser.
Brushed nickel external
ceiling rose and glass holder
structure. Nickel-coated metal
internal diffuser structure.

Série de lampes à lumière directe
et diffuse. Diffuseur en verre soufflé
transparent satiné. Rosace et support
du verre constitués d'une structure
en métal dont la partie externe
est en nickel brossé. Structure
interne du support du diffuseur
en métal nickelé.

Serie de lámparas con luz difusa
y directa. Difusor en vidrio
soplado transparente satinado.
Estructura metálica del soporte
y de los fijadores exteriores
en níquel cepillado. Estructura
interna del soporte al difusore
en níquel.

MODEL	CATEGORY	FINISH	MAX WATTAGE	LAMP TYPE
D1-1006	PENDANT	- BRUSHED NICKEL	1x100 W	E26 A19 
D1-3006	WALL	- BRUSHED NICKEL	1x60 W	E12 G16 ½ 

D1-1006



Nickel

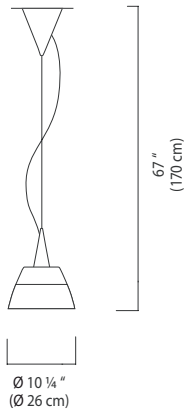

D1-3006

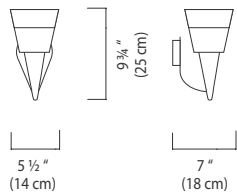





design Roberto Favaretto

Internos

Diffuse lighting pendant and wall lamp mount. Double ribbon diffuser in curved, satinéd glass inserted in a chrome metal structure.

Suspension et applique à lumière diffuse. Double diffuseur à ruban en verre satinéd et courbé fixé sur une structure métallique chromée.

Suspensión y lámpara de pared con luz difusa. Doble difusor a cinta en vidrio satinado curvado introducido en una estructura metálica en o cromada.

MODEL	CATEGORY	FINISH	MAX WATTAGE	LAMP TYPE
D1-1001	PENDANT	- CHROME	5x40 W	G9 T4 
ADA D1-5000	WALL	- CHROME	2x40 W	G9 T4 
ADA D1-5003	WALL	- CHROME	3x40 W	G9 T4 
ADA D1-5005	WALL	- CHROME	5x40 W	G9 T4 

D1-5000 ADA

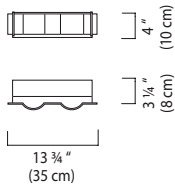

D1-5003 ADA

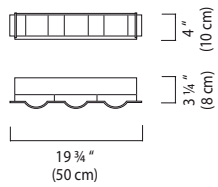

D1-5005 ADA

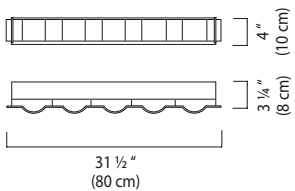

D1-1001

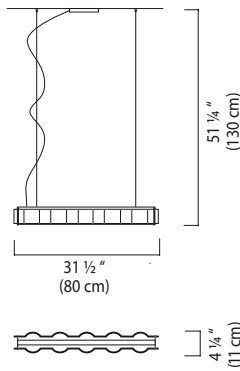

Chrome





design Giandomenico Belotti - Carlo Forcolini **Banale**

Diffuse light eight-globe pendant in satin opal blown glass.
Matte chrome metal tubular body.
White painted metal holder.
Each globe threads on to clear thermoplastic fitting.

Suspension à lumière diffuse à huit globes en verre soufflé opale satiné.
Corps tubulaire en métal chromé mat.
Structure interne en métal peint en blanc. Mécanisme permettant de fixer et d'enlever chaque globe en matériel thermoplastique transparent.

Suspensión con luz difusa con ocho esferas de vidrio soplado opal satinado.
Cuerpo tubular en metal cromado opaco. Estructura interna en metal lacado blanco. Mecanismo de fijación de cada una de las esferas en termoplástico transparente.

MODEL	CATEGORY	FINISH	MAX WATTAGE	LAMP TYPE
D1-1010	PENDANT	- MATTE CHROME	8x60 W	E26 A19 

D1-1010

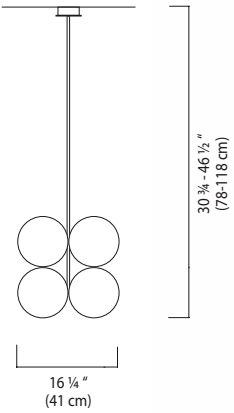

White



design Roberto Favaretto **Equal**

Direct and diffused light, wall and ceiling mount series. Inner structure made of white-coated metal and silk-screened glass diffuser. Frames available in two finishes: chrome and brushed nickel.

Série de lampes murales et de plafonniers à lumière directe et diffuse, structure interne en métal laqué blanc, diffuseur en verre sérigraphie, cadres disponibles en deux finitions. Chrome brillant et nickel brossé.

Serie de luminarias de pared y de techo con luz directa y difusa, estructura interna de metal barnizado blanco, difusor de vidrio serigrafado, marcos disponibles con dos diferentes acabados: cromo brillo y níquel cepillado.

MODEL	CATEGORY	FINISH	MAX WATTAGE	LAMP TYPE
ADA D1-2035	CEILING / WALL	- BRUSHED NICKEL	2x18 W	2G11 T4
ADA D1-2036	CEILING / WALL	- CHROME	2x18 W	2G11 T4
ADA D1-2039	CEILING / WALL	- BRUSHED NICKEL	2x24 W	2G11 T4
ADA D1-2040	CEILING / WALL	- CHROME	2x24 W	2G11 T4

D1-2035 **ADA**
D1-2036 **ADA**

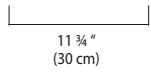
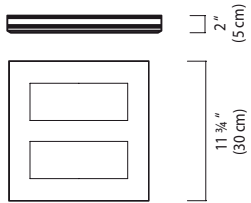



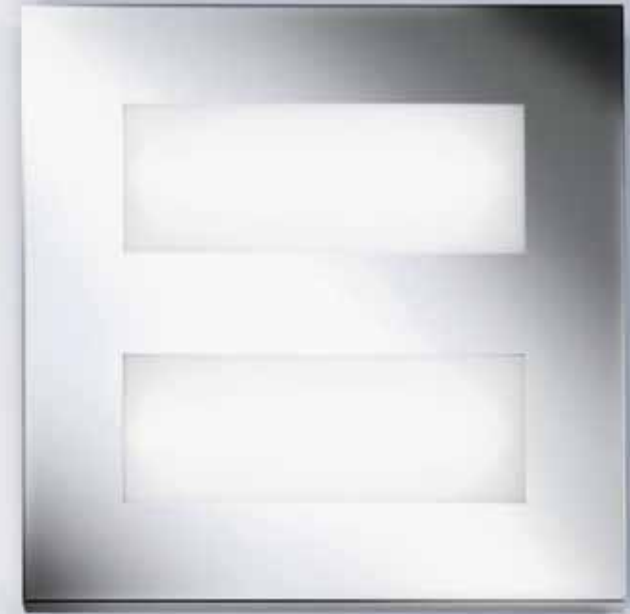
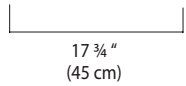
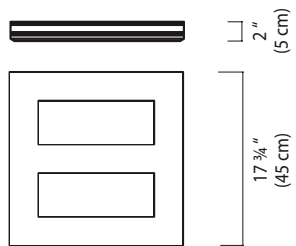

D1-2039 **ADA**
D1-2040 **ADA**



Direct and indirect light wall and pendant light. Structure in extruded anodized aluminum and chrome microperforated metal. Satined pyrex glass diffuser.

Applique et suspension à lumière directe et indirecte. Structure en extrudé d'aluminium anodisé et métal microperforé chromé. Verre de protection du siège de la lampe en pyrex satiné et parabole en aluminium.

Lámpara de pared y suspensión con luz directa e indirecta. Estructura en extruso de aluminio anodizado y metal microperforado cromado. Vidrio de protección del cuerpo lámpara en pìrex satinado y parabola en aluminio.

MODEL	CATEGORY	FINISH	MAX WATTAGE	LAMP TYPE
D1-1027	PENDANT	- ANODIZED ALUMINUM	1x100 W	R7s T3Q/3 (79 mm) 
D1-1028	PENDANT	- ANODIZED ALUMINUM	2x100 W	R7s T3Q/3 (79 mm) 
D1-1029	PENDANT	- ANODIZED ALUMINUM	3x100 W	R7s T3Q/3 (79 mm) 
D1-3027	WALL	- ANODIZED ALUMINUM	1x100 W	R7s T3Q/3 (79 mm) 
D1-3028	WALL	- ANODIZED ALUMINUM	2x100 W	R7s T3Q/3 (79 mm) 

D1-1027

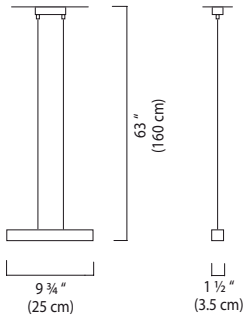

D1-1029

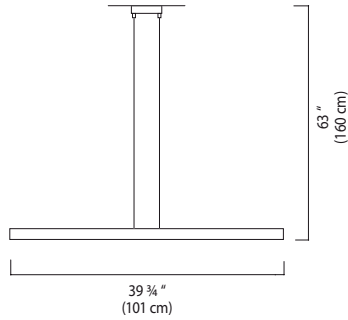

D1-1028

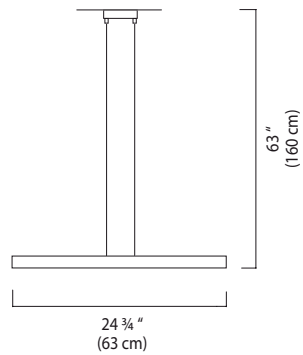

D1-3027

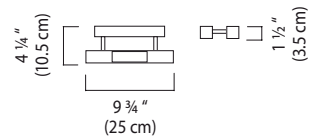

D1-3028

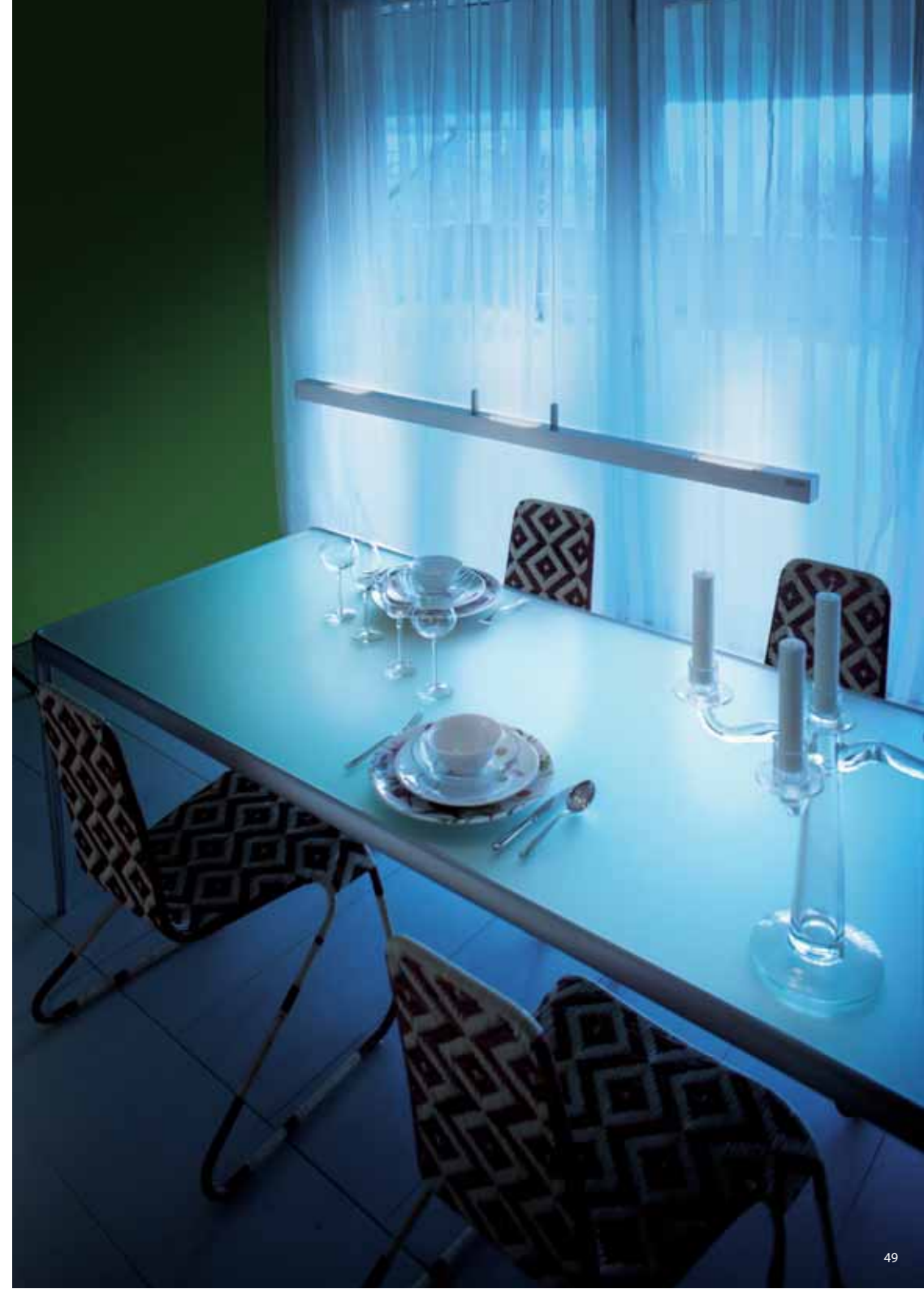
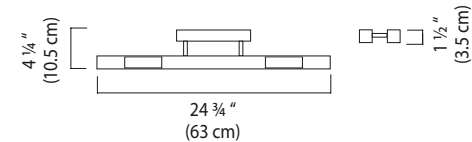

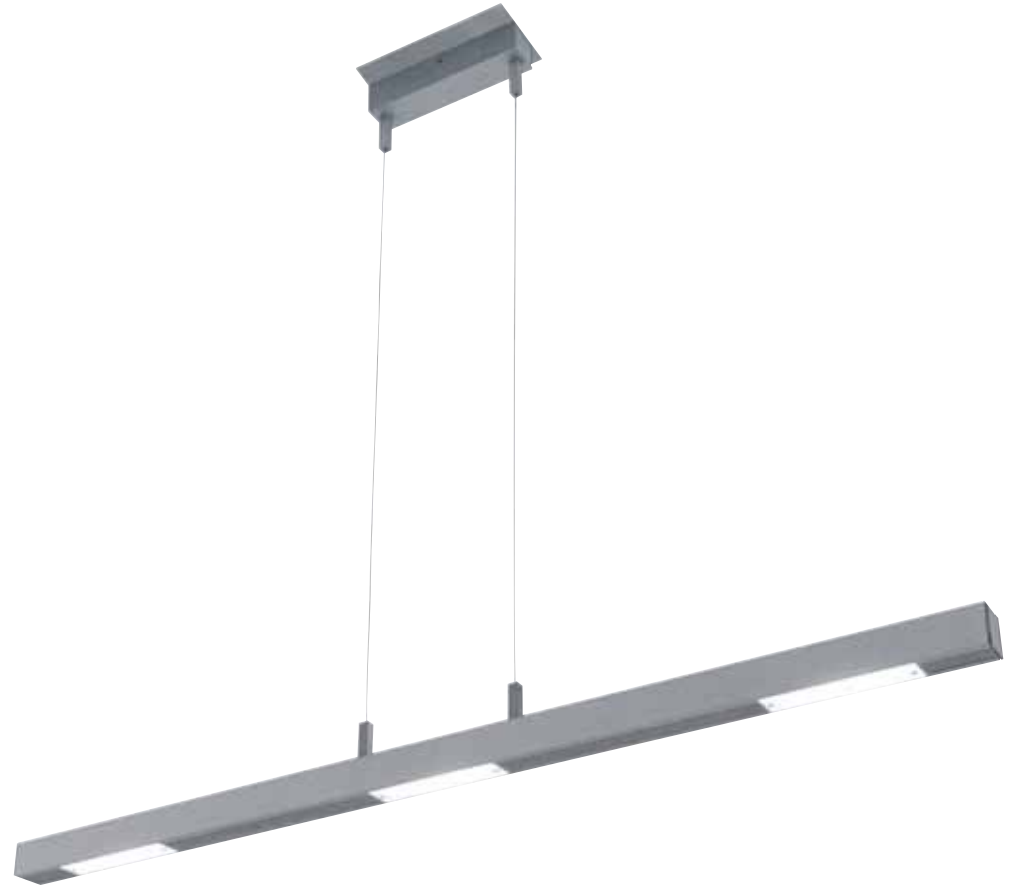

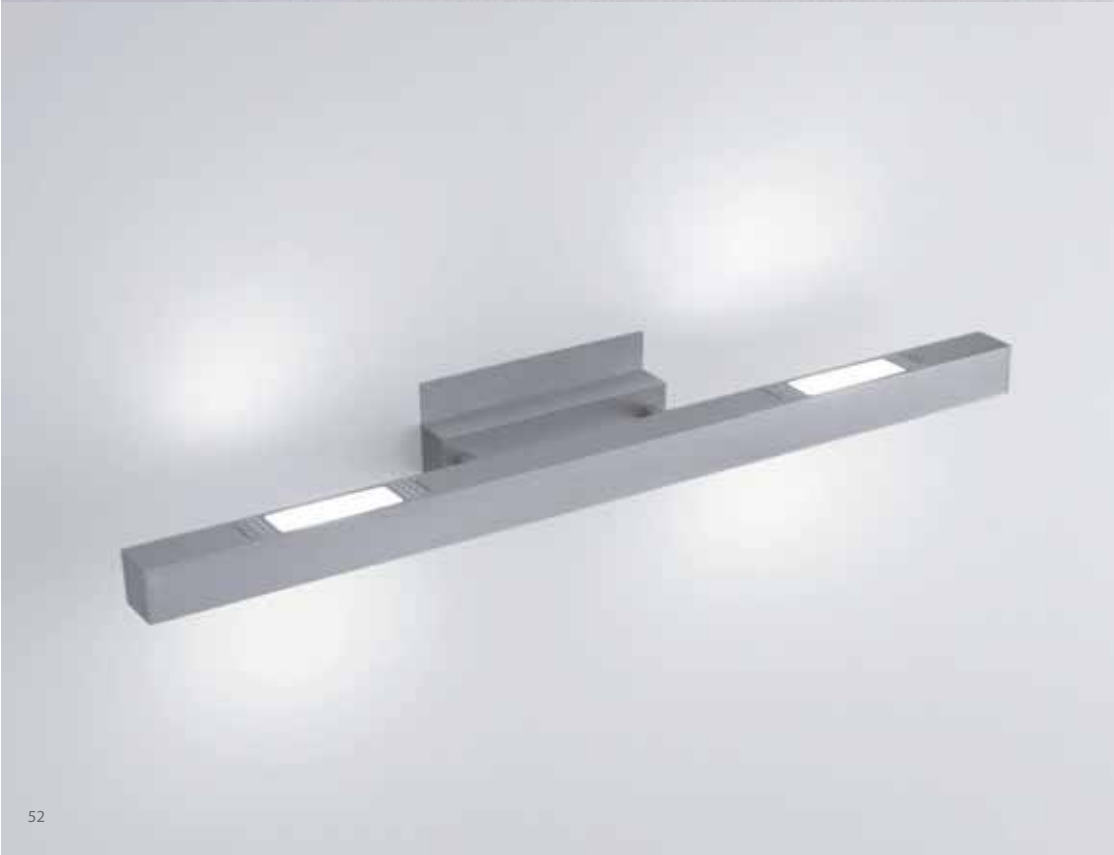
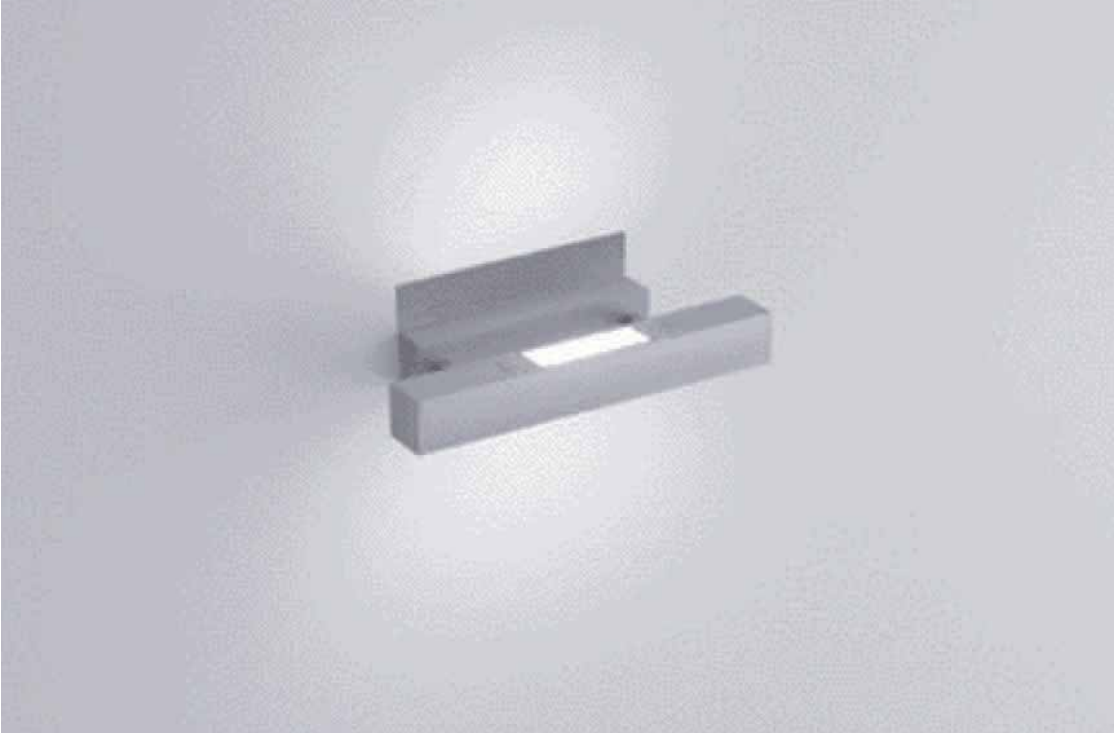





design Roberto Favaretto **Vision**

A range of diffused lighting fixtures.
Double curved rectangular glass diffuser in white satin, white clear border. Chrome finished body. For the flush mounts polished aluminum-painted metal structure, chrome finishings.

Série de lampes à lumière diffuse.
Diffuseur rectangulaire à double verre courbé doté d'une surface centrale satinée blanche et d'un cadre transparent. Structure métallique appliquée aux diffuseurs en métal chromé.

Serie de lámparas con luz difusa.
Difusor rectangular con doble vidrio curvado con superficie central satinada blanca y marco exterior transparente. Estructura metálica aplicada a los difusores cromada.

MODEL	CATEGORY	FINISH	MAX WATTAGE	LAMP TYPE
D1-1005	PENDANT	- CHROME	1x150 W	R7s T3Q (119mm) 
ADA D1-2001	CEILING / WALL	- CHROME	1x150 W	R7s T3Q (119mm) 
ADA D1-2002	CEILING / WALL	- CHROME	1x150 W	R7s T3Q (119mm) 
ADA D1-3005	WALL	- CHROME	2x100 W	E26 T10 
ADA D1-5002	CEILING / WALL	- CHROME	4x40 W	G9 T4 

D1-1005

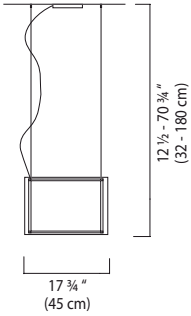

D1-3005 **ADA**

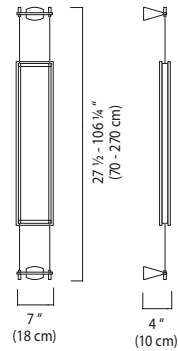

Chrome

D1-2001 **ADA**

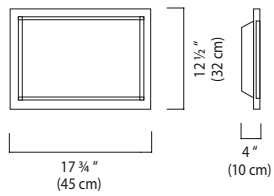

D1-2002 **ADA**

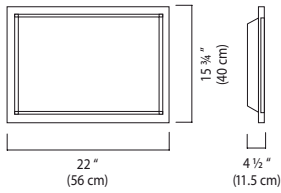

D1-5002 **ADA**

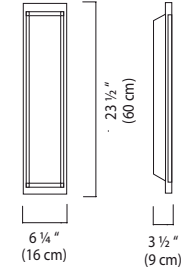













design Roberto Favaretto - Gianni Stefan **Flora**

Blown glass
diffuser in the colors:
satin opal white
satin cobalt blue
satin amber
Chrome finish.

Série de lampes à lumière directe
et diffuse. Diffuseur en verre soufflé
dans les coloris:
opale satiné
cobalt satiné
ambre satiné
Structure en métal chromé.

Serie de lámparas con luz difusa y
directa. Difusor en vidrio soplado en
los colores:
opal satinado
cobalto satinado
ambra satinado
Estructura en metal cromado.

MODEL	CATEGORY	FINISH	MAX WATTAGE	LAMP TYPE
D1-1014	PENDANT	- SATIN WHITE	1x75 W	E26 A19 
D1-1015	PENDANT	- SATIN AMBER	1x75 W	E26 A19 
D1-1016	PENDANT	- SATIN BLUE	1x75 W	E26 A19 
D1-1011	PENDANT	- SATIN WHITE	1x60 W	E12 G16 ½ 
D1-1012	PENDANT	- SATIN AMBER	1x60 W	E12 G16 ½ 
D1-1013	PENDANT	- SATIN BLUE	1x60 W	E12 G16 ½ 
D1-3017	WALL	- SATIN WHITE	1x60 W	E12 G16 ½ 
D1-3018	WALL	- SATIN AMBER	1x60 W	E12 G16 ½ 
D1-3019	WALL	- SATIN BLUE	1x60 W	E12 G16 ½ 

D1-1014
D1-1015
D1-1016

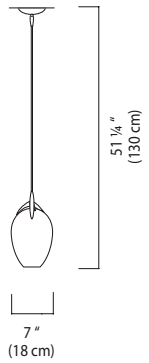

D1-1011
D1-1012
D1-1013

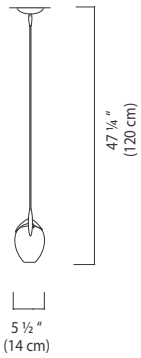

Satin white



Satin blue



Satin amber



D1-3017
D1-3018
D1-3019

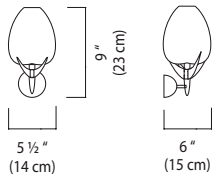

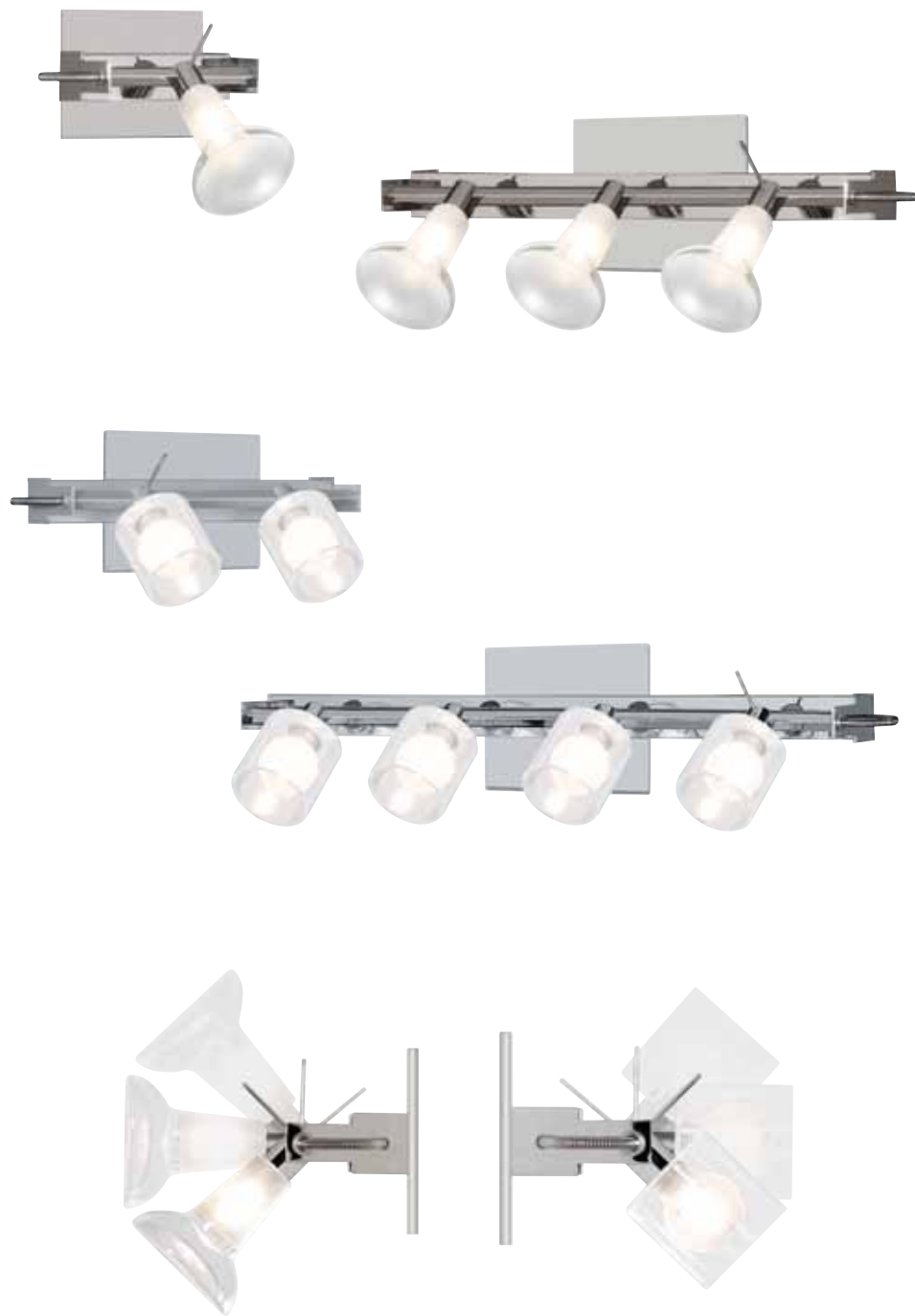

Wall lamp series.
Polished chrome or brushed nickel metal structure adjustable on the horizontal axis.
Clear blown glass diffuser, cylindrical or bell shaped.

Série comprenant appliques, éclairages plafonniers et suspensions. Structure métallique en chrome ou nickel brossé orientable sur l'axe horizontal.
Diffuseur en verre soufflé transparent, cylindrique ou en forme de cloche.

Serie de lámparas a pared, de techo y de suspensión. Estructura metálica en cromo o níquel cepillado orientable sobre el eje horizontal.
Difusor de vidrio soplado transparente, cilíndrico o en forma de campana.

MODEL	CATEGORY	FINISH	MAX WATTAGE	LAMP TYPE
D1-5007	CEILING / WALL	- CHROME	1x60 W	G9 T4
D1-5008	CEILING / WALL	- BRUSHED NICKEL	1x60 W	G9 T4
D1-5010	CEILING / WALL	- BRUSHED NICKEL	2x60 W	G9 T4
D1-5011	CEILING / WALL	- CHROME	3x60 W	G9 T4
D1-5012	CEILING / WALL	- BRUSHED NICKEL	3x60 W	G9 T4
D1-5013	CEILING / WALL	- CHROME	4x60 W	G9 T4
D1-5014	CEILING / WALL	- BRUSHED NICKEL	4x60 W	G9 T4
D1-9000	GLASS OPTION	- CYLINDRICAL		
D1-9001	GLASS OPTION	- BELL SHAPED		

Holder only - Shown with D1-9000 Glass

D1-5007
D1-5008

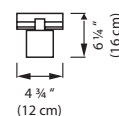

D1-5010

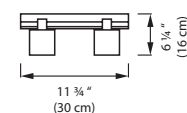

D1-5011
D1-5012

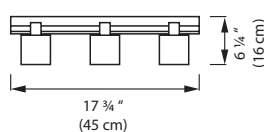

D1-5013
D1-5014

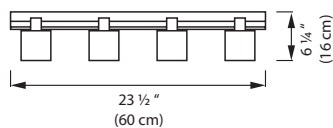

Holder only - Shown with D1-9001 Glass

D1-5007
D1-5008

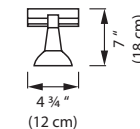

D1-5010

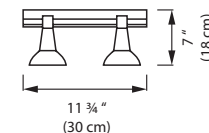

D1-5011
D1-5012

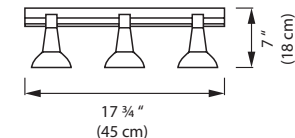

D1-5013
D1-5014

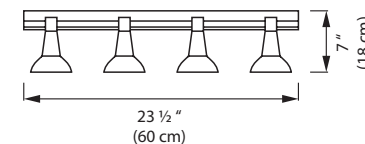

Glass must be ordered separately.

D1-9000

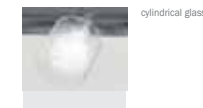

D1-9001





cylindrical glass

bell glass

Diffused light wall mount.
Brushed nickel metal frame.
Satinéd opal glass diffusers.

Applicque à lumière diffuse.
Structure en nickel brossé.
Diffuseurs en verre opalin
avec finition satinée.

Lámpara de pared con luz
difusa. Estructura en níquel cepillado.
Doble difusor en vidrio opal satinado.

	MODEL	CATEGORY	FINISH	MAX WATTAGE	LAMP TYPE
ADA	D1-3063	WALL	- BRUSHED NICKEL	1x75 W	R7s T3Q/3 (79 mm) 
ADA	D1-3064	WALL	- BRUSHED NICKEL	1x26 W	G24-q3 T4 
ADA	D1-3065	WALL	- BRUSHED NICKEL	1x36 W	2G11 T4 

D1-3063 ADA

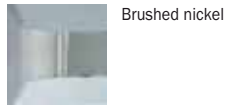
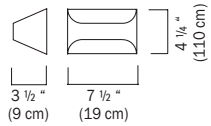

D1-3064 ADA

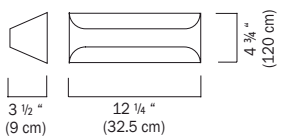

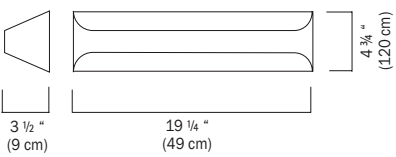

D1-3065 ADA



Indirect light fixture.
The metal reflector is brushed nickel
outside and white painted inside.

Lampe murale à lumière indirecte.
Réflecteur frontal extérieur en métal
nickel brossé et laqué blanc à l'intérieur.
Filtre rouge en option pour avoir des
effets de lumière colorée.

Lámpara de pared con luz indirecta.
Reflector frontal externo de metal níquel
cepillado y pintado de blanco en la parte
interna. Filtro opcional rojo para obtener
efectos de luz de color.

MODEL	CATEGORY	FINISH	MAX WATTAGE	LAMP TYPE
ADA D1-3066	WALL	- BRUSHED NICKEL	1x100 W	R7s T3Q/3 (79 mm) 
ADA D1-3067	WALL	- BRUSHED NICKEL	1x150 W	R7s T3Q (119 mm) 
ADA D1-3069	WALL	- BRUSHED NICKEL	1x36 W	2G11 T4 

D1-3066 ADA

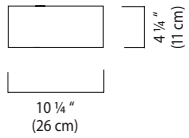

Brushed nickel

D1-3067 ADA

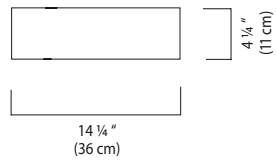

D1-3069 ADA

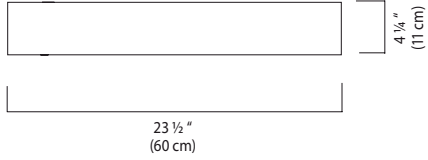

design Roberto Favaretto **Happy**

Diffuse lighting wall lamp.
Micro-perforated plate and
chromed steel lamp body.
Tempered glass diffuser.

Applique à lumière diffuse.
Corps de la lampe en tôle micro
perforée et acier chromé ou nickel
brossé.
Diffuseur en verre trempé.

Lámpara de pared con luz difusa.
Cuerpo lámpara en chapa
microperforada y acero cromado
o níquelcepillado.
Difusor en vidrio templado.

MODEL	CATEGORY	FINISH	MAX WATTAGE	LAMP TYPE
D1-3002	WALL	- CHROME	1x100 W	R7s T3Q (79mm) 

D1-3002

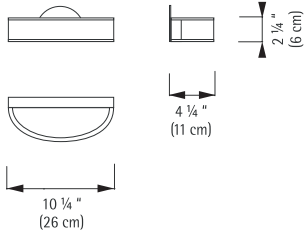

Chrome



design Roberto Favaretto **Boreale**

Diffuse light ceiling lamp.
Gray painted metal structure
and trasparent blown glass.
Round white thermoplastic
internal diffuser.

Lampe murale à lumière indirecte.
Réflecteur frontal extérieur en métal
nickel brossé et laqué blanc à l'intérieur.
Filtre rouge en option pour avoir des
effets de lumière colorée.

Lámpara de pared con luz indirecta.
Reflector frontal externo de metal níquel
cepillado y pintado de blanco en la parte
interna. Filtro opcional rojo para obtener
efectos de luz de color.

MODEL	CATEGORY	FINISH	MAX WATTAGE	LAMP TYPE
D1-2006	CEILING / WALL -	SILVER GRAY	1x28 W	2D GR10q-4 

D1-2006

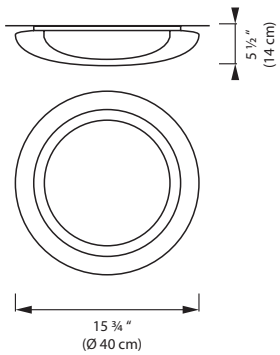

Silver gray



Wall lamp.
Gray painted
aluminum structure and
clear glass. Cylindrical and
aluminum adjustable
glass reflector and
diffuser for direct or
indirect light.

Plafonniers.
Structure
en aluminium verni et
verrière transparente.
Réflecteur et diffuseur
cylindrique orientable en
verre et aluminium pour
lumière directe et
indirecte.

Lámpara de pared.
Estructura en aluminio
lacado gris y vidrio
transparente. Reflector y
difusor cilíndrico orientable
de vidrio y aluminio para
alumbrado directo e
indirecto.



MODEL	CATEGORY	FINISH	MAX WATTAGE	LAMP TYPE
D1-3023	WALL	- SILVER GRAY	1x150W	R7s T3Q/3 (79mm)

D1-3023

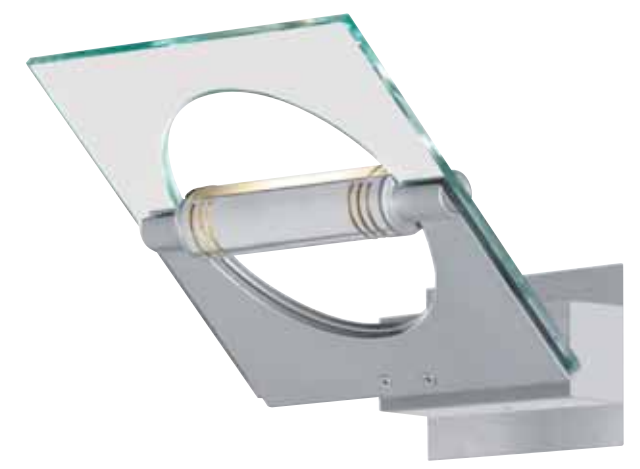
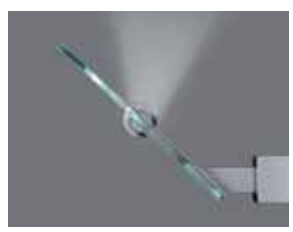
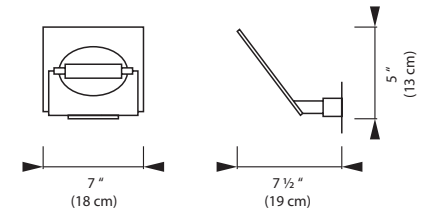

design Roberto Favaretto **Flat-Q**

Direct and diffused lighting for wall or ceiling application. The metal structure is white painted inside. The PMMA acrylic diffuser is opal satin. The frames are available in white, gray and brushed nickel. The polished chrome option is only available for the frames sizing 150x150, 300x300 and 450x450.

Série de lampes murales et de plafonniers à lumière directe et diffuse, structure interne en métal laqué blanc, structure interne en métal laqué blanc, diffuseur en PMMA opalin avec finition satinée. Cadre disponibles en: blanc et gris laqué et nickel brossé. Cadre pour le dimensions 150x150, 300x300 et 450x450 disponible aussi chrome brillant.

Serie de luminarias de pared y de techo con luz directa y difusa, estructura interna de metal barnizado blanco, difusor de PMMA opalino. Marcos disponibles con diferentes acabados: blanco o gris barnizado, níquel cepillado. Marco 150x150, 300x300 y 450x450 es disponible en cromo brillo.

MODEL	CATEGORY	FINISH	MAX WATTAGE	LAMP TYPE
ADA D1-2045	CEILING / WALL	- WHITE	1x13 W	GX23-2 T4 MAGNETIC BALLAST
ADA D1-2046	CEILING / WALL	- BRUSHED NICKEL	1x13 W	GX23-2 T4 MAGNETIC BALLAST
ADA D1-2047	CEILING / WALL	- CHROME	1x13 W	GX23-2 T4 MAGNETIC BALLAST
ADA D1-2048	CEILING / WALL	- WHITE	2x18 W	2G11 T4
ADA D1-2049	CEILING / WALL	- BRUSHED NICKEL	2x18 W	2G11 T4
ADA D1-2050	CEILING / WALL	- CHROME	2x18 W	2G11 T4
ADA D1-2051	CEILING / WALL	- WHITE	3x36 W	2G11 T4
ADA D1-2052	CEILING / WALL	- BRUSHED NICKEL	3x36 W	2G11 T4
ADA D1-2053	CEILING / WALL	- CHROME	3x36 W	2G11 T4
ADA D1-2054	CEILING / WALL	- WHITE	3x55 W	2G11 T4
ADA D1-2055	CEILING / WALL	- BRUSHED NICKEL	3x55 W	2G11 T4

D1-2045 ADA
 D1-2046 ADA
 D1-2047 ADA

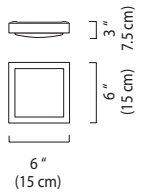

D1-2048 ADA
 D1-2049 ADA
 D1-2050 ADA

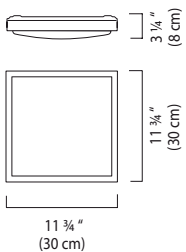

D1-2051 ADA
 D1-2052 ADA
 D1-2053 ADA

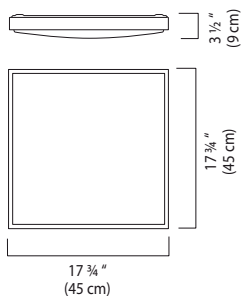

D1-2054 ADA
 D1-2055 ADA

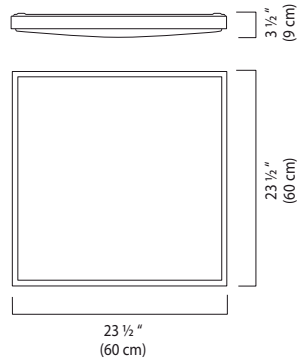







Direct and diffused light wall and ceiling lamps. The metal structure is white painted inside. The PMMA acrylic diffuser is opal satin. The frames are available in white, gray, brushed nickel and polished chrome.

Série de lampes murales et de plafonniers à lumière directe et diffuse, structure interne en métal laqué blanc, diffuseur en PMMA opalin avec finition satinée. Cadre disponibles en quatre finitions: blanc et gris laqué, chrome brillant et nickel brossé.

Serie de luminarias de pared y de techo con luz directa y difusa, estructura interna de metal barnizado blanco, difusor de PMMA opalino. Marcos disponibles con cuatro diferentes acabados: blanco o gris barnizado, cromo brillo y níquel cepillado.



	MODEL	CATEGORY	FINISH	MAX WATTAGE	LAMP TYPE
ADA	D1-2060	WALL	- WHITE	2x24 W	G5 T5 
ADA	D1-2061	WALL	- BRUSHED NICKEL	2x24 W	G5 T5 
ADA	D1-2062	WALL	- CHROME	2x24 W	G5 T5 
ADA	D1-2063	CEILING / WALL	- WHITE	2x39 W	G5 T5 
ADA	D1-2064	CEILING / WALL	- BRUSHED NICKEL	2x39 W	G5 T5 
ADA	D1-2065	CEILING / WALL	- CHROME	2x39 W	G5 T5 



D1-2060 ADA
D1-2061 ADA
D1-2062 ADA

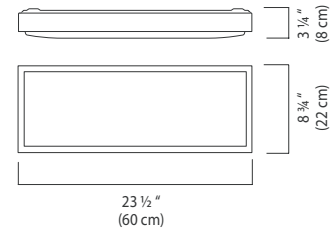

D1-2063 ADA
D1-2064 ADA
D1-2065 ADA

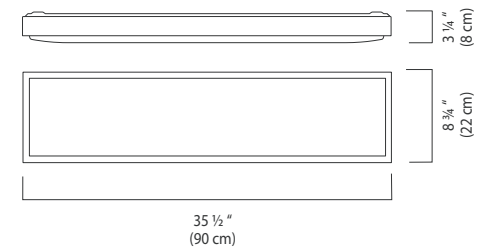



design Roberto Favaretto

Ai-Pi

Stainless steel

Diffuse light ceiling of wall lamp. New version stainless AISI 304. Master point glass. Bayonet ring fastened. Sealed with silicone rubber. IP 54.

Plafonnier ou applique à lumière diffuse. Structure métallique vernie en deux couleurs ou galvanisé. Verre traité à l'acide. Fixation de la bague à baïonnette. Les joints d'étanchéité sont en silicone. IP 54. New version inox steel AISI 304.

Plafón de techo y de pared. Estructura metálica en acero inox AISI 304. Vidrio masterpoint. Fijaje del anillo a bayoneta. Juntas de goma silicónica para una perfecta estanqueidad. IP 54.



Wet location : Exterior / Interior

	MODEL	CATEGORY	FINISH	MAX WATTAGE	LAMP TYPE
ADA	D1-2022	CEILING / WALL	- STAINLESS	1x60 W	E26 A19
	D1-2023	CEILING / WALL	- STAINLESS	2x60 W	E26 A19
ADA	D1-3034	CEILING / WALL	- STAINLESS	1x40 W	G9 T4

D1-3034 ADA

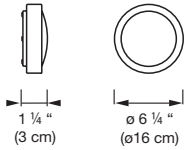

Stainless steel

D1-2022 ADA

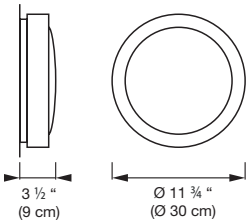

D1-2023

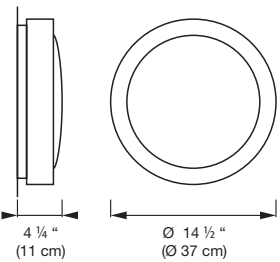

design Roberto Favaretto

Ai-Pi

Diffuse light ceiling and wall lamp. Two colors painted or galvanized metal structure. Satined glass. Bayonet ring fastened. Sealed with silicone rubber. IP 54.

Plafonnier ou applique à lumière diffuse. Structure métallique vernie en deux couleurs ou galvanisée. Verre traité à l'acide. Fixation de la bague à baïonnette. Les joints d'étanchéité sont en silicone. IP 54.

Plafón de techo y de pared. Estructura metálica lacada en dos colores o galvanizada. Vidrio satinado. Fijaje del anillo a bayoneta. Juntas de goma silicónica para una perfecta estanqueidad. IP 54.



Wet location : Interior only

	MODEL	CATEGORY	FINISH	MAX WATTAGE	LAMP TYPE
ADA	D1-2014	WALL / CEILING	- BRUSHED NICKEL	1x60 W	E26 A19
	D1-2015	WALL / CEILING	- BRUSHED NICKEL	2x60 W	E26 A19
ADA	D1-2016	WALL / CEILING	- GRAY PAINTED	1x60 W	E26 A19
	D1-2017	WALL / CEILING	- GRAY PAINTED	2x60 W	E26 A19
ADA	D1-2018	WALL / CEILING	- WHITE	1x60 W	E26 A19
	D1-2019	WALL / CEILING	- WHITE	2x60 W	E26 A19
ADA	D1-2020	WALL / CEILING	- CHROME	1x60 W	E26 A19
	D1-2021	WALL / CEILING	- CHROME	2x60 W	E26 A19
	D1-2056	WALL / CEILING	- WHITE	3x60 W	E26 A19
	D1-2057	WALL / CEILING	- GRAY PAINTED	3x60 W	E26 A19
	D1-2058	WALL / CEILING	- BRUSHED NICKEL	3x60 W	E26 A19
ADA	D1-3030	WALL / CEILING	- BRUSHED NICKEL	1x40 W	G9 T4
ADA	D1-3031	WALL / CEILING	- GRAY PAINTED	1x40 W	G9 T4
ADA	D1-3032	WALL / CEILING	- WHITE	1x40 W	G9 T4
ADA	D1-3033	WALL / CEILING	- CHROME	1x40 W	G9 T4

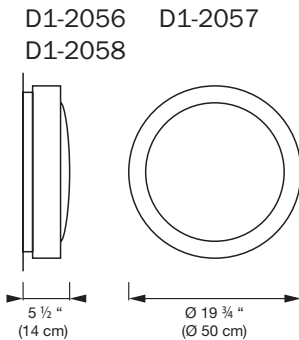
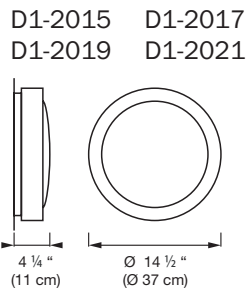
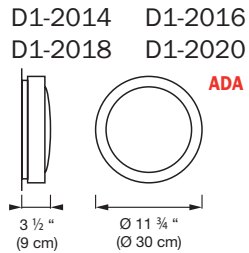
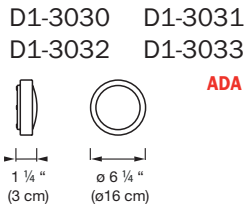



Wall and ceiling fixture made of polymethylmethacrylate (PMMA), ideal for outdoor use. Choice of two diameters : 300mm and 425 mm. Prismatic and opal diffuser. Aluminium reflector.

Applique et plafonnier en polymethylmethacrylate (PMMA), indiquée soit pour l'extérieur soit pour l'intérieur. Diffuseur transparent prismatique ou blanc opale. Réflecteur en aluminium.

Aplique y plafón en PMMA, ideal para ambientes exteriores. Disponibles en dos tamaños 300 mm and 425 mm. Difusor prismático o opal. Reflector en aluminio.



Wet location : Exterior / Interior



	MODEL	CATEGORY	FINISH	MAX WATTAGE	LAMP TYPE
ADA	D1-2066	CEILING / WALL	- BLACK	2x13 W	2G11 T4
ADA	D1-2067	CEILING / WALL	- WHITE	2x13 W	2G11 T4
ADA	D1-2070	CEILING / WALL	- BLACK	2x13 W	2G11 T4
ADA	D1-2071	CEILING / WALL	- WHITE	2x13 W	2G11 T4

D1-2066 ADA
D1-2067 ADA

D1-2070 ADA
D1-2071 ADA

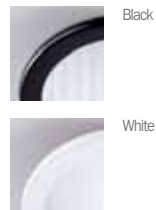
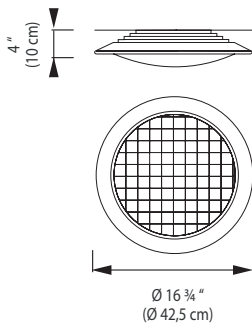
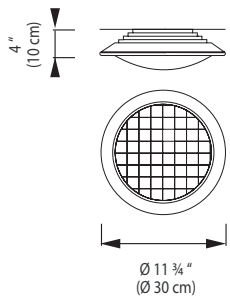

Wall and ceiling fixture made of polymethylmethacrylate (PMMA), ideal for outdoor use. Choice of two diameters : 300mm and 425 mm. Prismatic and opal diffuser. Aluminium reflector.

Applique et plafonnier en polymethylmethacrylate (PMMA), indiquée soit pour l'extérieur soit pour l'intérieur. Diffuseur transparent prismatique ou blanc opale. Réflecteur en aluminium.

Aplique y plafón en PMMA, ideal para ambientes exteriores. Disponibles en dos tamaños 300 mm and 425 mm. Difusor prismático o opal. Reflector en aluminio.



Wet location : Exterior / Interior



	MODEL	CATEGORY	FINISH	MAX WATTAGE	LAMP TYPE
ADA	D1-2068	CEILING / WALL	- BLACK	2x13 W	2G11 T4
ADA	D1-2069	CEILING / WALL	- WHITE	2x13 W	2G11 T4
ADA	D1-2072	CEILING / WALL	- BLACK	2x13 W	2G11 T4
ADA	D1-2073	CEILING / WALL	- WHITE	2x13 W	2G11 T4

D1-2068 ADA
D1-2069 ADA

D1-2072 ADA
D1-2073 ADA

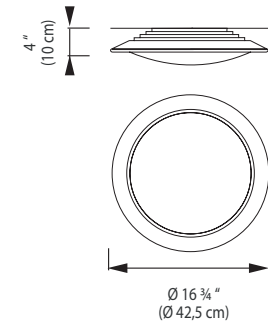
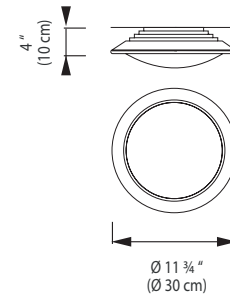



Reflected light wall lamp series. Stainless steel reflector. Painted metal holder.

Applique à lumière réfléchie. Structure en métal verni. Partie frontale de acier.

Aplicae con luz refleja. Parte frontal de acero satinado. Estructura de metal lacado.

	MODEL	CATEGORY	FINISH	MAX WATTAGE	LAMP TYPE
ADA	D2-3037	WALL	- STAINLESS STEEL	1x24W	2G11 T4

D2-3037 ADA

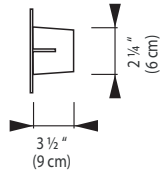
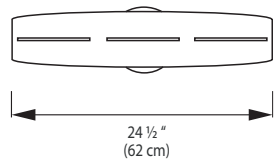

Stainless steel

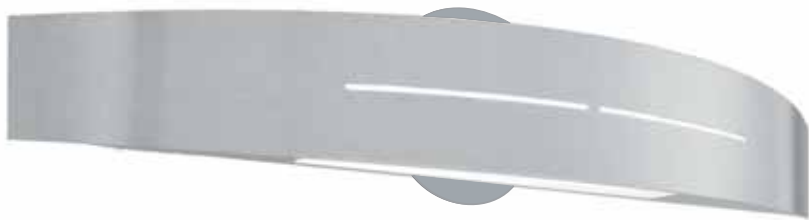

Diffused light wall lamp.
Painted metal holder.
Satin colored glass
diffuser available in the
colors: white and amber.

Applique à lumière diffuse.
 Structure en métal verni.
 Diffuseur en verre coloré
 et satiné. Verre disponible
 dans les coloris: blanc et
 ambre.

Aplicue con luz difundida.
 Estructura en metal
 lacado. Vidrio colorado y
 satinado, disponible en
 los colores: blanco y
 ámbar.

MODEL	CATEGORY	FINISH	MAX WATTAGE	LAMP TYPE
ADA D2-3038	WALL	- WHITE	1x100W	R7s T3Q/3 (79mm)
ADA D2-3039	WALL	- AMBER	1x100W	R7s T3Q/3 (79mm)
ADA D2-3040	WALL	- WHITE	1x150W	R7s T3Q (119 mm)
ADA D2-3041	WALL	- AMBER	1x150W	R7s T3Q (119 mm)
ADA D2-3044	WALL	- WHITE	1x36W	2G11 T4
ADA D2-3045	WALL	- AMBER	1x36W	2G11 T4

D2-3038 ADA
 D2-3039 ADA

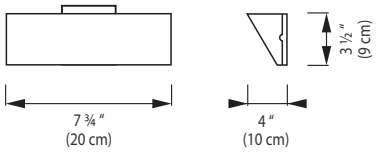

Amber



White

D2-3040 ADA
 D2-3041 ADA

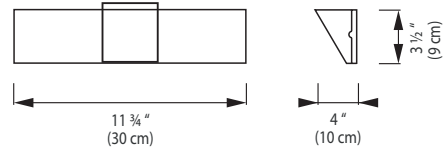

D2-3044 ADA
 D2-3045 ADA

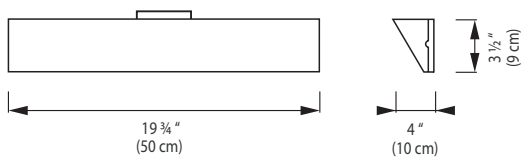

design Roberto Favaretto **Duplex**

Diffused light lamps.
Painted metal structure.
White diffusers.

Série de lampes à lumière diffuse. Structure en métal verni. Verres disponible dans le couleurs blanc.

Serie de lámparas con luz difusa. Estructura en metal lacado. Vidrio disponible en los colores blanco.

MODEL	CATEGORY	FINISH	MAX WATTAGE	LAMP TYPE
D2-1025	PENDANT	- WHITE	2x39W	G5 T5
ADA D2-3048	WALL	- WHITE	1x150W	R7s T3Q (119 mm)
ADA D2-3049	WALL	- WHITE	1x24W	G5 T5

D2-1025

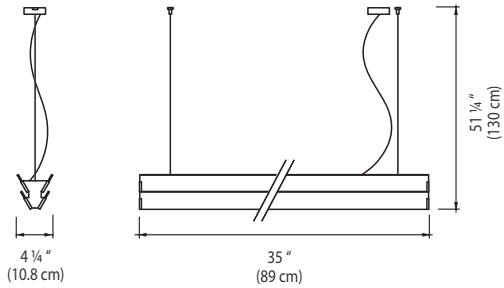

White

D2-3049 **ADA**

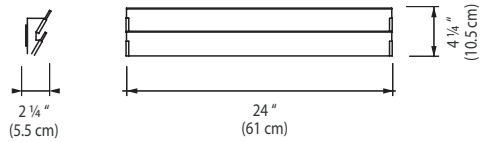

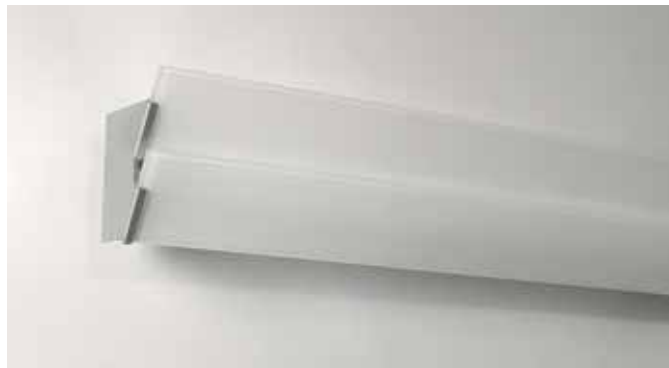
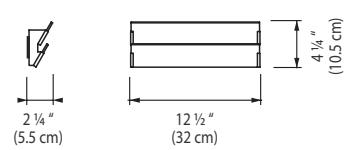

D2-3048 **ADA**



Diffused light lamp series in the versions of wall and pendant. Painted metal holder. Satined blown glass diffuser available in white.

Série comprenant appliques, éclairages et suspensions, lumière diffuse. Structure en métal verni. Verre soufflé satiné blanc.

Serie de apliques y colgantes con luz difundida. Estructura en metal lacado. Vidrio soplado satinado blanco.

MODEL	CATEGORY	FINISH	MAX WATTAGE	LAMP TYPE
D2-1024	PENDANT	- WHITE	1x24W	G5 T5 
ADA D2-3036	WALL	- WHITE	1x24W	G5 T5 

D2-3036 **ADA**

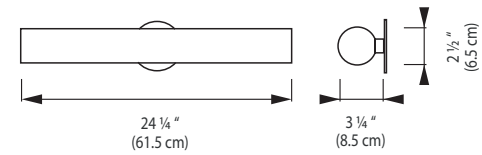

D2-1024

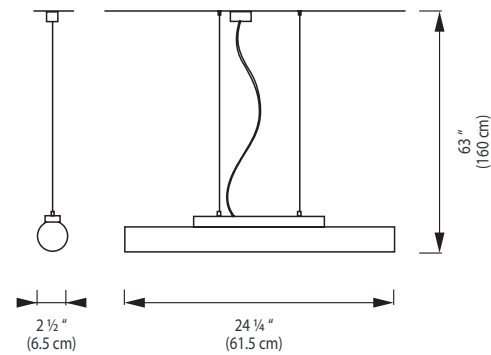

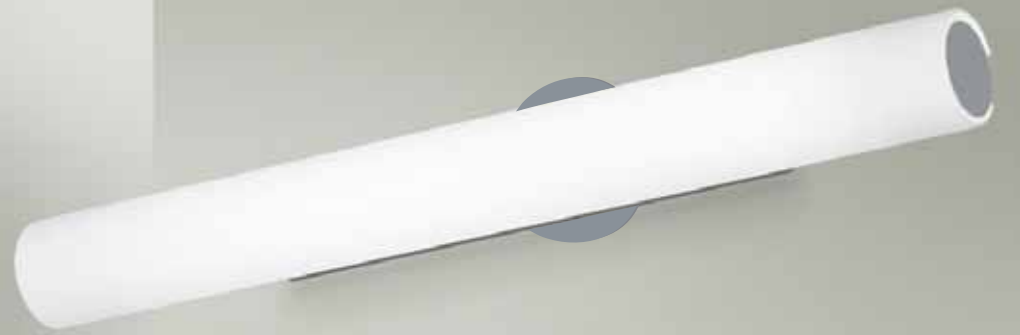

Diffused light wall lamp
 Gray painted
 metal holder with
 chrome details.
 White satin glass diffuser.

Structure en
 métal verni avec des
 particuliers chromés.
 Diffuseur en verre satiné
 opale.

Estructura en
 metal lacado con detalles
 cromados. Difusor en
 vidrio satinado opal.

MODEL	CATEGORY	FINISH	MAX WATTAGE	LAMP TYPE
D2-3050	WALL	- WHITE	1x100W	E26 A19 

D2-3050

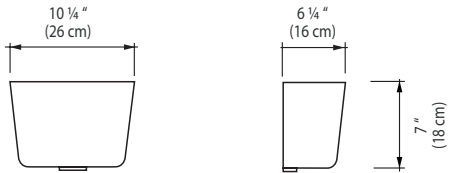

Diffused and reflected light wall lamp. Painted metal holder. White satined glass diffuser.

Applique à lumière diffuse et réfléchi. Structure en métal verni. Verre coloré blanc avec des finissages blancs satinés. Disponible dans la version halogène et/ou fluorescente

Aplicae con luz difundida y refleja. Estructura de metal lacado. Vidrio de color blanco con acabados blancos satinados. Disponible en la versión alógena y/o fluorescente

MODEL	CATEGORY	FINISH	MAX WATTAGE	LAMP TYPE
D2-3046	WALL	- WHITE	1x100 W	R7s T3Q/3 (79mm)

D2-3046

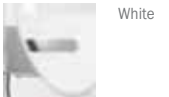
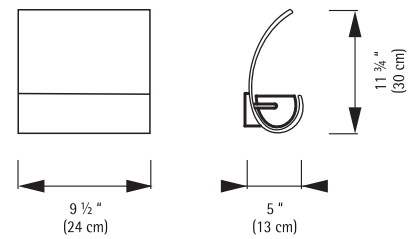

Diffused light pendant and ceiling lamps.
Painted metal holder with chromed details.
White satin blown glass diffuser. Electronic ballast.

Série de lampes à lumière diffuse. Structure en métal verni avec des particuliers chromés.
Verre soufflé satiné blanc. Ballast électronique dans la version fluorescente.

Serie de lámparas con luz difusa. Estructura en metal lacado con detalles cromados. Vidrio soplado satinado blanco. Ballast electrónico en la versión con fluorescencia.

MODEL	CATEGORY	FINISH	MAX WATTAGE	LAMP TYPE
D2-1026	PENDANT	- WHITE	1x18W	2G11 T4
D2-1027	PENDANT	- WHITE	1x24W	2G11 T4
D2-1028	PENDANT	- WHITE	1x36W	2G11 T4
D2-2045	CEILING	- WHITE	1x18W	2G11 T4
D2-2046	CEILING	- WHITE	1x24W	2G11 T4
D2-2047	CEILING	- WHITE	1x36W	2G11 T4

D2-2045

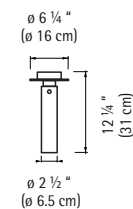

D2-2046

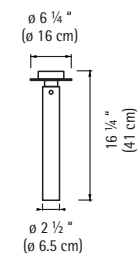

D2-2047

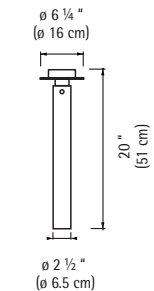

White

D2-1026

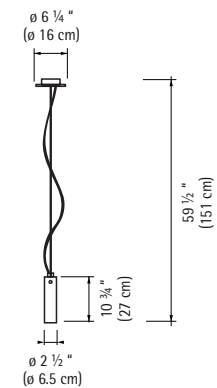

D2-1027

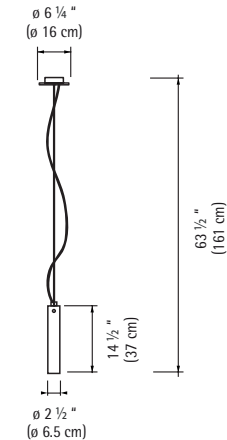

D2-1028

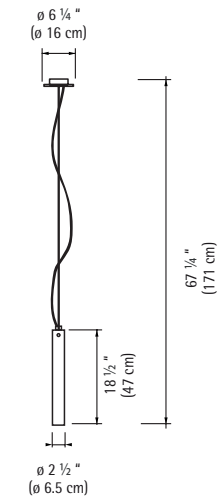



Wall lamps. Gray painted metal holder.
Screen-printed thermo glass diffuser.

Série de lampes à lumière diffuse. Structure en métal verni. Diffuseur en verre courbé sérigraphié satiné.

Serie de lâmparas con luz difusa. Estructura en metal lacado. Vidrio curvado serigrafiado satinado.

	MODEL	CATEGORY	FINISH	MAX WATTAGE	LAMP TYPE
ADA	D2-3051	WALL	- SILVER GRAY	1x36W	2G11 T4
ADA	D2-3052	WALL	- SILVER GRAY	2x18W	2G11 T4

D2-3051 ADA

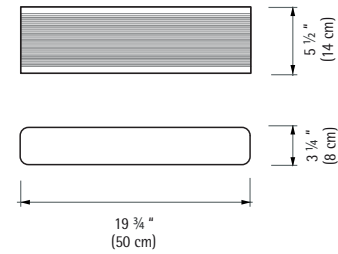

D2-3052 ADA

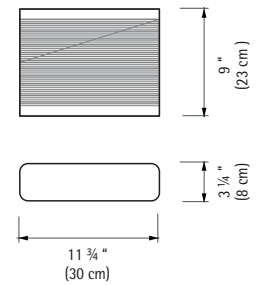

A range of wall and pendant lamps.
Diffuser in blown satin glass. Chrome-plated and painted metal structure. Interchangeable colored filters in white, yellow and blue.

Série d'appliques et suspensions.
Diffuseur en verre soufflé satiné. Structure en métal chromé et verni. Filtres teintés interchangeables disponibles en blanc, jaune et bleu.

Serie de lámpara de pared y de suspensión.
Difusor en vidrio soplado satinado. Estructura en metal cromado y barnizado. Filtros colorados intercambiables en los colores: blanco, amarillo y azul.

MODEL	CATEGORY	FINISH	MAX WATTAGE	LAMP TYPE
D2-1001	PENDANT	- CHROME	1x100W	E26 A19 
D2-3000	WALL	- CHROME	1x60W	E26 A19 
D2-4000	FLOOR	- CHROME	1x250W	E26 BT15 



Chrome

D2-3000

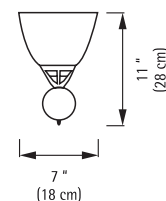

D2-1001

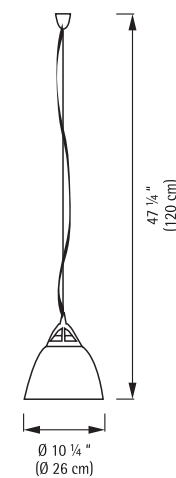

D2-4000

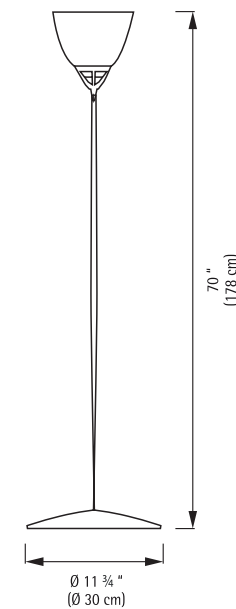



A range of wall and pendant lamps. Diffuser in blown satin glass. Painted metal structure.

Série d'appliques et suspensions. Diffuseur en verre soufflé satiné. Structure en métal verni.

Serie de lámparas de pared y de suspensión. Difusor en vidrio soplado satinado. Base en metal barnizado.



TYPE	CATEGORY	FINISH	MAX WATTAGE	LAMP TYPE
D2-1011	PENDANT	- WHITE	1x60 W	E12 G16 ½
D2-1012	PENDANT	- AMBER	1x60 W	E12 G16 ½
D2-1013	PENDANT	- BLUE	1x60 W	E12 G16 ½
D2-3013	WALL	- WHITE	1x60 W	E26 A19
D2-3014	WALL	- AMBER	1x60 W	E26 A19
D2-3015	WALL	- BLUE	1x60 W	E26 A19



D2-3013
D2-3014
D2-3015

D2-1011
D2-1012
D2-1013

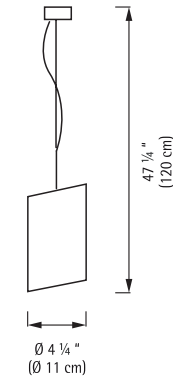
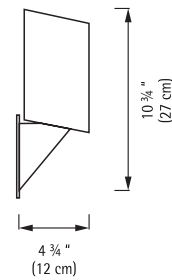

design Roberto Favaretto **Ersilia**

Wall lamps.
Painted and
chrome metal
structure. Satin finished
glass diffuser.

Appliques.
Structure en métal laqué
et chromé, diffuseur en
verre satiné.

Lámpara de
pared.
Estructura en
metal lacado y cromado.
Difusor en vidrio satinado.

MODEL	CATEGORY	FINISH	MAX WATTAGE	LAMP TYPE
D2-3005	WALL	CHROME	1x150 W	R7s T3Q/3 (79mm)

D2-3005

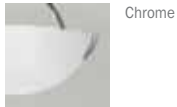
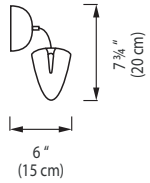
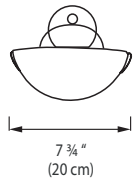



design Poom Lab **Prima**

A range of wall and ceiling lamps with diffused and direct light. Gray painted metal holder, satin-finished glass in the colors: amberand opale white.

Applique à lumière directe et diffuse. Support en métal. Diffuseur en verre satiné dans le coloris: opale et ambré.

Lámpara de pared con luz difundida y directa. Estructura en metal lacado gris. Difusor en vidrio satinado en los colores: opal y ámbar.

MODEL	CATEGORY	FINISH	MAX WATTAGE	LAMP TYPE
D2-3008	WALL	- AMBER	1x100 W	E26 A19 
D2-3010	WALL	- WHITE	1x100 W	E26 A19 

D2-3008
D2-3010

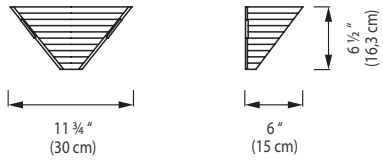
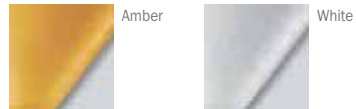

design Roberto Favaretto **Rock**

Pendant lamps.
Chrome plated
metal structure. Satin
glass diffusers.

Lampadaires. Structure en
métal chromé. Diffuseurs
en verre satiné.

Suspensión.
Estructura en metal
cromado.

MODEL	CATEGORY	FINISH	MAX WATTAGE	LAMP TYPE
D2-1003	PENDANT	- CHROME	1x100 W	R7s T3Q (119 mm) 

D2-1003

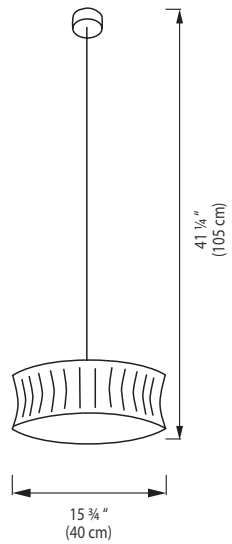

design Poom Lab **Fluonight**

Adjustable reflected light wall lamp. Metal front reflector available in the gray painted or glossy chrome versions.

The reflector is adjustable and light is emitted through the front boring, as well as from the top and bottom of the fixture.

The fixture base is in gray painted scored metal. The diffuser supports are in chrome.

Applique à lumière réfléchie et orientable. Spot frontal en métal disponible dans la version grise ou chromée brillante.

Le spot est orientable et permet l'émission de lumière non seulement à travers l'ouverture frontale mais également sur la partie supérieure et inférieure.

La base de l'applique est en métal rayé verni gris. Les supports du diffuseur sont en métal chromé.

Plafón de pared con luz refleja y orientable. Reflector frontal de metal disponible en versión barnizada gris o cromada brilla.

El reflector es orientable y permite la emisión de luz frontal por medio de unos pinchazos, y la emisión de luz en la parte superior e inferior del aparato. La base del aparato es de metal rayado barnizado gris.

Los soportes del vidrio son de metal cromado.

	MODEL	CATEGORY	FINISH	MAX WATTAGE	LAMP TYPE
ADA	D2-3020	WALL	- CHROME	1x100 W	R7s T3Q/3 (79mm)
ADA	D2-3021	WALL	- CHROME	1x150 W	R7s T3Q (119mm)
ADA	D2-3022	WALL	- CHROME	1x36 W	2G11 T4

D2-3020 ADA

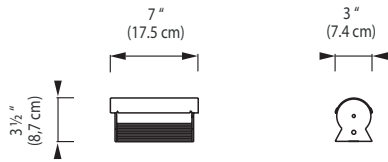

Chrome

D2-3021 ADA

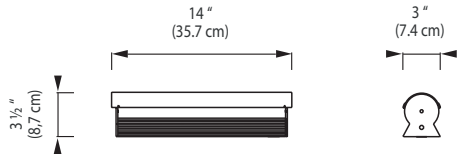

D2-3022 ADA

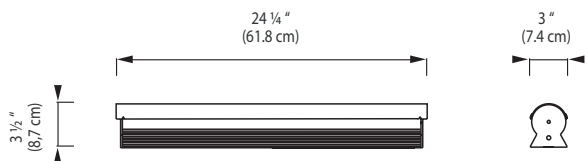





Reflected and indirect wall or ceiling lamp. The reflector allows emission of frontal light through the micro-borings as well as emission of light at the top and bottom of the fixture. Front metal reflector available in brushed chrome. Hot is available in three different dimensions and versions with fluorescent or halogen luminous sources.

Applique ou plafonnier à lumière réfléchié et indirecte. Le réflecteur permet l'émission de lumière frontale, à travers des micro-ouvertures, ainsi que l'émission de lumière sur la partie supérieure et inférieure de l'appique. Réflecteur frontal en métal disponible dans les versions vernies ou en chrome brossé. Hot est disponible en trois dimensions et dans les versions avec sources lumineuses halogènes ou fluorescentes.

Plafón de techo o de pared con luz refleja y indirecta. El reflector permite la emisión de luz frontal por medio de micro-pinchazos, y la emisión de luz en la parte superior e inferior del aparato. Reflector frontal de metal disponible en version barnizada o cromo cepillado. Hot está disponible en tres dimensiones y en versiones con fuentes luminosas alógenas o fluorescentes.

	MODEL	CATEGORY	FINISH	MAX WATTAGE	LAMP TYPE
ADA	D2-3023	WALL	- BRUSHED CHROME	1x100 W	R7s T3Q/3 (79mm) 
ADA	D2-3024	WALL	- BRUSHED CHROME	1x150 W	R7s T3Q (119mm) 
ADA	D2-3025	WALL	- BRUSHED CHROME	1x24 W	2G11 T4 

D2-3023 ADA

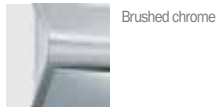
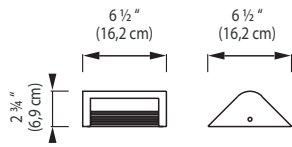

D2-3024 ADA

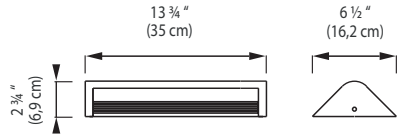

D2-3025 ADA

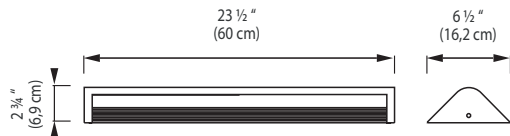

Diffuse and indirect light wall lamp.
Gray painted metal structure and glossy chrome front screen.
Gea is available in two sizes with sanded glass in two sizes with halogen light source.

Applique à lumière diffuse et indirecte.
Structure en métal verni gris et écran frontal en chrome brillant.
Gea est disponible dans la version avec verre sablé ou sans verre, en deux dimensions avec sources lumineuses halogènes.

Plafón de pared con luz difundida y indirecta.
Estructura de metal barnizado gris y protección frontal cromada. Gea está disponible en versión con vidrio arenado o sin vidrio. Está disponible en dos dimensiones con fuentes luminosas alógenas.

MODEL	CATEGORY	FINISH	MAX WATTAGE	LAMP TYPE
D2-3026	WALL	-	1x100 W	R7s T3Q/3 (79mm)
D2-3027	WALL	-	1x150 W	R7s T3Q (119mm)

D2-3026

D2-3027

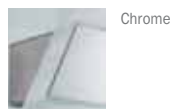
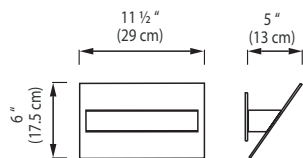
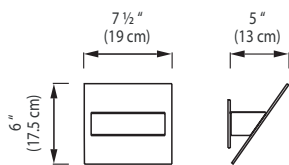

Diffuse light wall lamp consisting of a gray painted scored metal support and satin glass diffuser. It can be used singularly or in modular compositions. Dome is available in four sizes and in fluorescent or incandescence light source versions.

Applique à lumière diffuse, réalisé avec un support en métal rayé verni gris et diffuseurs en verre satiné. On peut l'utiliser seul ou dans des compositions modulaires. Domino est disponible en quatre dimensions et dans les versions avec sources lumineuses fluorescentes ou à incandescence.

Plafón de pared con luz difundida realizada con un soporte de metal rayado barnizado gris y difusores de vidrio satinado. Puede utilizarse singularmente o en composiciones modulares. Domino está disponible en cuatro dimensiones y en versiones con fuentes luminosas fluorescentes o incandescentes.

MODEL	CATEGORY	FINISH	MAX WATTAGE	LAMP TYPE
ADA D2-3030	WALL	- SILVER GRAY	1x60 W	G9 T4 
ADA D2-3031	WALL	- SILVER GRAY	2x60 W	G9 T4 
ADA D2-3032	WALL	- SILVER GRAY	3x60 W	G9 T4 
ADA D2-3033	WALL	- SILVER GRAY	1x100 W	E26 A19 

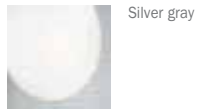

D2-3030 ADA

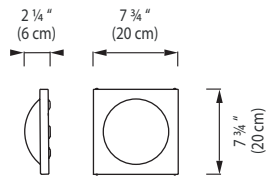

D2-3031 ADA

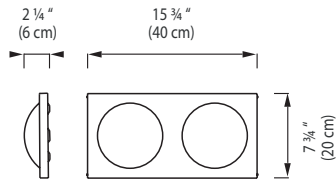

D2-3033 ADA

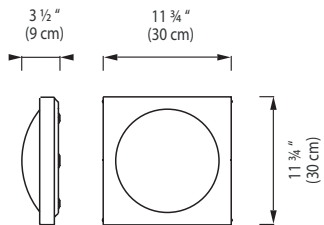

D2-3032 ADA

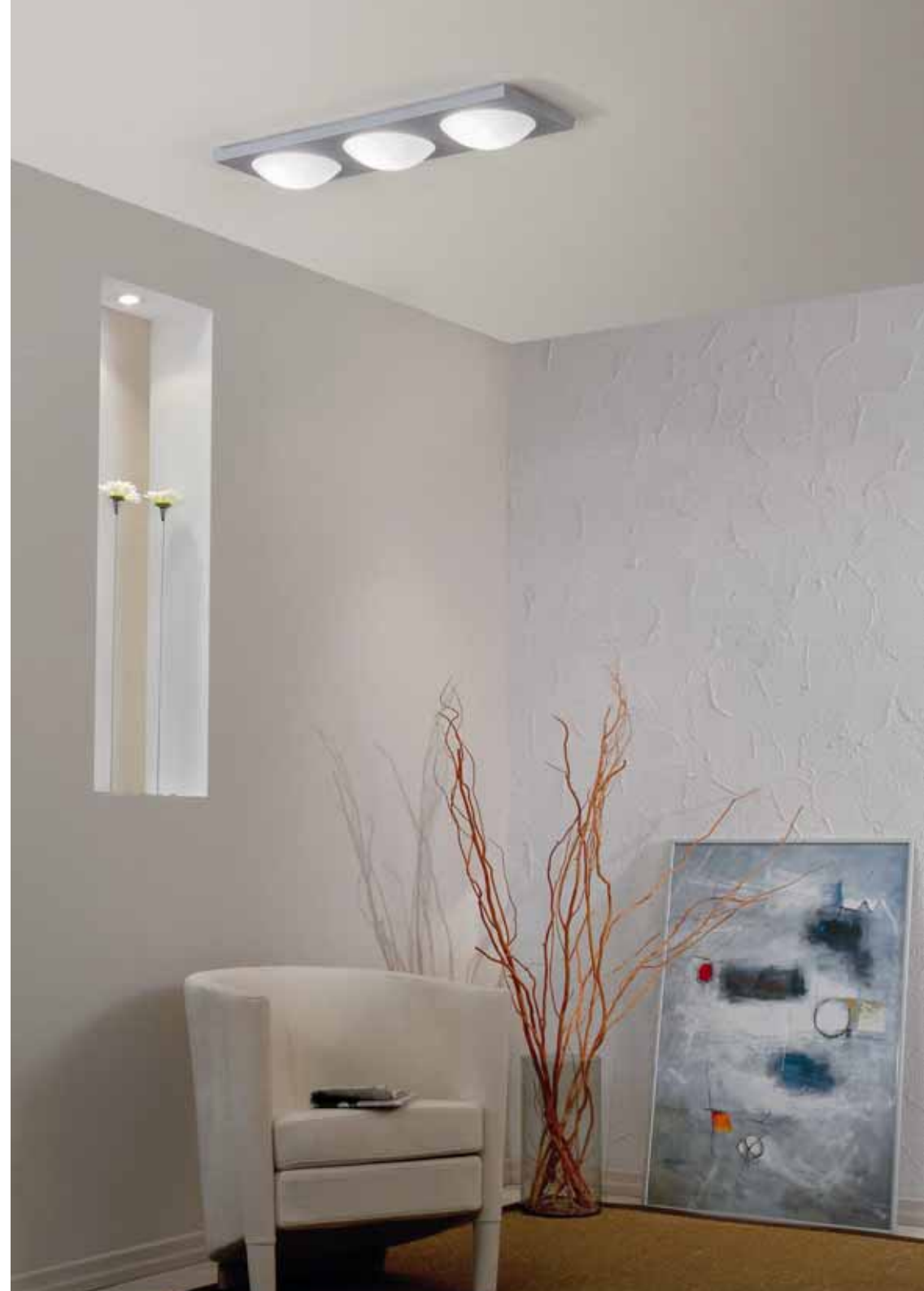
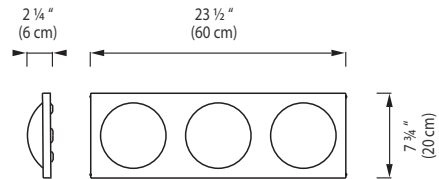

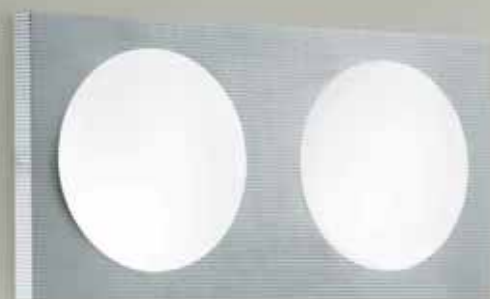



Diffuse light ceiling or wall lamp. Gray painted metal structure and opal satined blown glass.
Bayonet glass lens fastened.
Sealed with silicone rubber. IP44.

Éclairage plafonniers ou applique. Structure en métal verni gris, verre soufflé satiné opale.
Fixation du verre à baïonnette.
Les joints d'étanchéité sont en silicone. IP44.

Lámpara de techo y pared. Estructura en metal lacado gris y vidrio soplado opal satinado.
Fisaje del vidrio a bayoneta.
Juntas de goma siliconada para una perfecta estanqueidad. IP44.

MODEL	CATEGORY	FINISH	MAX WATTAGE	LAMP TYPE
D2-2040	CEILING / WALL	- SILVER GRAY	1x60 W	E26 A19
D2-2041	CEILING / WALL	- SILVER GRAY	2x60 W	E26 A19

D2-2040

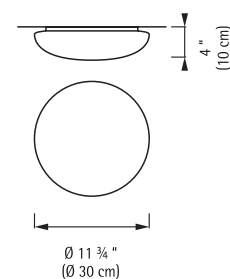

D2-2041

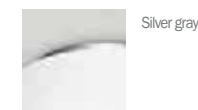
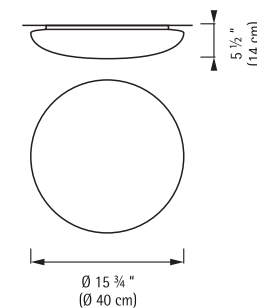

Wall or ceiling lamp.
Painted metal fixture.
Satined glass diffuser.

Plafonnier et applique à
lumière diffuse.
Structure en métal vernis.
Diffuseur en verre satiné.

Plafón y applique con luz
difundida.
Estructura de metal lacado.
Vidrio satinado.



MODEL	CATEGORY	FINISH	MAX WATTAGE	LAMP TYPE
ADA D2-2042	CEILING / WALL	- SILVER GRAY	1x60 W	E26 A19 
ADA D2-2043	CEILING / WALL	- SILVER GRAY	2x60 W	E26 A19 
ADA D2-2044	CEILING / WALL	- SILVER GRAY	3x60 W	E26 A19 

D2-2042 ADA

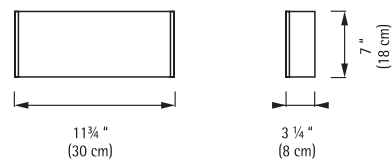

D2-2044 ADA

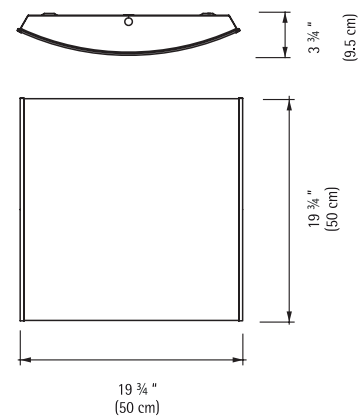

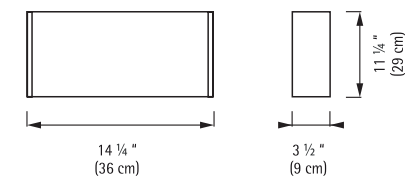

D2-2043 ADA



Wall and pendant lamps.
Blown satin glass.
Brushed nickel and
painted metal structure.

Série d'appliques et
suspensions.
Diffuseur en
verre soufflé satiné.
Structure en métal chromé
et verni.

Serie de lámpara de
pared y de suspensión.
Difusor en vidrio
soplado satinado.
Estructura en metal
cromado y barnizado.

MODEL	CATEGORY	FINISH	MAX WATTAGE	LAMP TYPE
D2-1010	PENDANT	- BRUSHED NICKEL	1x60 W	E26 A19 
ADA D2-3003	WALL	- BRUSHED NICKEL	1x100 W	E26 A19 

D2-1010

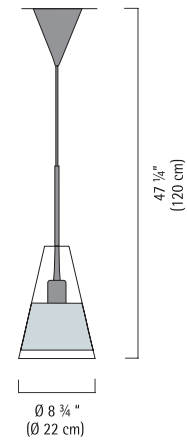

D2-3003 ADA

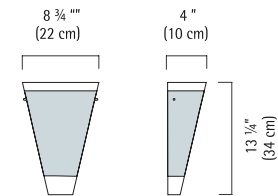

Wall lamp with diffused light, satin-finished glass diffusers, painted metal support.

Applique à lumière diffuse. Diffuseurs en verre satiné. Support en métal laqué.

Plafón de pared con luz difundida. Difusores en vidrio satinado. Soporte de metal lacado.

MODEL	CATEGORY	FINISH	MAX WATTAGE	LAMP TYPE
D2-3004	WALL	- CHROME	1x100 W	R7s T3Q/3 (79 mm)

D2-3004

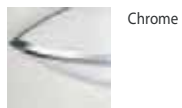
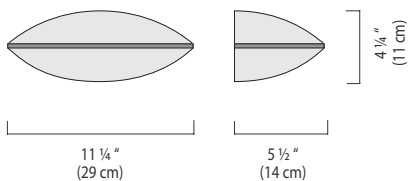

Wall lamp.
Thermoplastic support,
chrome glass holders.
Satinated glass diffuser.

Applique à lumière diffuse,
support en
thermoplastique, supports
verre chromés ou
laitonnés, diffuseur en
verre satiné.

Lámpara de pared con luz
difusa y directa. Soporte
termoplástico, soportes
del vidrio cromados o
bronceados. Vidrio
satinado.



	MODEL	CATEGORY	FINISH	MAX WATTAGE	LAMP TYPE
ADA	D2-3006	WALL	- CHROME	1x40 W	E12 B10
	D2-3007	WALL	- CHROME	1x100 W	E26 A19

D2-3006 ADA

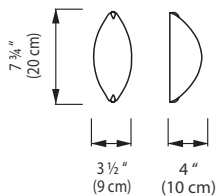

D2-3007

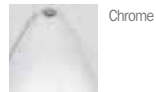
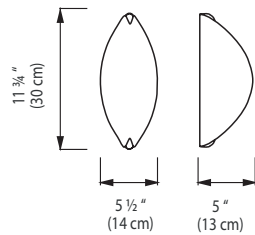

Diffuse light ceiling or wall
lamp. Painted metal
structure. Satined glass
diffuser. Also available
with PMMA diffuser.

Plafonnier et applique à
lumière diffuse, structure
en métal laqué.
Diffuseur en verre satiné.
Disponible aussi avec
PMMA diffuseur.

Plafón de techo o de
pared con luz difusa.
Estructura en metal
lacado barnizado.
Vidrio satinado. Disponible
también con difusor en
PMMA.



	MODEL	CATEGORY	FINISH	MAX WATTAGE	LAMP TYPE
ADA	D2-2007	CEILING / WALL	- SILVER GRAY	2x40 W	E26 A19
ADA	D2-2007H	CEILING / WALL	- SILVER GRAY	1x100 W	R7s T3Q (119mm)
	D2-2009	CEILING / WALL	- SILVER GRAY	2x75 W	E26 A19
	D2-2009H	CEILING / WALL	- SILVER GRAY	1x150 W	R7s T3Q (119mm)

**D2-2007
D2-2007H ADA**

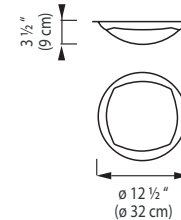

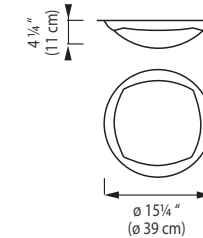

**D2-2009
D2-2009H**



Wall lamp. Metal painted support, satin-finished glass in the colors: amber and white.

Applique à lumière directe et diffuse. Support en métal. Diffuseur en verre satiné dans le coloris: opale et ambre.

Aplicador con luz difundida y directa. Estructura en metal. Difusor en vidrio satinado en los colores: ámbar y opal.

MODEL	CATEGORY	FINISH	MAX WATTAGE	LAMP TYPE
D2-3011	WALL	- WHITE	1x100 W	E26 A19 
D2-3012	WALL	- AMBER	1x100 W	E26 A19 

D2-3011
D2-3012

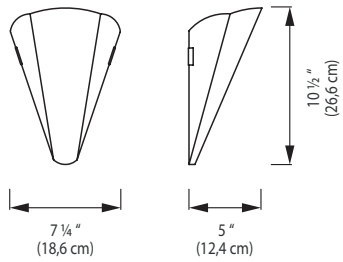
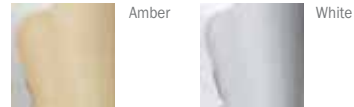



Ceiling or wall lamp. Painted metal support, nickel plated die cast glass-holders, satin finished glass diffuser.

Plafonnier ou applique à lumière diffuse. Support en métal laqué, supports verre en moulage sous pression nickelé ou laitonné mat, diffuseur en verre satiné.

Plafón de techo o pared con luz difusa. Soporte de metal barnizado y soportes del vidrio vaciados a presión niquelados o bronceados opacos. Vidrio satinado.



MODEL	CATEGORY	FINISH	MAX WATTAGE	LAMP TYPE
D2-2024	CEILING / WALL	- MATTE NICKEL	2x75 W	E26 A19 
D2-2024H	CEILING / WALL	- MATTE NICKEL	1x150 W	R7s T3Q (119mm) 

D2-2024
D2-2024H

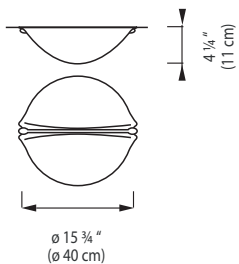



Ceiling or wall lamp. Brushed chrome metal frame, satin-finished glass diffuser.

Plafonnier ou applique à lumière diffuse, structure laqué en chrome brossé, diffuseur en verre satiné.

Plafón de techo o de pared con luz difusa. Estructura de cromo cepillado. Vidrio imprimido satinado.



MODEL	CATEGORY	FINISH	MAX WATTAGE	LAMP TYPE
ADA D2-2000	CEILING / WALL	- BRUSHED CHROME	2x40 W	E26 A19 
ADA D2-2000H	CEILING / WALL	- BRUSHED CHROME	1x100 W	R7s T3Q (119mm) 

D2-2000
D2-2000H **ADA**

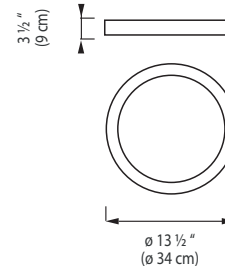

design Poom-Lab **Ring**

Ceiling or wall lamp.
Chromed plated metal
structure.
Screen-printed glass
diffuser.

Éclairage plafonnier ou
applique à lumière diffuse.
Structure métallique
vernée ou galvanisée. Verre
satiné sérigraphié.

Plafón de techo y de
pared.
Estructura metálica lacada
o galvanizada. Vidrio
satinado serigrafado.



MODEL	CATEGORY	FINISH	MAX WATTAGE	LAMP TYPE
ADA D2-2050	CEILING / WALL	- CHROME	1x60 W	E26 A19
D2-2051	CEILING / WALL	- CHROME	2x60 W	E26 A19



design Poom-Lab **Pocket**

Ceiling or wall lamp.
Chrome plated metal
glass support. Satin
finished glass diffuser.

Plafonnier ou applique à
lumière diffuse, support
laqué, diffuseur en verre
satiné.

Plafón de techo o de
pared con luz difusa.
Soporte de vidrio de metal
cromado o bronceado.
Vidrio satinado.



MODEL	CATEGORY	FINISH	MAX WATTAGE	LAMP TYPE
ADA D2-2048	CEILING / WALL	- BRUSHED CHROME	1x60 W	E26 A19
ADA D2-2049	CEILING / WALL	- BRUSHED CHROME	2x60 W	E26 A19

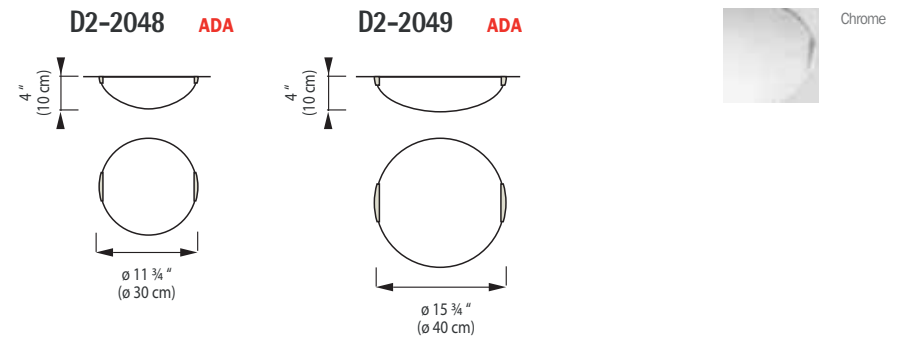



















INDEX D1		
CODE	CATEGORY	PAGE
D1-1000	PENDANT	29
D1-1001	PENDANT	40
D1-1003	PENDANT	34
D1-1005	PENDANT	54
D1-1006	PENDANT	38
D1-1010	PENDANT	44
D1-1011	PENDANT	60
D1-1012	PENDANT	60
D1-1013	PENDANT	60
D1-1014	PENDANT	60
D1-1015	PENDANT	60
D1-1016	PENDANT	60
D1-1026	PENDANT	31
D1-1027	PENDANT	48
D1-1028	PENDANT	48
D1-1029	PENDANT	48
D1-1030	PENDANT	08
D1-1031	PENDANT	08
D1-1032	PENDANT	08
D1-1033	PENDANT	08
D1-1037	PENDANT	14
D1-1038	PENDANT	24
D1-1046	PENDANT	20
D1-1047	PENDANT	20
D1-1048	PENDANT	04
D1-1049	PENDANT	04
D1-2000	FLUSH MOUNT	34
D1-2001	FLUSH MOUNT	54
D1-2002	FLUSH MOUNT	54
D1-2006	FLUSH MOUNT	70
D1-2014	FLUSH MOUNT	82
D1-2015	FLUSH MOUNT	82
D1-2016	FLUSH MOUNT	82
D1-2017	FLUSH MOUNT	82
D1-2018	FLUSH MOUNT	82
D1-2019	FLUSH MOUNT	82
D1-2020	FLUSH MOUNT	82
D1-2021	FLUSH MOUNT	82
D1-2022	FLUSH MOUNT	80
D1-2023	FLUSH MOUNT	80
D1-2025	FLUSH MOUNT	08
D1-2026	FLUSH MOUNT	08
D1-2035	FLUSH MOUNT	46
D1-2036	FLUSH MOUNT	46
D1-2039	FLUSH MOUNT	46
D1-2040	FLUSH MOUNT	46
D1-2044	FLUSH MOUNT	24
D1-2045	FLUSH MOUNT	74
D1-2046	FLUSH MOUNT	74
D1-2047	FLUSH MOUNT	74
D1-2048	FLUSH MOUNT	74
D1-2049	FLUSH MOUNT	74
D1-2050	FLUSH MOUNT	74
D1-2051	FLUSH MOUNT	74
D1-2052	FLUSH MOUNT	74
D1-2053	FLUSH MOUNT	74
D1-2054	FLUSH MOUNT	74

D1-2055	FLUSH MOUNT	74
D1-2056	FLUSH MOUNT	82
D1-2057	FLUSH MOUNT	82
D1-2058	FLUSH MOUNT	82
D1-2059	FLUSH MOUNT	24
D1-2060	FLUSH MOUNT	77
D1-2061	FLUSH MOUNT	77
D1-2062	FLUSH MOUNT	77
D1-2063	FLUSH MOUNT	77
D1-2064	FLUSH MOUNT	77
D1-2065	FLUSH MOUNT	77
D1-2066	FLUSH MOUNT	86
D1-2067	FLUSH MOUNT	86
D1-2068	FLUSH MOUNT	87
D1-2069	FLUSH MOUNT	87
D1-2070	FLUSH MOUNT	86
D1-2071	FLUSH MOUNT	86
D1-2072	FLUSH MOUNT	87
D1-2073	FLUSH MOUNT	87
D1-3001	WALL SCONCE	24
D1-3002	WALL SCONCE	20
D1-3005	WALL SCONCE	20
D1-3006	WALL SCONCE	04
D1-3017	WALL SCONCE	04
D1-3018	WALL SCONCE	04
D1-3019	WALL SCONCE	01
D1-3023	WALL SCONCE	01
D1-3027	WALL SCONCE	01
D1-3028	WALL SCONCE	01
D1-3030	WALL SCONCE	01
D1-3031	WALL SCONCE	01
D1-3032	WALL SCONCE	01
D1-3033	WALL SCONCE	01
D1-3034	WALL SCONCE	01
D1-3063	WALL SCONCE	01
D1-3064	WALL SCONCE	01
D1-3065	WALL SCONCE	01
D1-3066	WALL SCONCE	01
D1-3067	WALL SCONCE	01
D1-3069	WALL SCONCE	01
D1-3075	WALL SCONCE	01
D1-3076	WALL SCONCE	01
D1-3077	WALL SCONCE	01
D1-5000	WALL SCONCE	01
D1-5002	WALL SCONCE	01
D1-5003	WALL SCONCE	01
D1-5005	WALL SCONCE	01
D1-5007	WALL SCONCE	01
D1-5008	WALL SCONCE	01
D1-5010	WALL SCONCE	01
D1-5011	WALL SCONCE	01
D1-5012	WALL SCONCE	01
D1-5013	WALL SCONCE	01
D1-5014	WALL SCONCE	01
D1-5015	WALL SCONCE	01
D1-4014	PORTABLES	14
D1-4016	PORTABLES	14
D1-4018	PORTABLES	14

INDEX D2		
CODE	CATEGORY	PAGE
D2-1001	PENDANT	109
D2-1003	PENDANT	118
D2-1010	PENDANT	137
D2-1011	PENDANT	113
D2-1012	PENDANT	113
D2-1013	PENDANT	113
D2-1024	PENDANT	95
D2-1025	PENDANT	92
D2-1026	PENDANT	103
D2-1027	PENDANT	103
D2-1028	PENDANT	103
D2-2000	FLUSH MOUNT	145
D2-2000H	FLUSH MOUNT	145
D2-2007	FLUSH MOUNT	141
D2-2007H	FLUSH MOUNT	141
D2-2009	FLUSH MOUNT	141
D2-2009H	FLUSH MOUNT	141
D2-2024	FLUSH MOUNT	144
D2-2024H	FLUSH MOUNT	144
D2-2040	FLUSH MOUNT	133
D2-2041	FLUSH MOUNT	133
D2-2042	FLUSH MOUNT	135
D2-2043	FLUSH MOUNT	135
D2-2044	FLUSH MOUNT	135
D2-2045	FLUSH MOUNT	103
D2-2046	FLUSH MOUNT	103
D2-2047	FLUSH MOUNT	103
D2-2048	FLUSH MOUNT	147
D2-2049	FLUSH MOUNT	147
D2-2050	FLUSH MOUNT	146
D2-2051	FLUSH MOUNT	146
D2-3000	WALL SCONCE	109
D2-3003	WALL SCONCE	137
D2-3004	WALL SCONCE	138
D2-3005	WALL SCONCE	114
D2-3006	WALL SCONCE	140
D2-3007	WALL SCONCE	140
D2-3008	WALL SCONCE	116
D2-3010	WALL SCONCE	116
D2-3011	WALL SCONCE	142
D2-3012	WALL SCONCE	142
D2-3013	WALL SCONCE	113
D2-3014	WALL SCONCE	113
D2-3015	WALL SCONCE	113
D2-3020	WALL SCONCE	120
D2-3021	WALL SCONCE	120
D2-3022	WALL SCONCE	120
D2-3023	WALL SCONCE	124
D2-3024	WALL SCONCE	124
D2-3025	WALL SCONCE	124
D2-3026	WALL SCONCE	126
D2-3027	WALL SCONCE	126
D2-3030	WALL SCONCE	128
D2-3031	WALL SCONCE	128

D2-3032	WALL SCONCE	128
D2-3033	WALL SCONCE	128
D2-3034	WALL SCONCE	128
D2-3036	WALL SCONCE	95
D2-3037	WALL SCONCE	88
D2-3038	WALL SCONCE	90
D2-3039	WALL SCONCE	90
D2-3040	WALL SCONCE	90
D2-3041	WALL SCONCE	90
D2-3044	WALL SCONCE	90
D2-3045	WALL SCONCE	90
D2-3046	WALL SCONCE	101
D2-3048	WALL SCONCE	92
D2-3049	WALL SCONCE	92
D2-3050	WALL SCONCE	98
D2-3051	WALL SCONCE	107
D2-3052	WALL SCONCE	107
D2-4000	PORTABLE	109

CATEGORY	FUNCTIONS
D -1000	pendants
D -2000	flush mounts
D -3000	wall sconces
D -4000	portables
D -5000	bath lights
SIGN	
	approved by Canadian Standards Association for CSA and UL standards
	approved by Canadian Standards Association for CSA and UL standards
	WET LOCATION complies to american disability ACT

BULBS		
incandescent	  	E26 MEDIUM E12 CANDELABRA LAMP E26 BT15
halogen 120V	    	E12 XELOGEN E26 HALOGEN A R7s-T3Q/3 (79 mm) R7s-T3Q (119MM) G9
fluorescent	       	G24D 2G11 T5 FLUORESCENT GR10Q G24q2 T4 G24q3 T4 GX23-2 T4 2GX13 T5 CIRCLINE