

Q **U** **A** **S** **A** **R**

...CAN IT BE MORE NARROW?...CAN IT BE WIDER?...CAN IT BE BIGGER?...CAN IT BE SMALLER?
...IS THERE A POSSIBILITY TO GET IT IN SILVER?...GOLD?...ALSO STAINLESS STEEL?... BRONZE?
...BRASS?...CAN YOU HANG IT ON A WIRE?...CAN YOU DELIVER IT?...AND PICK IT UP?...IS IT
AVAILABLE IN VARIOUS COLOURS?...RED?...ARE YOU DOING THIS FOR A LONG TIME NOW?... DO
YOU INVENT IT ALL YOURSELF?...CAN YOU SWITCH IT ON?...CAN YOU SWITCH IT OFF?...

Yes!
e
s!

I **N** **D** **E** **X**

010 ALISTAIR
012 ALISTAIR
014 ALISTAIR
016 ALISTAIR
018 ARA
090 BELIGHT
122 BIRD
092 BOBBIN LACE
020 BOOGIEWOOGIE
124 CITADEL
126 CITADEL GRANDE
128 CITADEL COMPOSITION
022 CHACHACHA
024 COMPASS HALOGEN
026 COMPASS HALOGENB
028 COMPASS LED
030 CONSOLE
032 CUBE
034 CYPRES
036 CYPRES
094 DOCCIA
096 DOCCIA
038 EFQUS
040 EMILY
042 EMPIRE STATE
130 EXTASE
132 FIELTEBEK
134 FIELTEBEK SYSTEM
098 FLIGHT
044 FLOW
038 HAT
031 HELICON
032 HELICON
046 HELIOS
048 HIGH&MIGHTY
100 HYPPODROME

050 JUST THAT
052 JUST THAT
054 MADISON SQUARE
056 MADONNA
104 MAJOR TOM
058 MAXARA
106 MIRU
108 MIRU SPOT
110 MIRU XL
136 MOON
060 MUJAY
062 MUJAY
064 MURANISSIMO
138 NARITA KIN/GIN
066 NO.1
140 NOBILIS
112 ON-OFF LIGHT
142 ORKJE
144 ORK GRANDE
146 PAPYRUS
068 PENN
070 PILE
072 PILE
074 PORTOFINO
114 SOL-AIR
102 THE LINE
078 TOSCANA
116 TULIP
076 10 SPRIET
148 UNIVERSE
150 UNIVERSE SQUARE
080 WAVE
082 WINGS

QUASAR

C O L L E C T I O N



T I M E L E S S C E R T A I N O B J E C T F U N D A M E N T R E A L I T Y

Z E I T L O S S I C H E R O B J E K T G R U N D L A G E R E A L I T Ä T

I N T E M P O R E L S Ü R O B J E T F O N D E M E N T R É A L I T É

T I J D L O O S Z E K E R O B J E K T F U N D A M E N T E E L R E A L I T E I T





ALISTAIR

QUASAR COLLECTION

HANGLAMP

RVS en glas.

HÄNGELEUCHTE

Edelstahl und Glas.

SUSPENDED LAMP

Stainless steel and glass.

SUSPENSION

Acier inoxydable et verre Murano.

SMALL

4 X GU 5,3 HALOGEN / 20W

31 X E10 / 1,2 W

1 X G 6,35 HALOGEN / 35W

DESIGN: EDWARD VAN VLIET

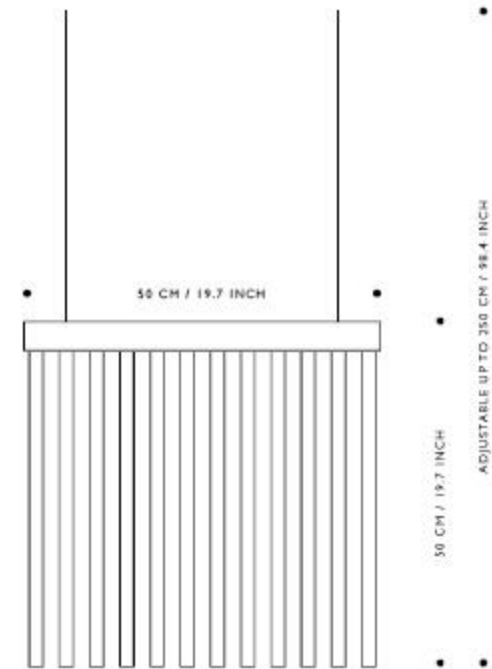



ALISTAIR

QUASAR COLLECTION

HANGLAMP

RVS en glas.

HÄNGELEUCHTE

Edelstahl und Glas.

SUSPENDED LAMP

Stainless steel and glass.

SUSPENSION

Acier inoxydable et verre Murano.

GRANDE

4 X GU 5.3 HALOGEN / 30W

95 X E10 / 1,2 W

1 X E14 / MINICOLORENTA

DESIGN: EDWARD VAN VLIET

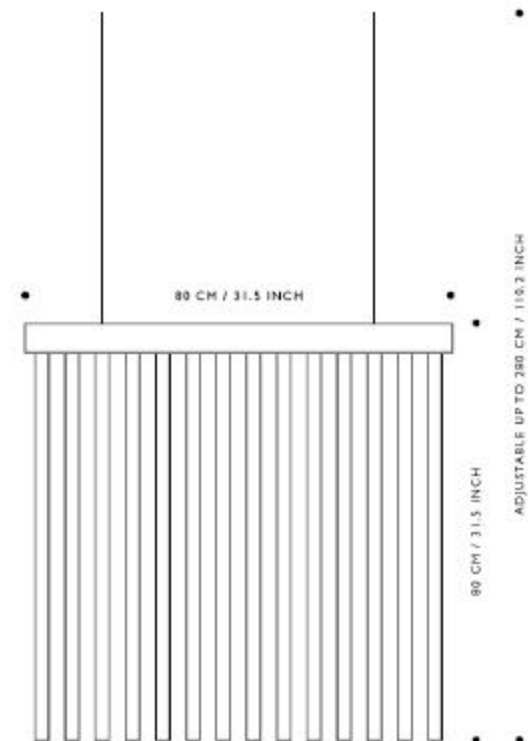
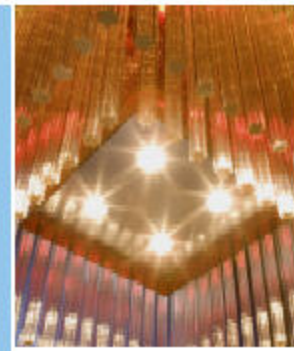



ALISTAIR

QUASAR COLLECTION

WANDLAMP
RVS en glas.

WANDLEUCHTE
Edelstahl und Glas.

WALL-LAMP
Stainless steel and glass.

APPLIQUE
Acier inoxydable et verre Murano.

GRANDE
1 X KRISTALINE 120W
35 X E10 / 1,2 W

SMALL
1 X KRISTALINE 60W
25 X E10 / 1,2 W

DESIGN: EDWARD VAN VLIET

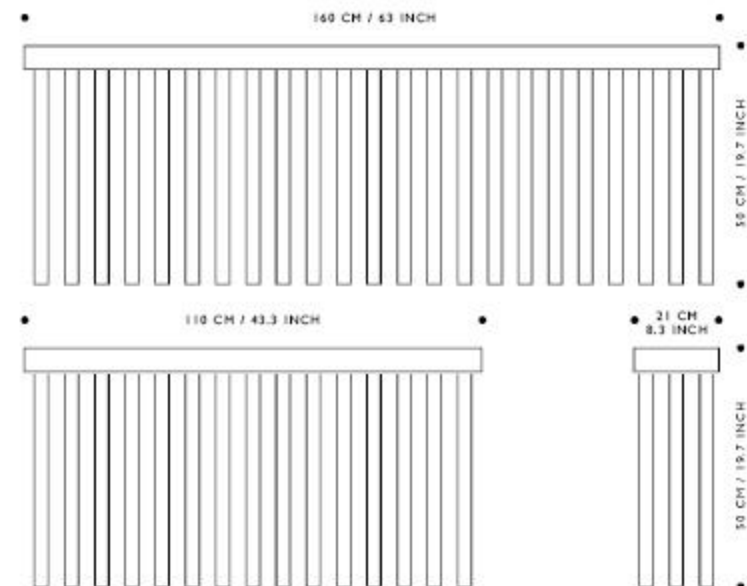



ALISTAIR

QUASAR COLLECTION

HANGLAMP

Gerealiseerd maatwerk.

HÄNGELEUCHTE

Realisierte Sonderanfertigung.

SUSPENDED LAMP

Realised special.

SUSPENSION

Edition spéciale en réalité.

DESIGN: EDWARD VAN VLIET

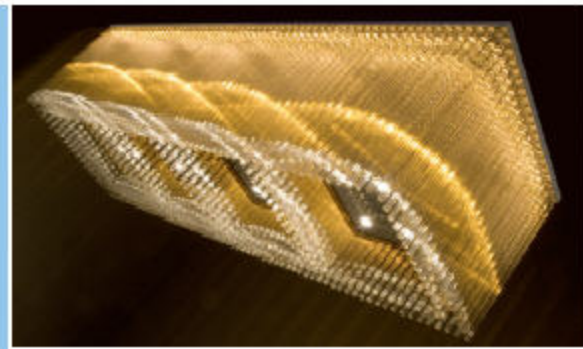

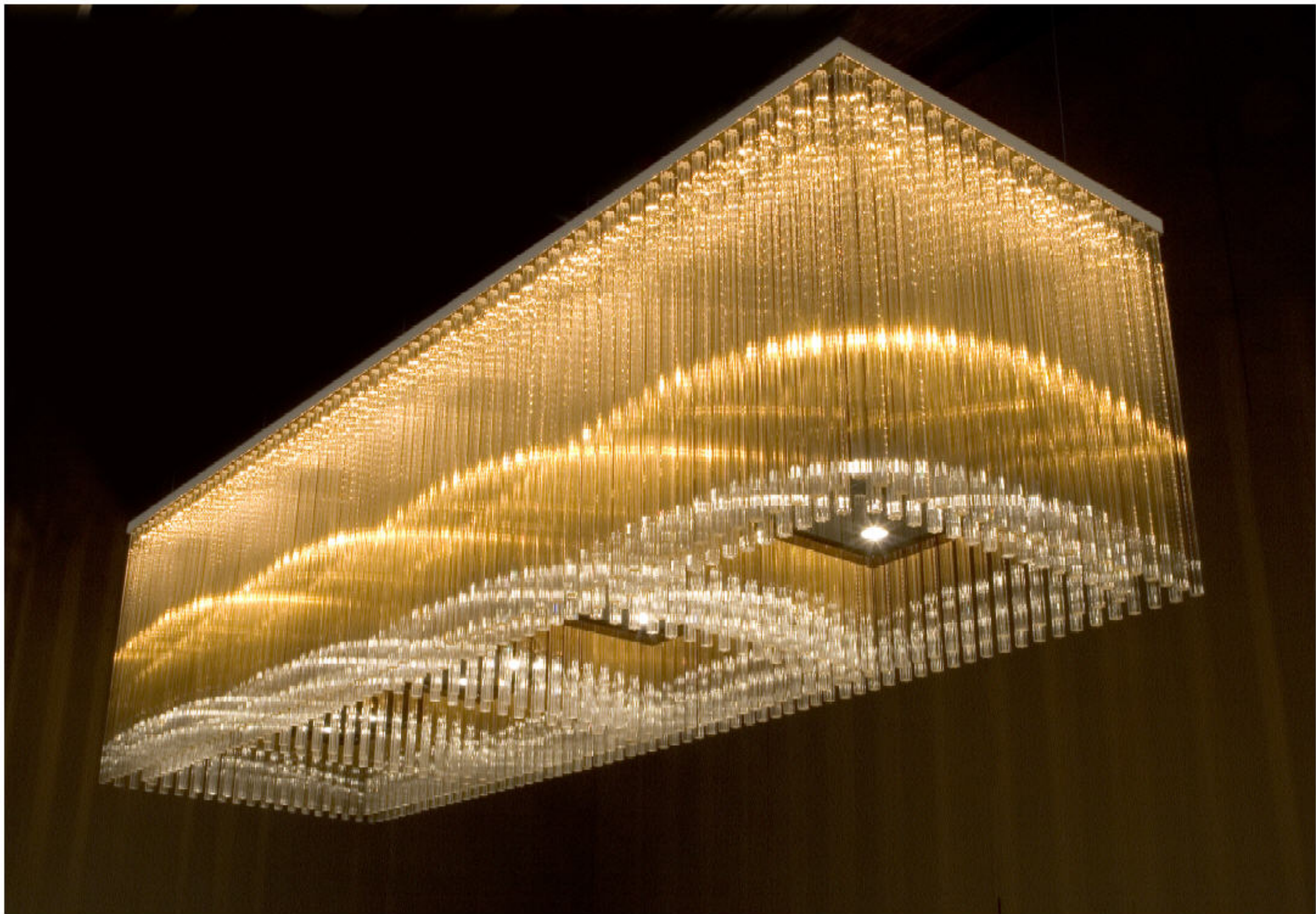

ARA

QUASAR COLLECTION

TAFELLAMP

Gegoten en gepolijst
aluminium of ruw brons.
Met dimmer.

TISCHLEUCHTE

Aluminiumguss poliert
oder Bronzeguss roh.
Mit Dimmer.

TABELLAMP

Cast aluminium polished
or cast bronze raw.
With dimmer.

LAMPE DE TABLE

Fusion d'aluminium poli
ou bronze brute.
Avec Variateur.

1 X G 6,35 HALOGEN / 35W

DESIGN: MIES & VAN GESSEL

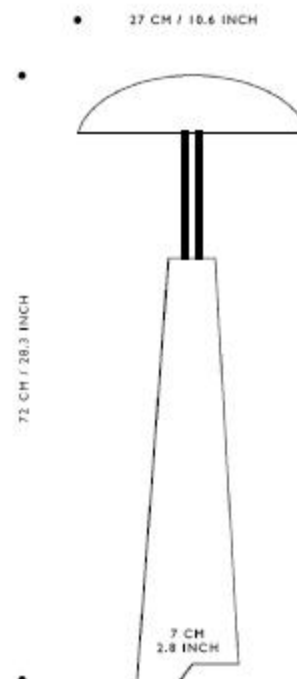
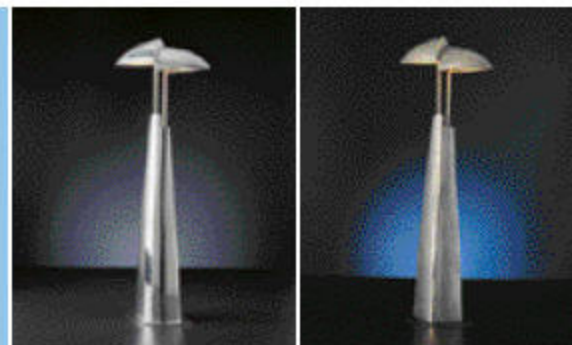

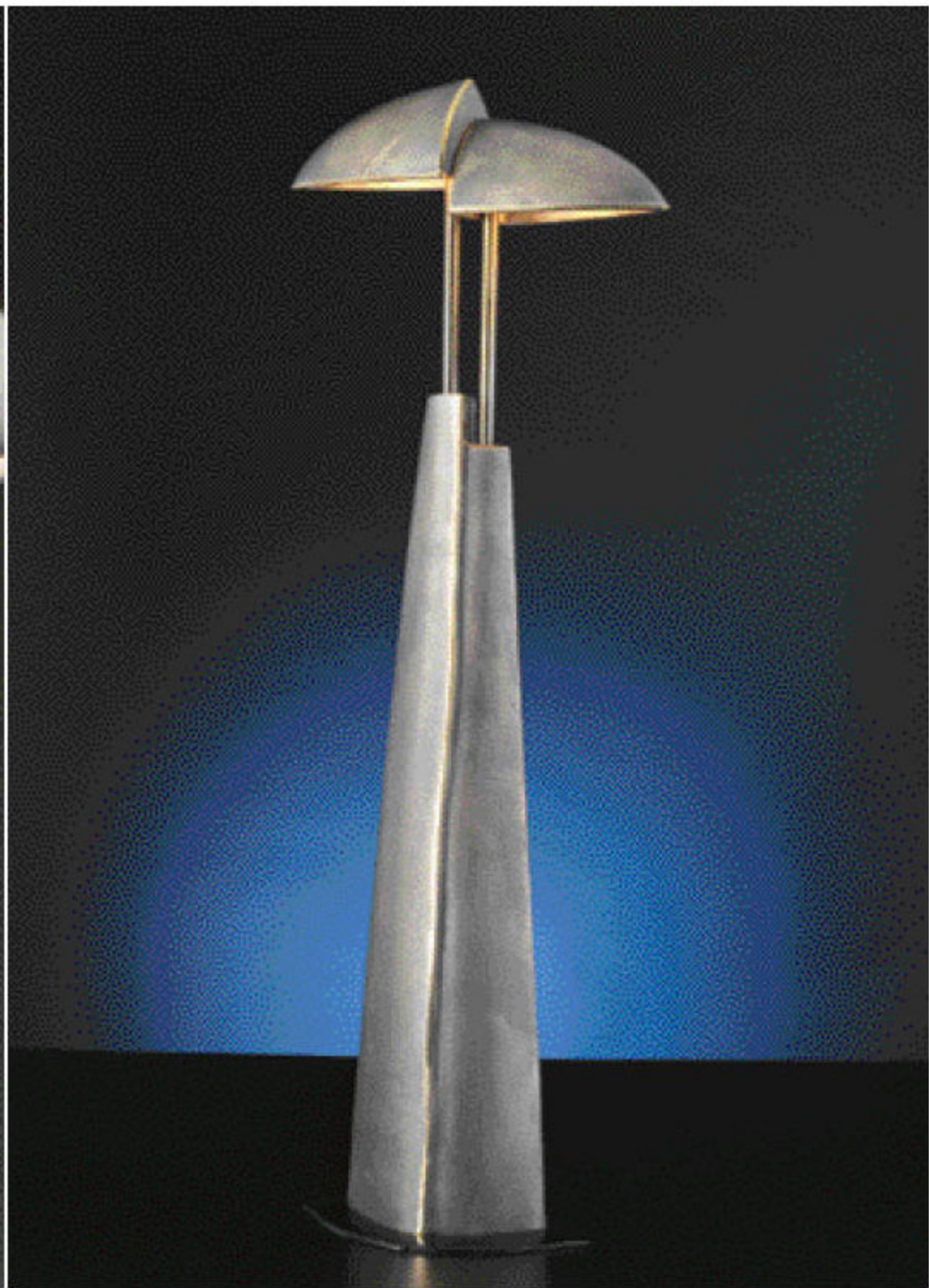

BOOGIE WOOGIE

QUASAR COLLECTION

TAFELLAMP

Geanodiseerd aluminium.
Kap met wit of gekleurd
zijdeband bewerkt en gecoat.
Met dimmer.

TISCHLEUCHTE

Aluminium eloxiert.
Schirm mit gefarbt oder weiss
Seidenband bearbeitet und
lackiert. Mit Dimmer.

TABLELAMP

Anodised aluminium.
Coloured or white silk tape
finished shade and lacquered.
With dimmer.

LAMPE DE TABLE

Aluminium anodisé.
Abat-jour recouvert de
soie naturel blanc ou coloré
et imperméabilisé anti statique.
Avec variateur.

SMALL | X E14 / 60W

BIG | X E27 / 60W

DESIGN: PAUL IMBRECHTS

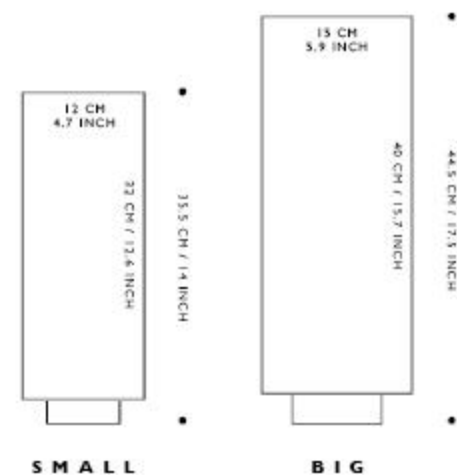



CHACHACHA

QUASAR COLLECTION

TAFELLAMP

Geanodiseerd aluminium.
Kap met zijdeband bewerkt
en gecoat.
Met dimmer.

TISCHLEUCHE

Aluminium eloxiert.
Schirm mit Seidenband
bearbeitet und lackiert.
Mit Dimmer.

TABLELAMP

Anodised aluminium.
Silk tape finished shade
and lacquered.
With dimmer.

LAMPE DE TABLE

Aluminium anodisé.
Abat-jour recouvert de soie
naturel et imperméabilisé
anti statique.
Avec variateur.

SMALL | X E14 / 60W

BIG | X E27 / 60W

DESIGN: PAUL INBRECHTS

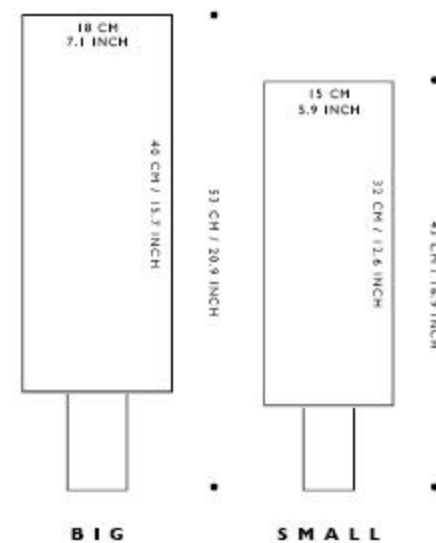



COMPASS HALOGEN

QUASAR COLLECTION

HANGLAMP

Gegoten en gepolijst aluminium.

HÄNGELEUCHTE

Aluminiumguss poliert.

SUSPENDED LAMP

Cast aluminium polished.

SUSPENSION

Fusion d'aluminium poli.

1 / 3 X G4 HALOGEN / 20W / D.35MM

DESIGN: JOS MULLER

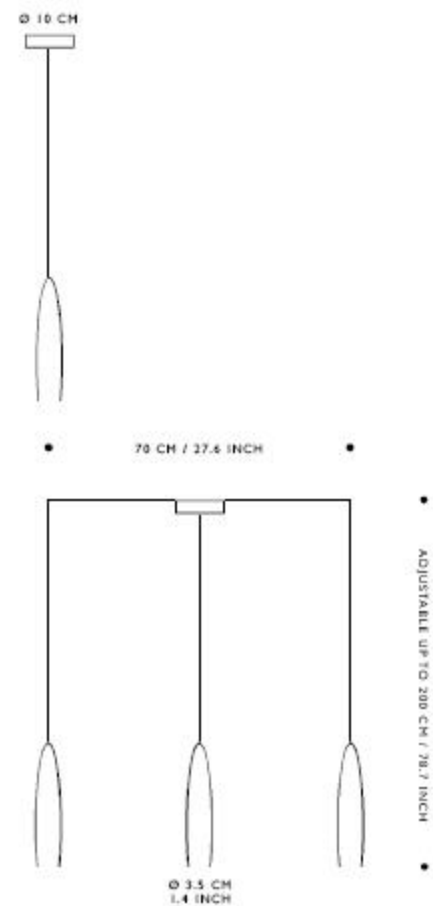



COMPASS HALOGEN 8

QUASAR COLLECTION

HANGLAMP

Gegoten en gepolijst aluminium.

HÄNGELEUCHTE

Aluminiumguss poliert.

SUSPENDED LAMP

Cast aluminium polished.

SUSPENSION

Fusion d'aluminium poli.

8 X G4 HALOGEN / 10W D. 25MM

DESIGN: JOS MULLER

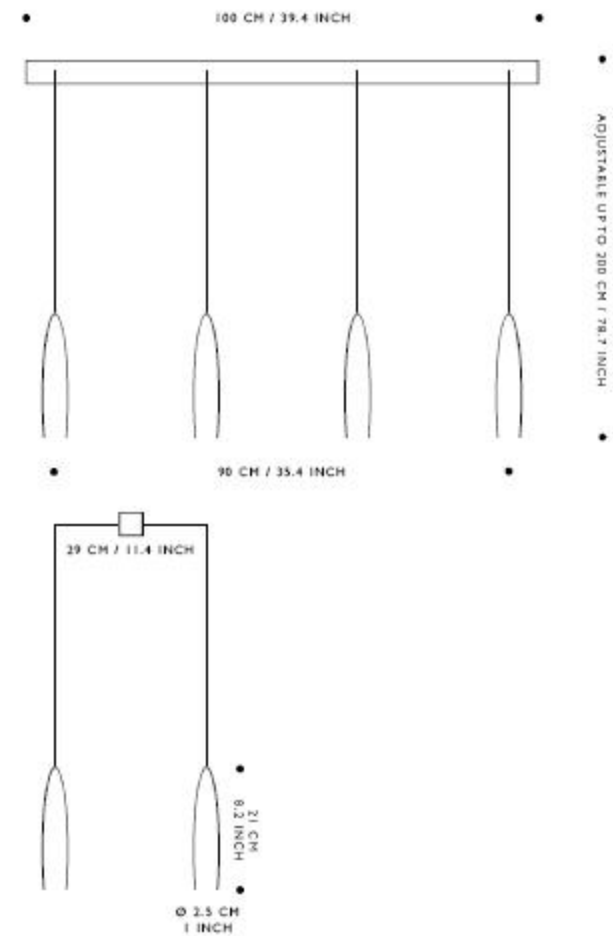



COMPASS LED

QUASAR COLLECTION

HANGLAMP

Gegoten en gepolijst aluminium.

HÄNGELEUCHTE

Aluminiumguss poliert.

SUSPENDED LAMP

Cast aluminium polished.

SUSPENSION

Fusion d'aluminium poli.

1 X POWERLED / 3W / WHITE

7 OR 15 X POWERLED / 1W

WHITE / WARM WHITE / RED / GREEN / BLUE

LENS 10° / 30° / 50°

DESIGN: JOS MULLER

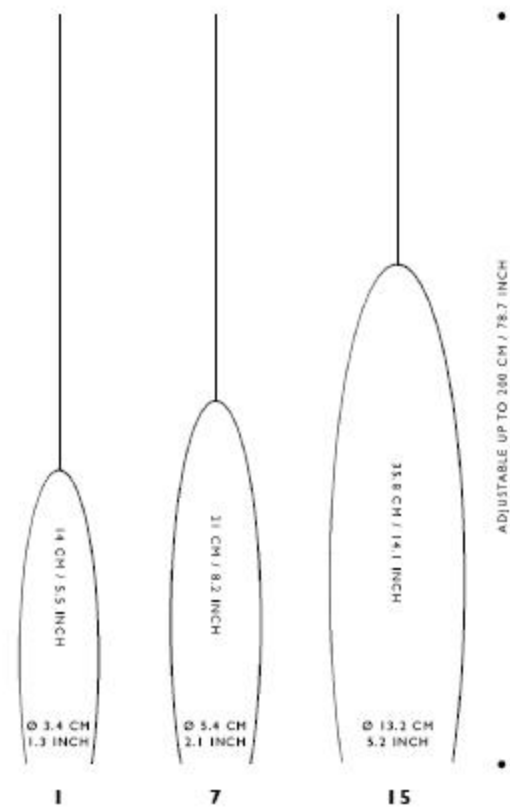



CONSOLE

QUASAR COLLECTION

TAFELLAMP

Gegoten ruw of gepolijst aluminium. Gegoten ruw of gedeeltelijk gepolijst brons. Murano glas helder of opaal.

TISCHLEUCHE

Aluminiumguss roh oder poliert. Bronzeguss roh oder teilweise poliert. Murano Glas klar oder opal.

TABELLAMP

Cast aluminium rough or polished. Cast bronze rough or partially polished. Murano glass clear or opal.

LAMPE DE TABLE

Fusion d'aluminium brute ou poli. Fusion de bronze brute ou partiellement poli. Verre de Murano.

1 X E27 / 60W

DESIGN: GERRIT HOLDIJK

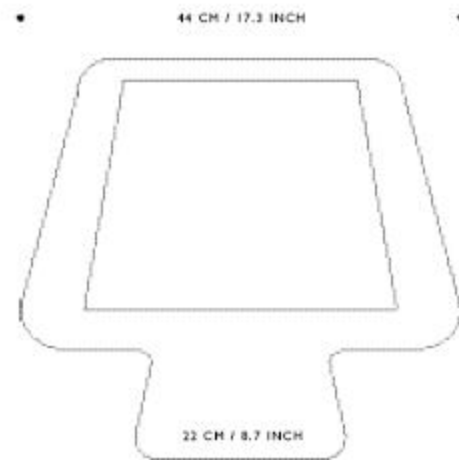
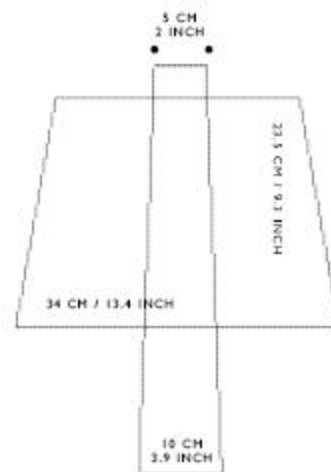

40 CM / 15.7 INCH



CUBE

QUASAR COLLECTION

TAFELLAMP

Aluminium en kristal.
Met dimmer.

TISCHLEUCHTE

Aluminium und Kristall.
Mit Dimmer.

TABLELAMP

Aluminium and crystal.
With dimmer.

LAMPE DE TABLE

Aluminium et cristal.
Avec variateur.

BIG | X E27 / PAR 30 / 100W

SMALL | X E27 / PAR 20 / 50W

DESIGN: ROB NOLLET

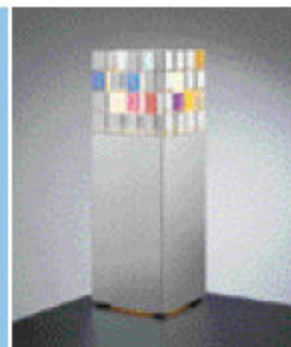

64 X

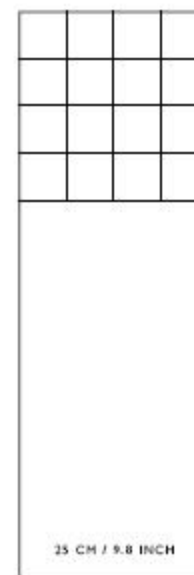
**BIG**

27 X

**SMALL**



CYPRES

QUASAR COLLECTION

VLOER- EN TAFELLAMP*

3 of 6 tops
RVS, aluminium en Murano glas.
Opaal of sfumato.
Met dimmer.

STEH- UND TISCHLEUCHTE*

3 oder 6 fach
Edelstahl, Aluminium und
Murano Glas.
Opal oder sfumato.
Mit Dimmer.

FLOOR- AND TABLELAMP*

3 or 6 elements
Stainless steel, aluminium
and Murano glass.
Frosted or sfumato.
With dimmer.

LAMPADAIRE ET LAMP DE TABLE*

3 ou 6 éléments
Acier inoxydable, aluminium
et verre de Murano.
Opale satiné ou sfumato.
Avec variateur.

3 / 6 X E14 / 40W

*3 / 6 X B15D / 15W

DESIGN: ROB NOLLET

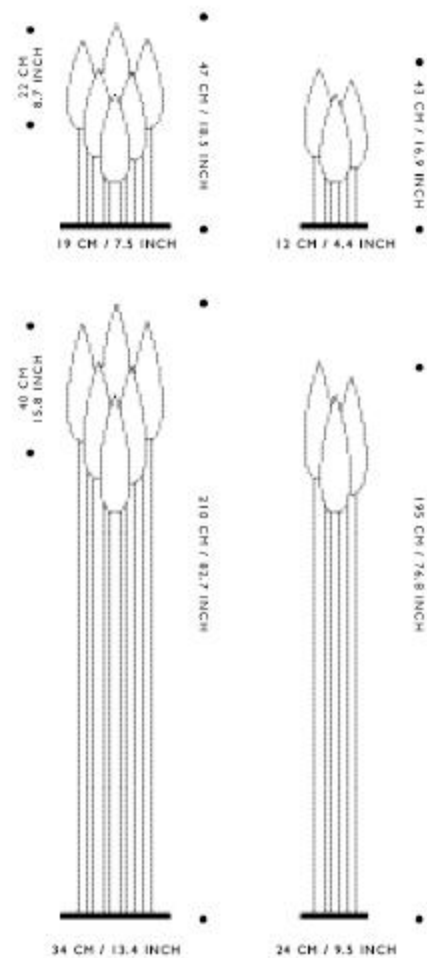
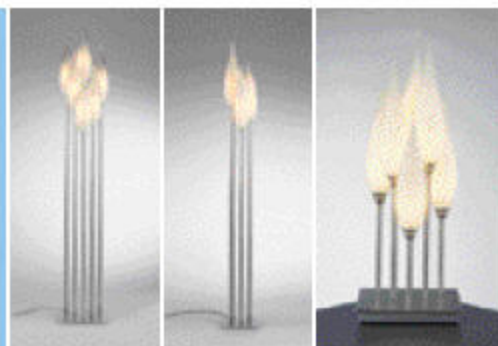

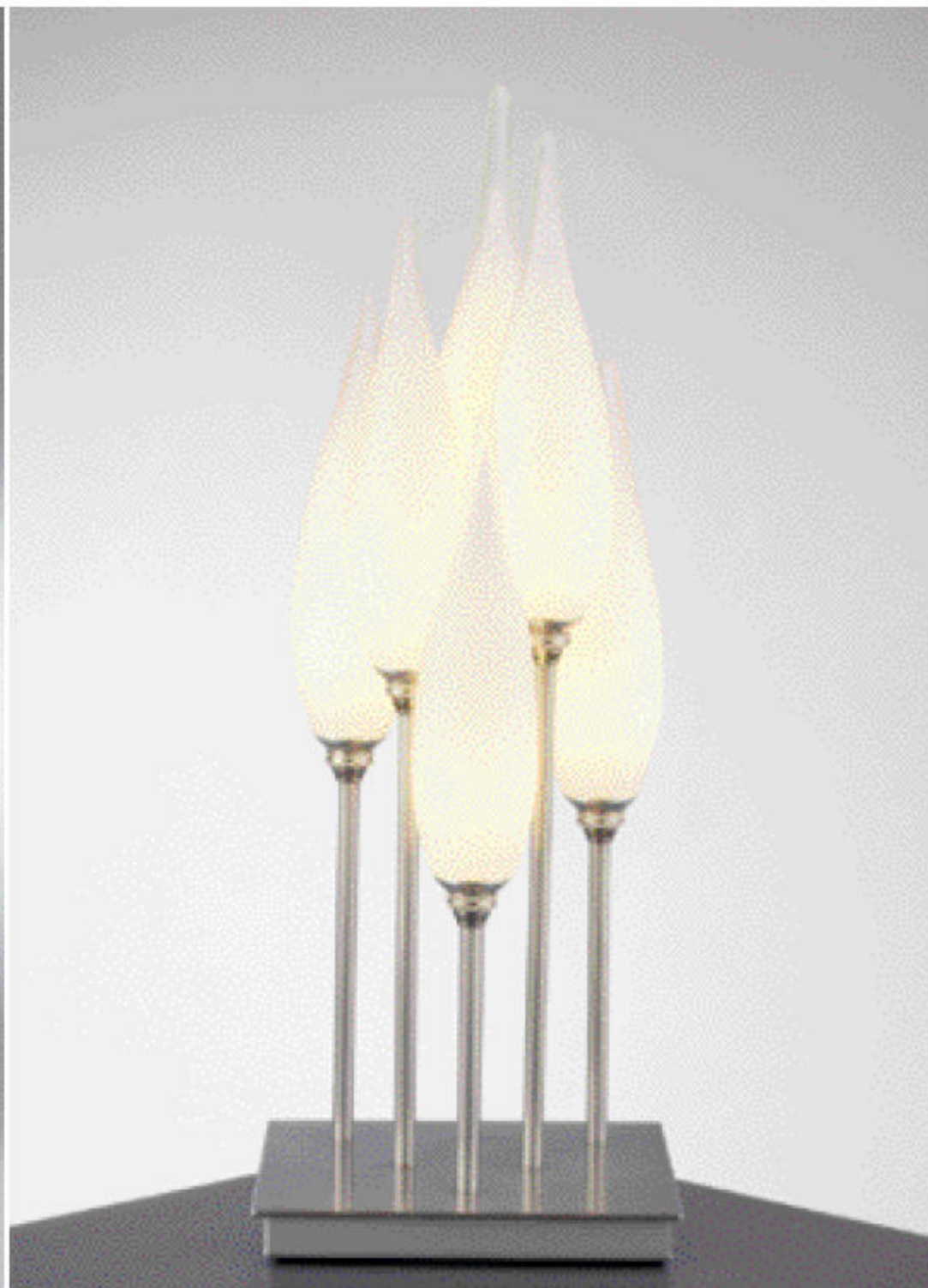

CYPRES

QUASAR COLLECTION

WANDLAMP

1, 3, 4, 6 or 12 tops
RVS en Murano-glas.
Opaal of sfumato

WANDLEUCHTE

1, 3, 4, 6 oder 12 fach
Edelstahl und Murano Glas
Opal oder sfumato

WALL-LAMP

1, 3, 4, 6 or 12 elements
Stainless steel and
Murano glass.
Frosted or sfumato

APPLIQUE

1, 3, 4, 6 ou 12 éléments
Acier inoxydable et
verre de Murano.
Opale satiné ou sfumato.

1 - 12 x B15d / 15W

DESIGN: ROB NOLLET

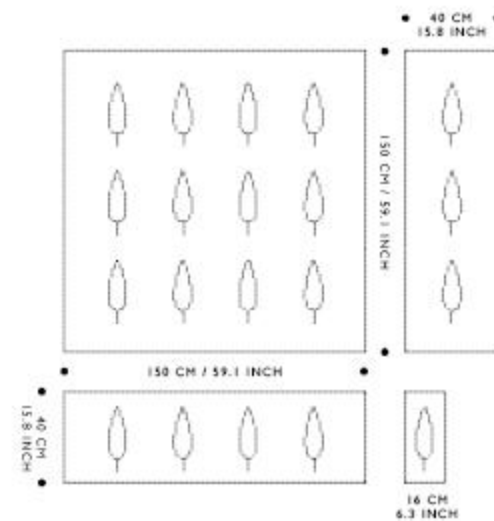
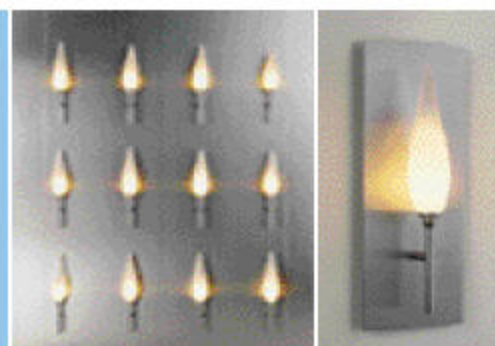

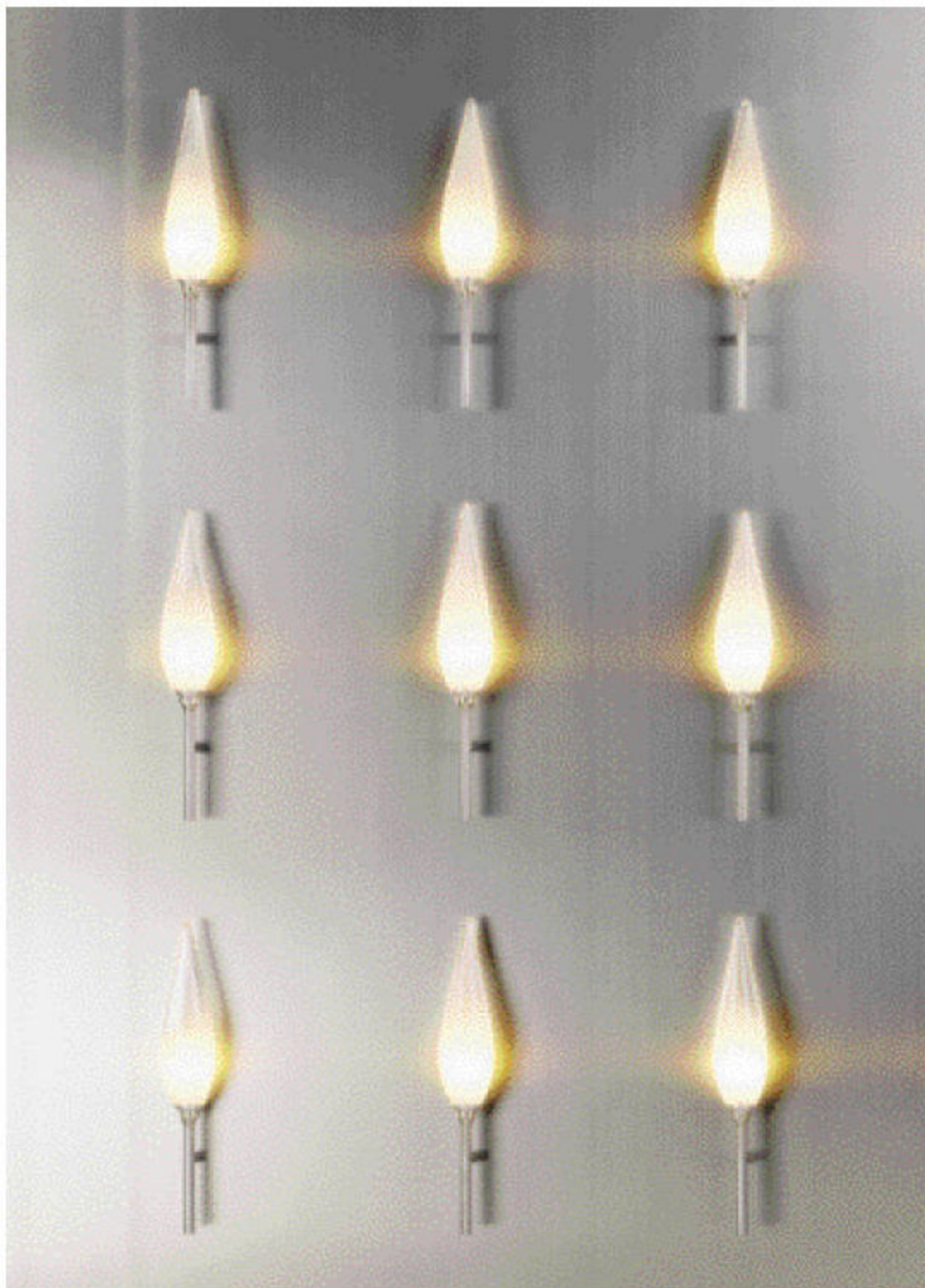

EFQUS

QUASAR COLLECTION

VLOER-, TAFEL- EN HANGLAMP

RVS en aluminium.

Kap naturel katoen velours.

Hanglamp in hoogte instelbaar.

Vloer- en tafellamp met dimmer.

STEH-, TISCH- UND HÄNGELEUCHTE

Edelstahl und Aluminium.

Schirm aus Baumwolle-Velours.

Hängeleuchte mit instellbarer Höhe.

Steh- und Tischleuchte mit Dimmer.

**FLOOR-, TABLE- AND
SUSPENDED LAMP**

Stainless steel and aluminium.

Shade cotton-velour.

Suspended lamp is adjustable.

Floor- and tablelamp with dimmer.

**LAMPADAIRE, LAMPE DE TABLE ET
SUSPENSION**

Acier inoxydable et aluminium.

Abat-jour en coton-velours.

Suspension réglables en hauteur.

Lampadaire et lampe de table

avec variateur.

30 CM / 11.8 INCH

45 CM / 17.7 INCH

60 CM / 23.6 INCH

DESIGN: JAN DES BOUVRIE

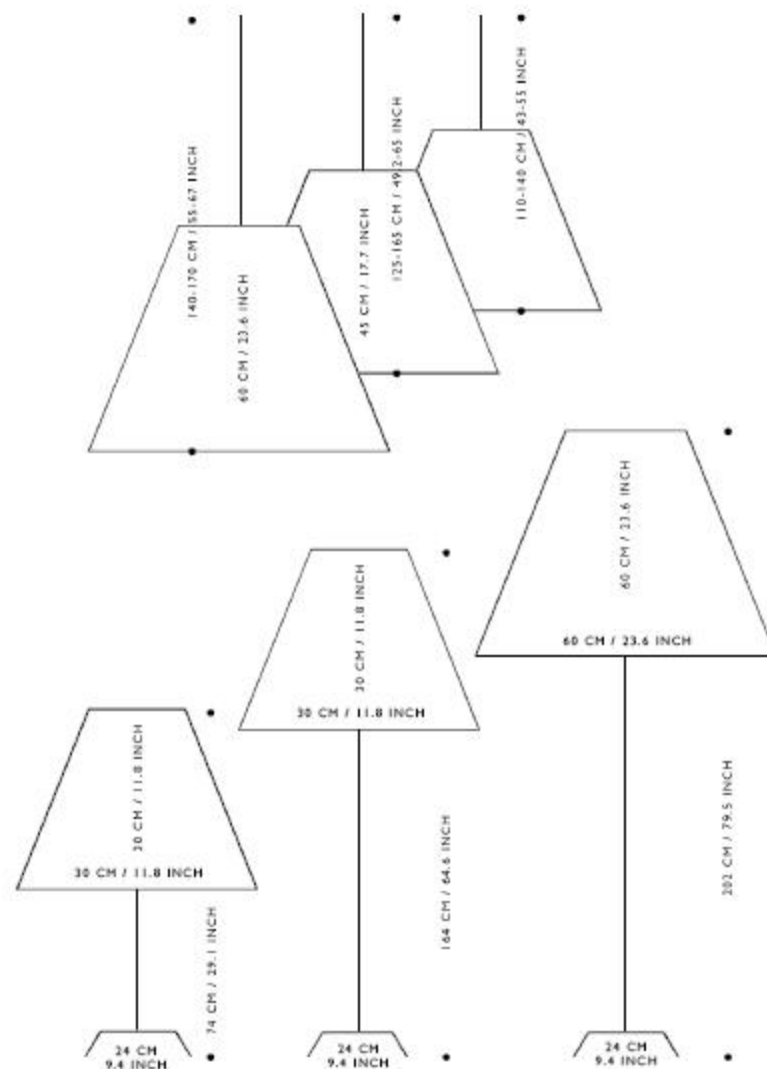



EMILY

QUASAR COLLECTION

**VLOER-, TAFEL-,
HANG- EN WANDLAMP.**
Geanodiseerd aluminium en RV5.
Vloer- en tafellamp
met dimmer.

**STEH-, TISCH-, HÄNGE- UND
WANDLEUCHTE.**
Aluminium eloxiert
und Edelstahl.
Steh- und Tischleuchte
mit Dimmer.

**FLOOR-, TABLE-, WALL-LAMP
OR SUSPENSION.**
Anodised aluminium
with stainless steel.
Floor and tablelamp
with dimmer.

**LAMPADAIRE, LAMPE DE TABLE,
SUSPENSION ET APPLIQUE.**
Aluminium anodisé
avec acier inoxydable.
Lampadaire et lampe
de table avec variateur.

I X PAR 20 / 50W
I X PAR 20 / 75W (VLOERLAMP /
STEHLEUCHTE / FLOORLAMP /
LAMPADAIRE)

DESIGN: BUANEY VOELERIJ

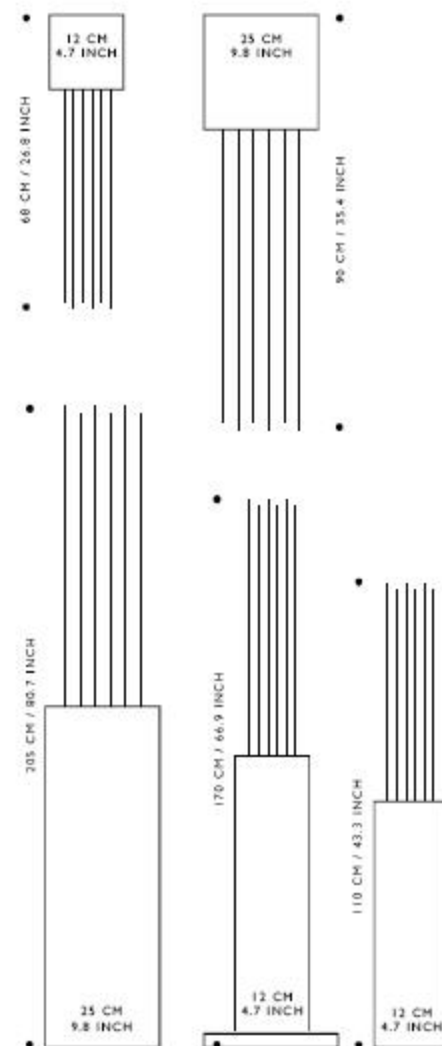



EMPIRE STATE

QUASAR COLLECTION

TAFELLAMP

RVS gepolijst / mat
en hoogglans zwart.
Glas opaline.
Met dimmer.

TISCHLEUCHE

Edelstahl poliert / matt
und hochglanz schwarz.
Glas Opaline.
Mit Dimmer.

TABELLAMP

Stainless steel polished /
frosted and glossy black.
Glass opaline.
With dimmer.

LAMPE DE TABLE

Acier inoxydable poli /
matité et noire brillant.
Verre opaline.
Avec variateur.

1 X E27 / 60W

DESIGN: RAVAGE

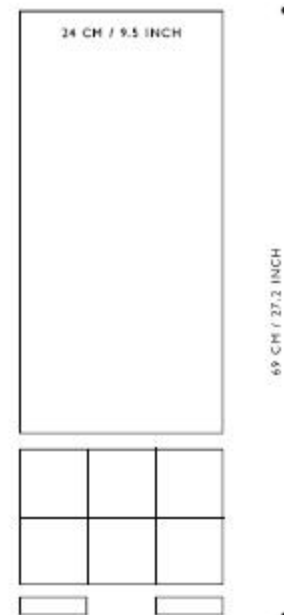



FLOW

QUASAR COLLECTION

VLOER-, TAFEL- EN HANGLAMP

RVS en metaalzijde.

Hanglamp in hoogte instelbaar.

Vloer- en tafellamp met dimmer.

STEH-, TISCH- EN HÄNGELEUCHTE

Edelstahl und Metallseide.

Hängeleuchte mit instellbarer Höhe.

Steh- und Tischleuchte mit Dimmer.

FLOOR-, TABLE- OR SUSPENDED LAMP

Stainless steel and metalsilk.

Suspended lamp is adjustable.

Floor and tablelamp with dimmer.

LAMPADAIRE, LAMPE DE TABLE* ET SUSPENSION

Acier inoxydable et tissu soie
avec fil de métal.

Suspension réglables en hauteur.

Lampadaire et lampe de table
avec variateur.

I X E27 / 75W HALOGEN

*I X GY 6.35 HALOGEN / 50W / 12V

DESIGN: MARC DE GROOT

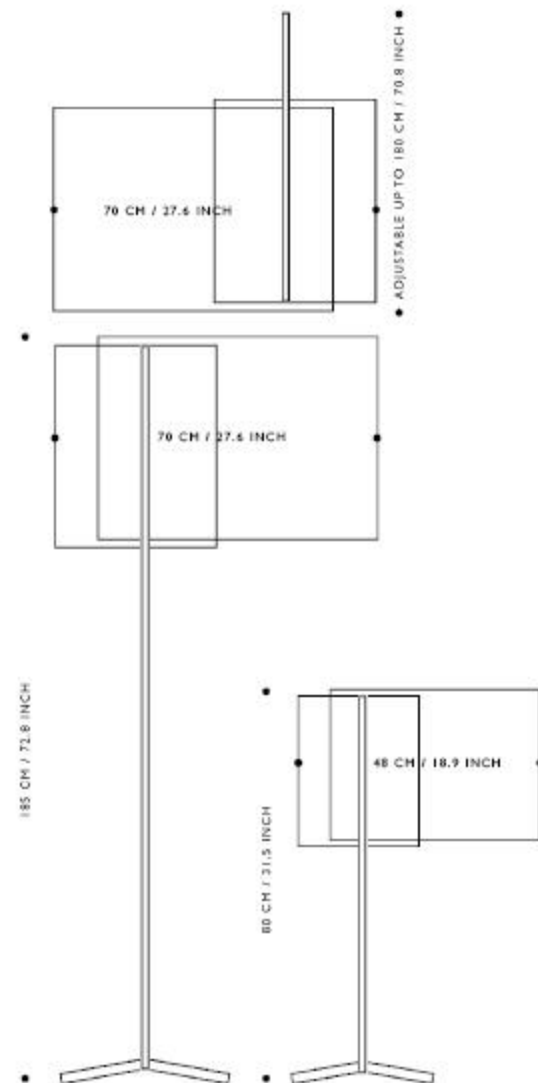



HELIOS

QUASAR COLLECTION

HANGLAMP
RVS en aluminium.

HÄNGELEUCHTE
Edelstahl und Aluminium.

SUSPENDED LAMP
Stainless steel and aluminium.

SUSPENSION
Acier inoxydable et aluminium.

10 X E27 / 40W REFLECTOR

DESIGN: ROB MOLLET

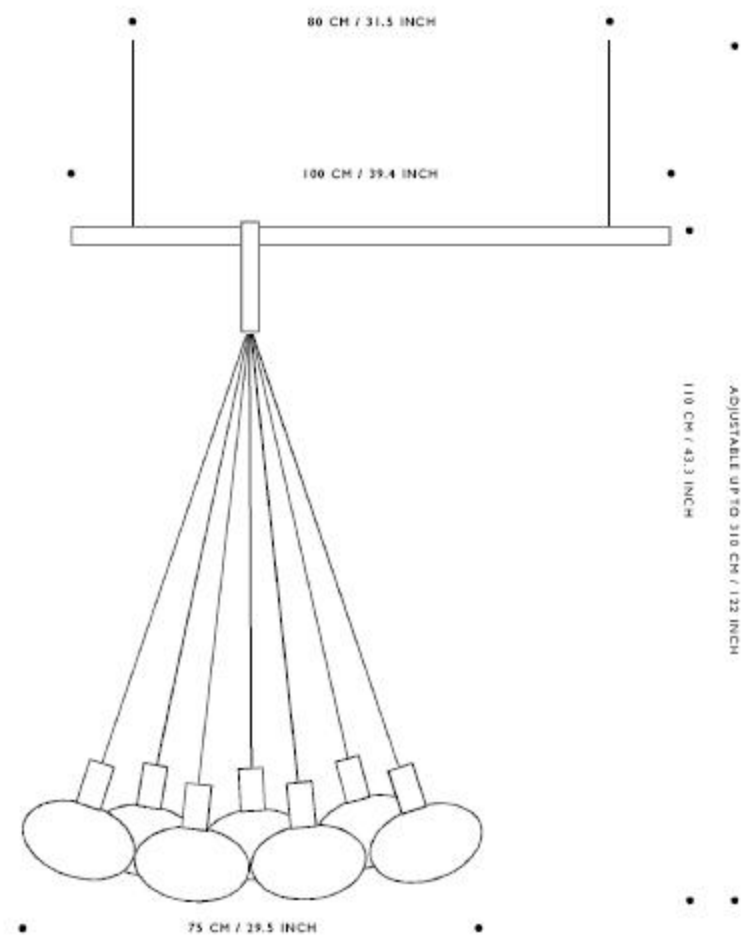





HIGH & MIGHTY

QUASAR COLLECTION

VLOERLAMP

Geanodiseerd aluminium.
Kap met zijdeband bewerkt
en gecoat.
Met dimmer.

STEHLEUCHTE

Aluminium efoxiert.
Schirm mit Seidenband
bearbeitet und lackiert.
Mit Dimmer.

FLOORLAMP

Anodised aluminium.
Silk tape finished shade
and lacquered.
With dimmer.

LAMPADAIRE

Aluminium anodisé.
Abat-jour recouvert de
soie naturel et imperméabilisé
anti statique.
Avec variateur.

5 X E27 / 60W

DESIGN: PAUL INBRECHTS



16 CM
6.3 INCH

181 CM / 71.3 INCH

30 CM / 11.8 INCH

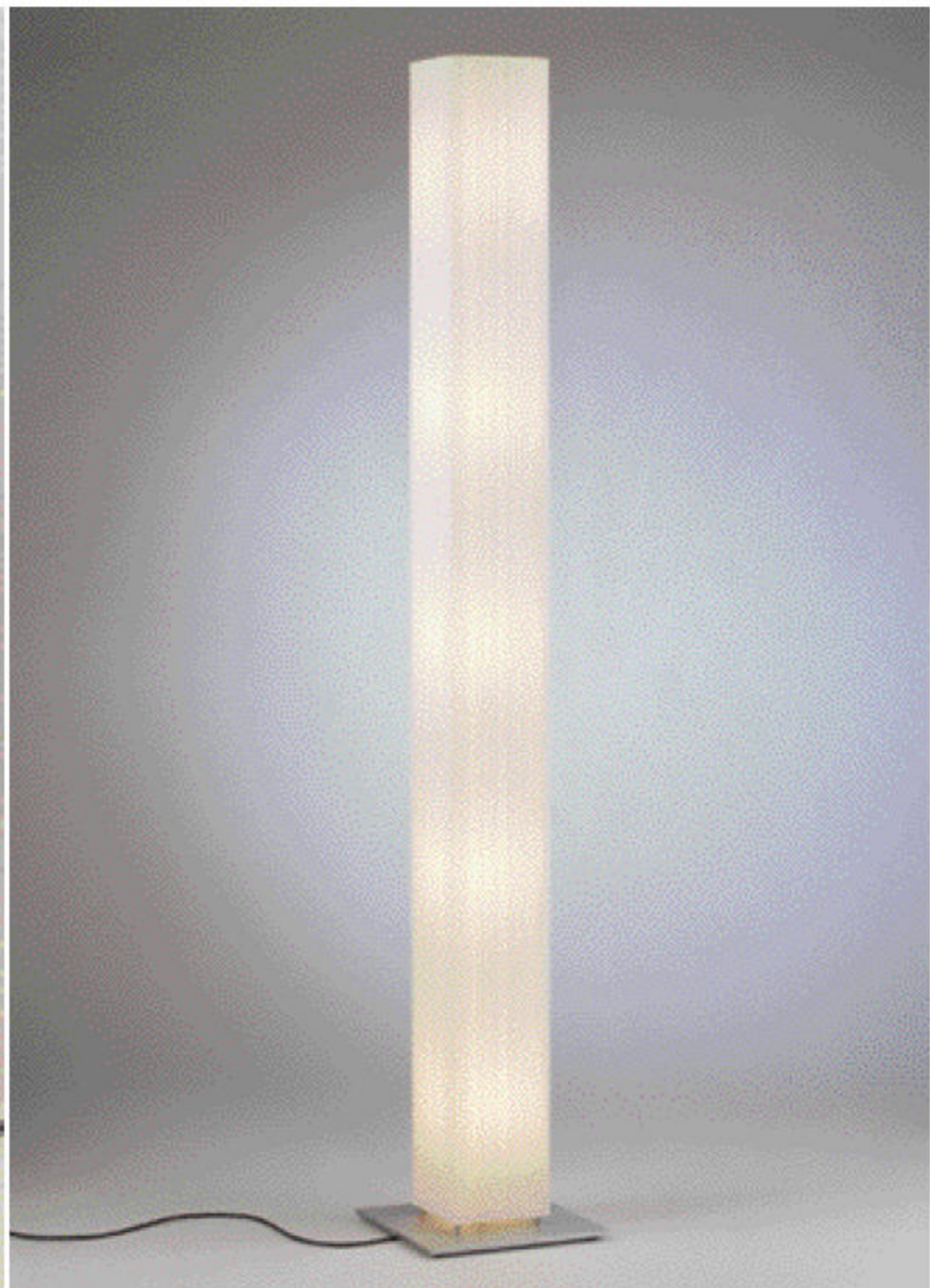

JUST THAT

QUASAR COLLECTION

WANDLAMP: MURANOGLAS 6

HANGLAMP 3 OF 5: MURANOGLAS 4

GIETSTUKKEN

STANG

Aluminium ruw

gegalvaniseerd

Aluminium gepolijst

RVS

Bronze ruw

messing

WANDLEUCHTE: MURANOGLAS 6

HÄNGELEUCHTE 3 ODER 5: MURANOGLAS 4

GUSSTEILEN

STANGE

Aluminium roh

galvanisiert

Aluminium poliert

Edelstahl

Bronze roh

Messing

WALL-LAMP: MURANOGLASS 6

SUSPENDED LAMP 3 OR 5: MURANOGLASS 4

CASTWORK

BAR

Aluminium raw

zinc

Aluminium polished

stainless steel

Bronze raw

brass

APPLIQUE: VERRE DE MURANO 6

SUSPENSION 3 OU 5: VERRE DE MURANO 4

CORPS

BARRE

Aluminium brut

galvaniser

Aluminium poli

acier inoxydable

Bronze brut

laiton

GLASS 4 / G9 HALOGEN / MAX. 40W

GLASS 6 / G9 HALOGEN / MAX. 60W

DESIGN: ROB NOLLET

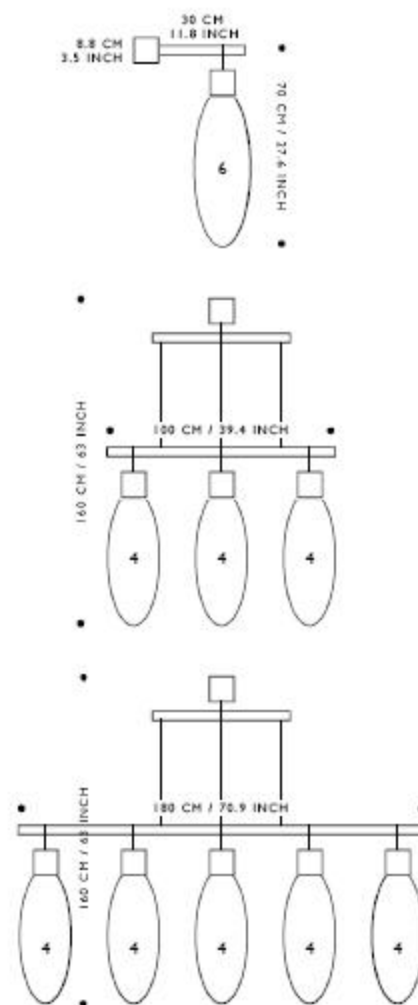

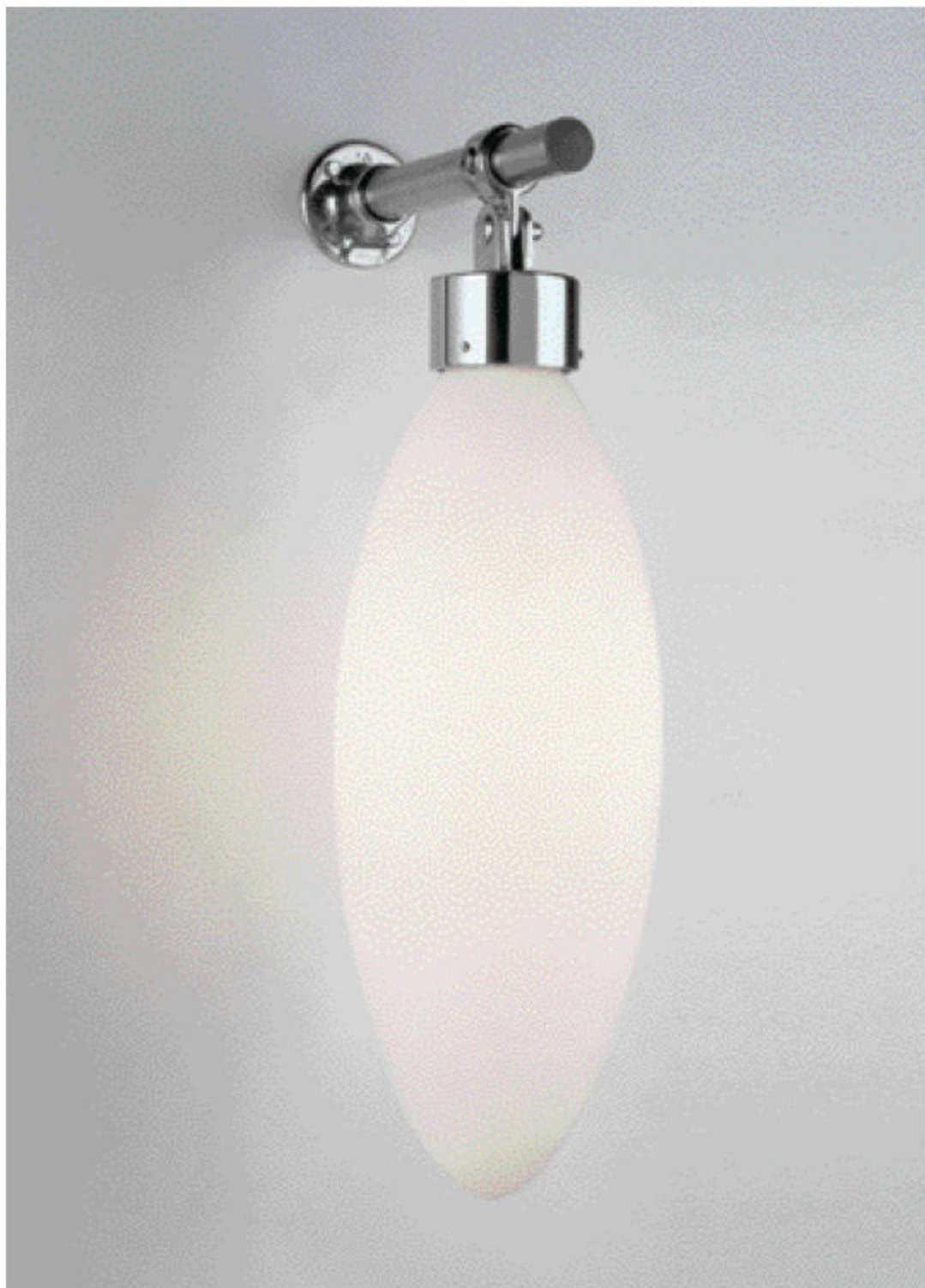



JUST THAT

QUASAR COLLECTION

A. WANDLAMP / MURANOGLAS 3 OF 4
 B. HANGLAMP / MURANOGLAS 3/4 OF 6
 C/D. HANGLAMP / MURANOGLAS 3 EN 4
 E. VLOERLAMP / MURANOGLAS 6 (NIET IN BRONS)
 GIETSTUKKEN KETTING
 Aluminium ruw gegalvaniseerd
 Aluminium gepolijst RVS
 brons ruw messing

A. WANDLEUCHTE / MURANOGLAS 3 ODER 4
 B. HÄNGELEUCHTE / MURANOGLAS 3/4 ODER 6
 C/D. HÄNGELEUCHTE / MURANOGLAS 3 UND 4
 E. STEHLEUCHTE / MURANOGLAS 6 (NICHT IN BRONZE)
 GUSSTEILEN KETTE
 Aluminium roh galvanisiert
 Aluminium poliert Edelstahl
 Bronze roh Messing

A. WALL-LAMP / MURANOGLASS 3 OR 4
 B. SUSPENDED LAMP / MURANOGLASS 3/4 OR 6
 C/D. SUSPENDED LAMP / MURANOGLASS 3 AND 4
 E. FLOORLAMP / MURANOGLASS 6 (NO BRONZE)
 CASTWORK CHAIN
 Aluminium raw zinc
 Aluminium polished stainless steel
 Bronze raw brass

A. APPLIQUE / VERRE DE MURANO 3 OU 4
 B. SUSPENSION / VERRE DE MURANO 3/4 OU 6
 C/D. SUSPENSION / VERRE DE MURANO 3 ET 4
 E. LAMPADAIRE / VERRE DE MURANO 6 (PAS EN BRONZE)
 CORPS CHAÎNE
 Aluminium brut galvaniser
 Aluminium poli acier inoxydable
 Bronze brut laiton

GLASS 3 / G9 HALOGEN / MAX. 25W
 GLASS 4 / G9 HALOGEN / MAX. 40W
 GLASS 6 / G9 HALOGEN / MAX. 60W

DESIGN: ROB NOLLET

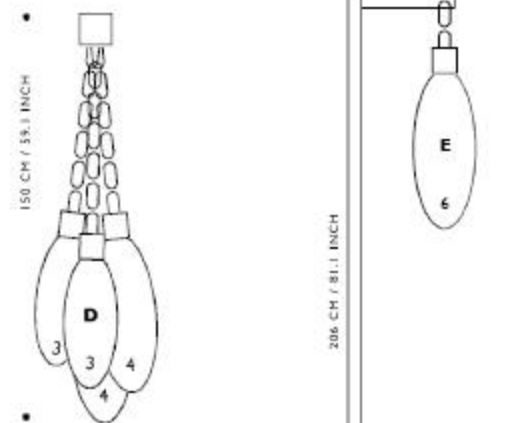
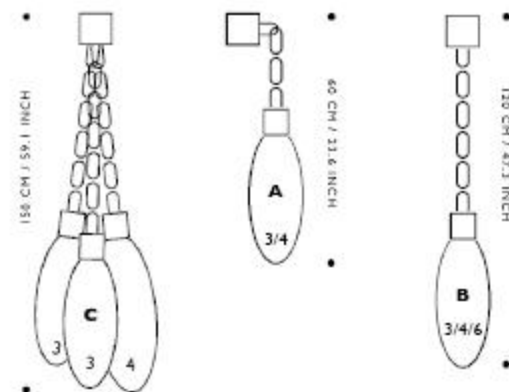
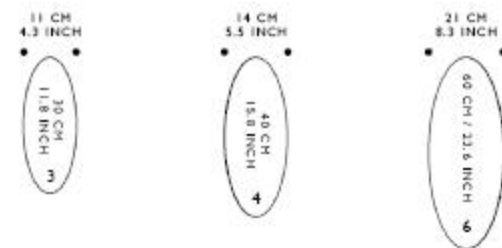



MADISON SQUARE

QUASAR COLLECTION

TAFELLAMP

RVS gepolijst en
hoogglans zwart.
Glas opaline.
Met dimmer.

TISCHLEUCHTE

Edelstahl poliert und
hochglanz schwarz.
Glas Opaline.
Mit Dimmer.

TABLELAMP

Stainless steel polished
and glossy black.
Glass opaline.
With dimmer.

LAMPE DE TABLE

Acier inoxydable poli
et noire brillant.
Verre Opaline.
Avec variateur.

2 X E27 / 60W

DESIGN: RAVAGE

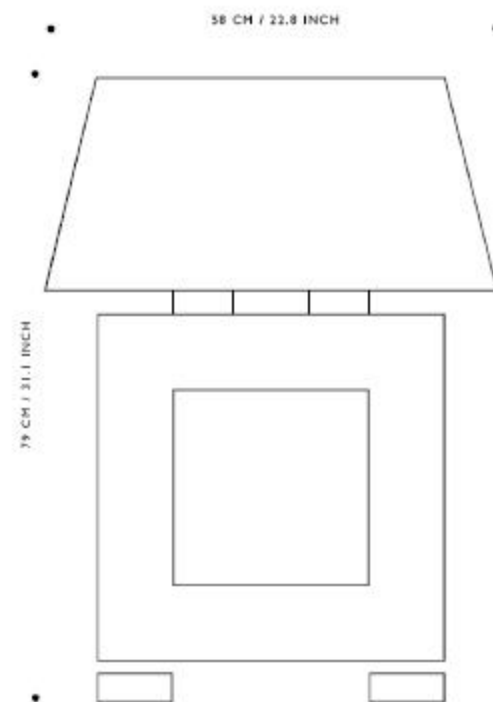



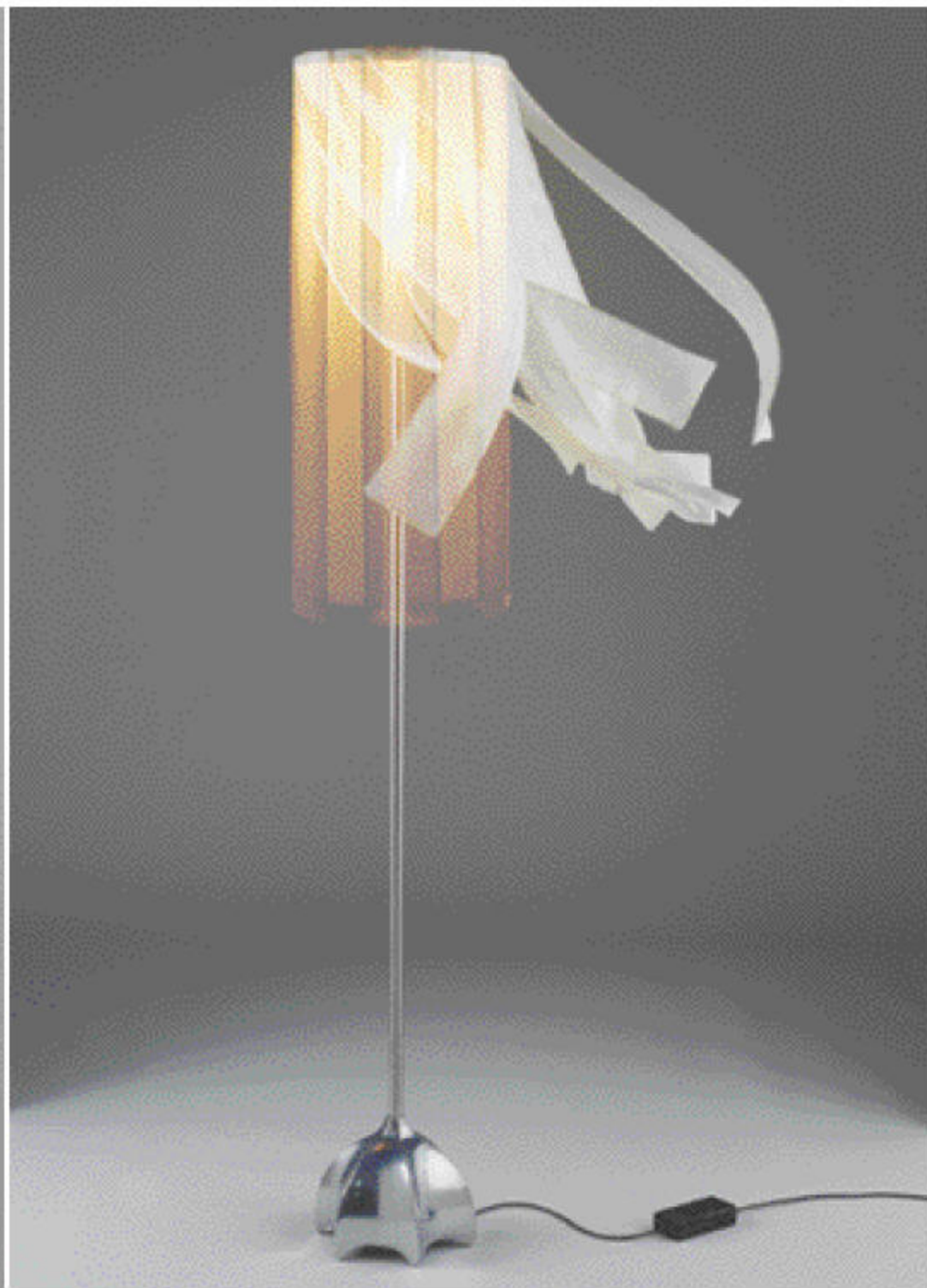

MAXARA

QUASAR COLLECTION

HANGLAMP

Aluminium gesatineerd,
aluminium gepolijst of
ruw brons.
Zijde naturel wit of gekleurd.
Met dimmer.

HÄNGELEUCHTE

Aluminiumguss satiniert,
Aluminium poliert oder
Bronzeguss roh. Seiden
naturweiss oder gefarbt.
Mit Dimmer.

SUSPENDED LAMP

Cast aluminium satin,
aluminium polished or
cast bronze. Silk natural
white or coloured.
With dimmer.

SUSPENSION

Fusion d'aluminium satiné,
aluminium poli ou bronze brut.
Soie naturel blanc ou coloré.
Avec dimmer.

2 X E27 / 75W HALOGEN

DESIGN:
BART CONEN EN IRE VAN DEN BERGH

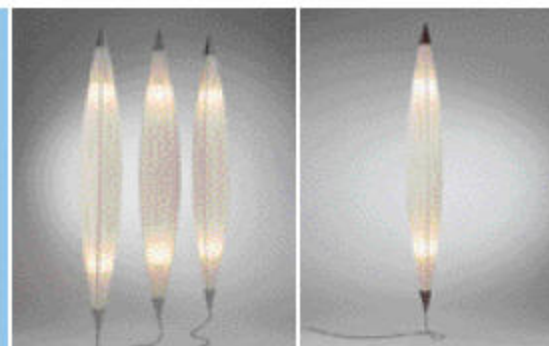

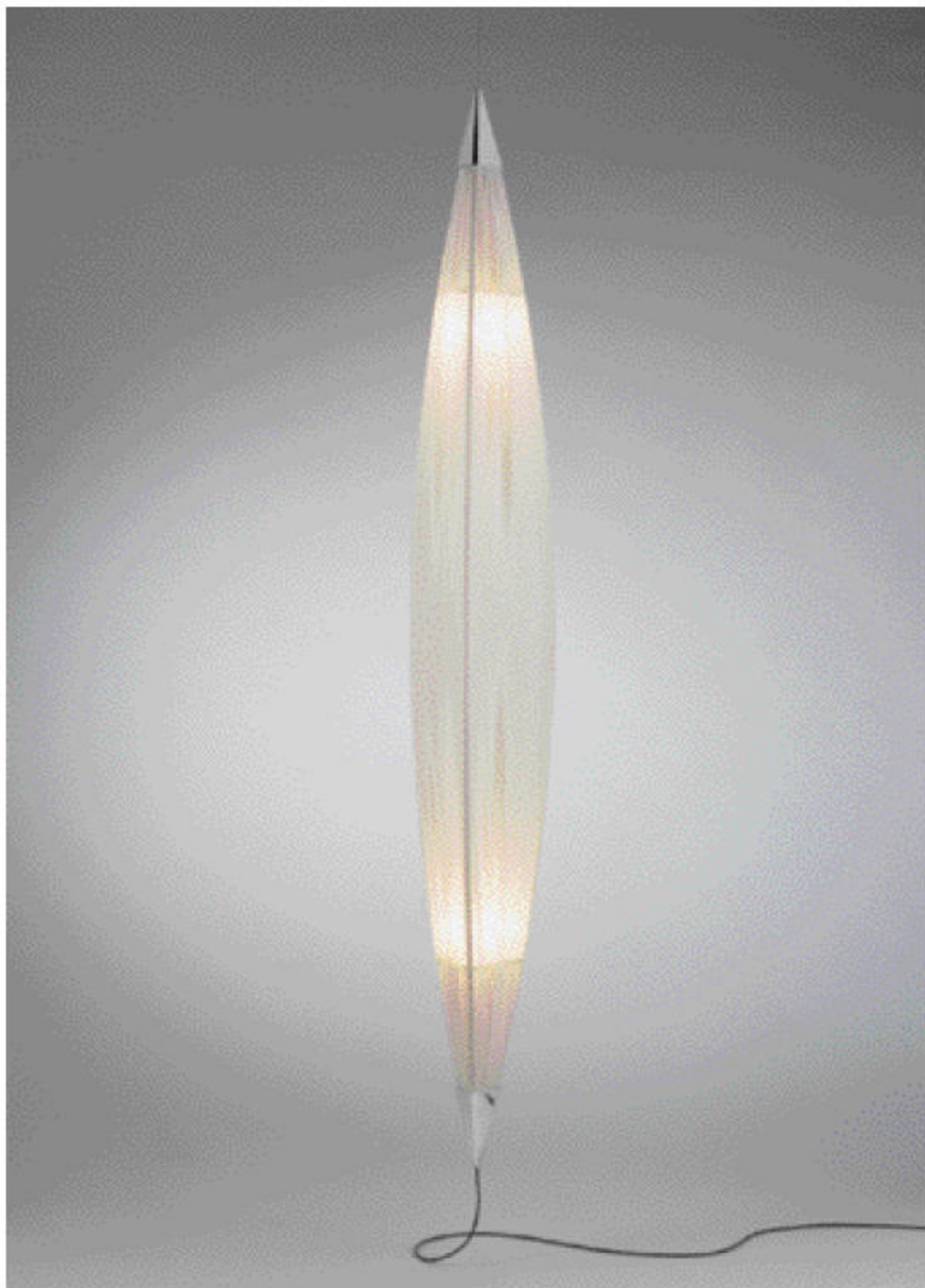

MUJAY

QUASAR COLLECTION

TAFELLAMP

Murano glas en RVS.
Met dimmer.

TISCHLEUCHTE

Murano Glas und Edelstahl.
Mit Dimmer.

TABLELAMP

Murano glass and
stainless steel.
With dimmer.

LAMPE DE TABLE

Verre de Murano et
acier inoxydable.
Avec variateur.

1 X E27 / 75W HALOGEN

DESIGN: EDWARD VAN VLIET

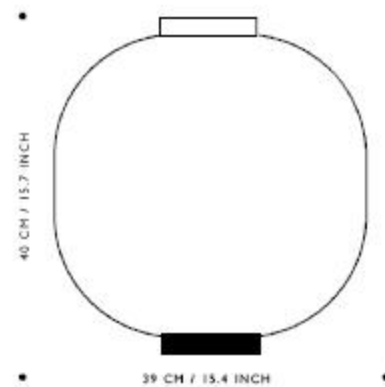





MUJAY

QUASAR COLLECTION

TAFEL- EN VLOERLAMP

Murano glas,
RVS en chroom.
Met dimmer.

TISCH- UND STEHLEUCHTE

Murano Glas,
Edelstahl und Chrom.
Mit Dimmer.

TABLE- AND FLOORLAMP

Murano glass, stainless steel
and chromium.
With dimmer.

LAMPE DE TABLE ET LAMPADAIRE

Verre de Murano,
acier inoxydable et chrome.
Avec variateur.

1 X E27 / 75W HALOGEN

DESIGN: EDWARD VAN VLIET

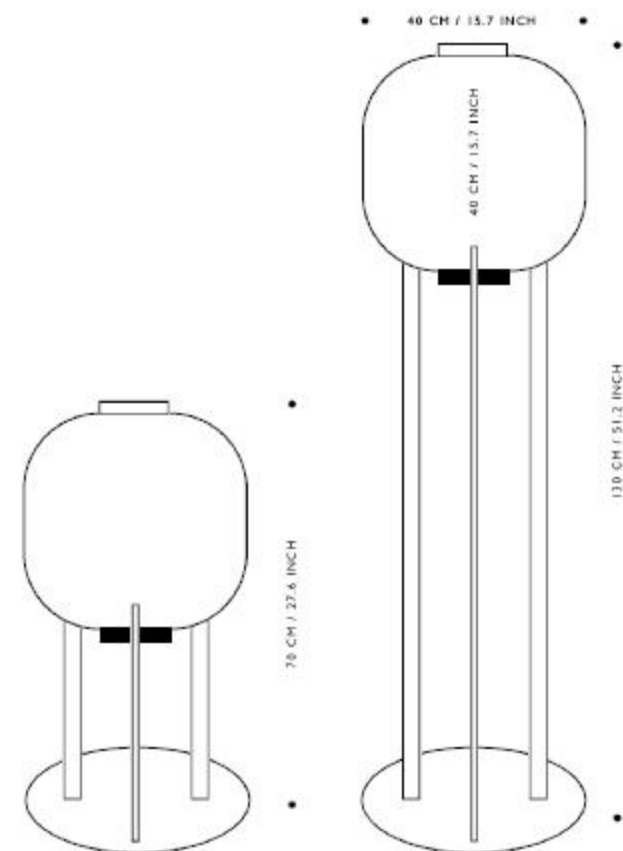



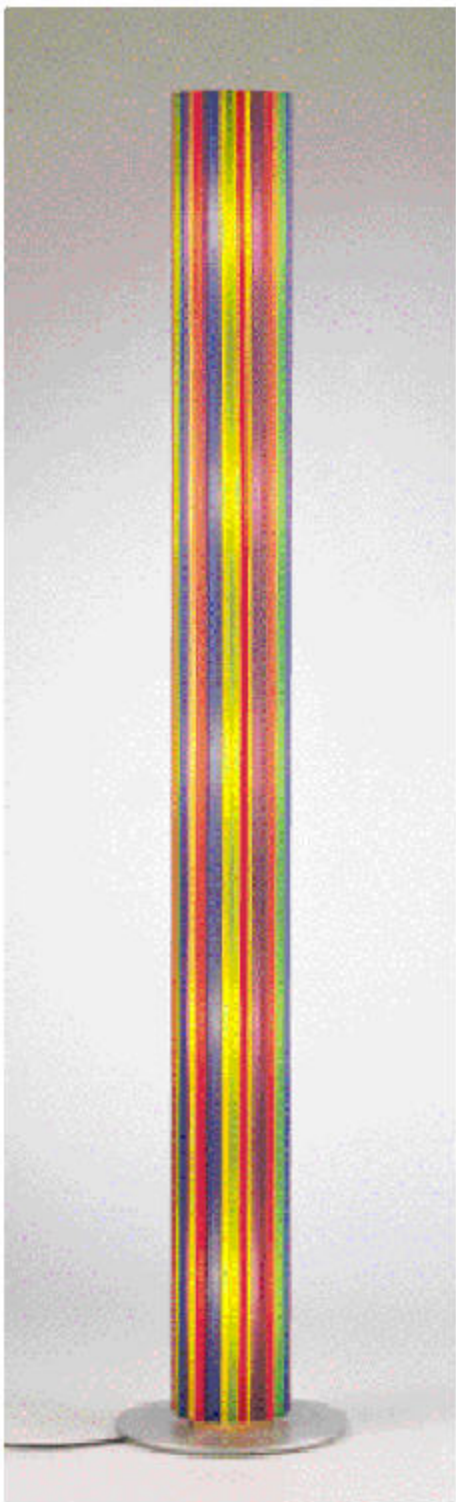

MURANISSIMO

QUASAR COLLECTION

VLOERLAMP

Geanodiseerd aluminium.
Kap met wit of gekleurd
zijdeband bewerkt en gecoat.
Met dimmer.

STEHLEUCHTE

Aluminium eloxiert.
Schirm mit gefarbt oder
weiss Seidenband bearbeitet
und lackiert. Mit Dimmer.

FLOORLAMP

Anodised aluminium.
Coloured or white silk tape
finished shade and lacquered.
With dimmer.

LAMPADAIRE

Aluminium anodisé.
Abat-jour recouvert de soie
naturel blanc ou coloré et
imperméabilisé anti statique.
Avec variateur.

5 x E27 / 60W

DESIGN: PAUL INBRECHTS

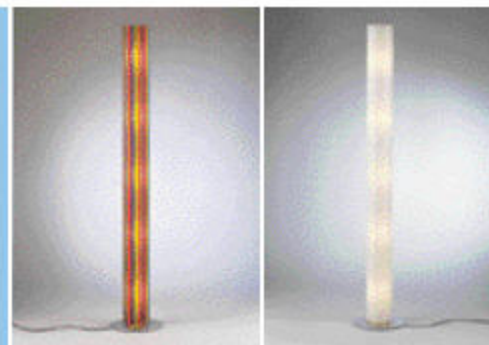

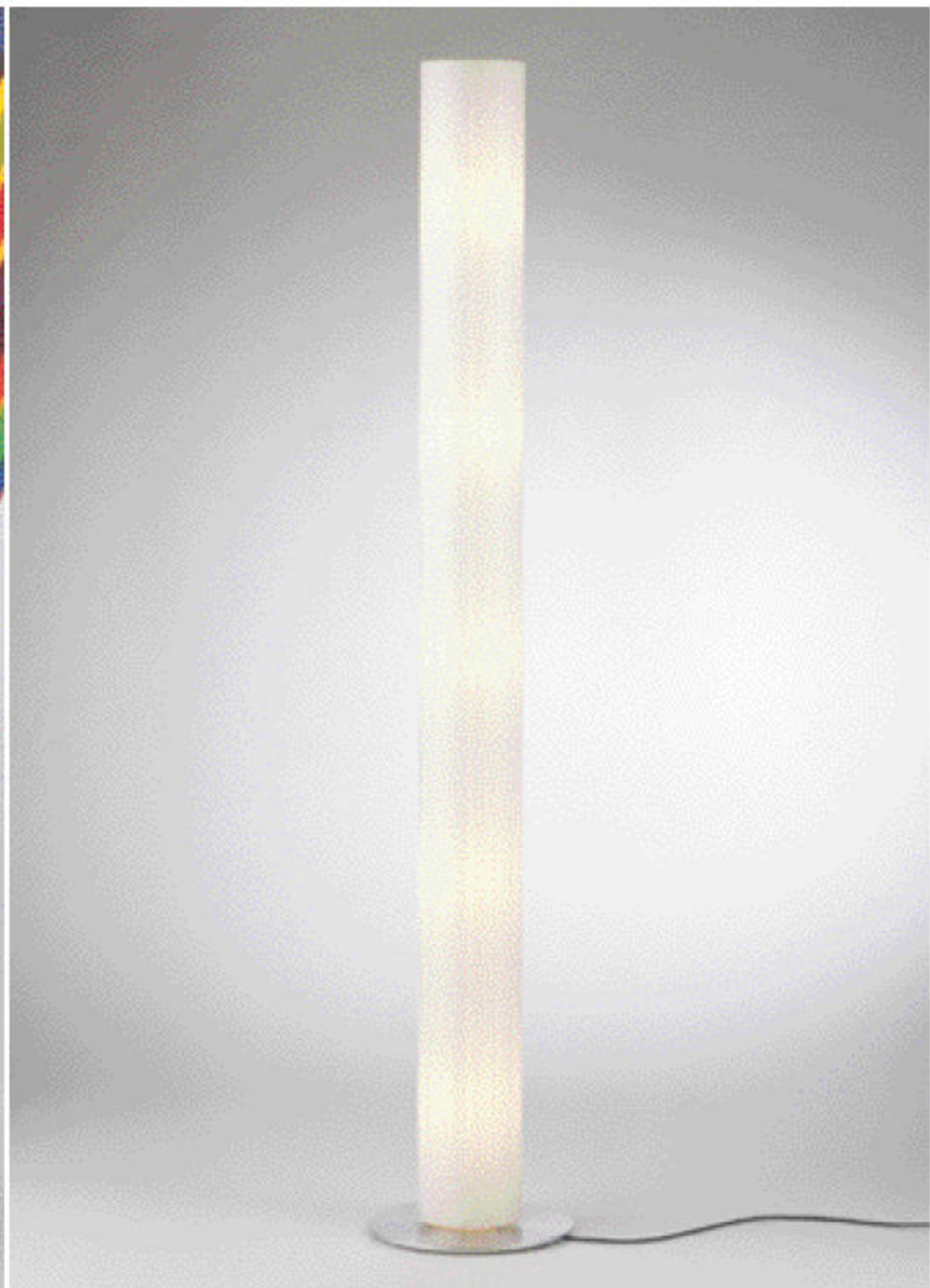
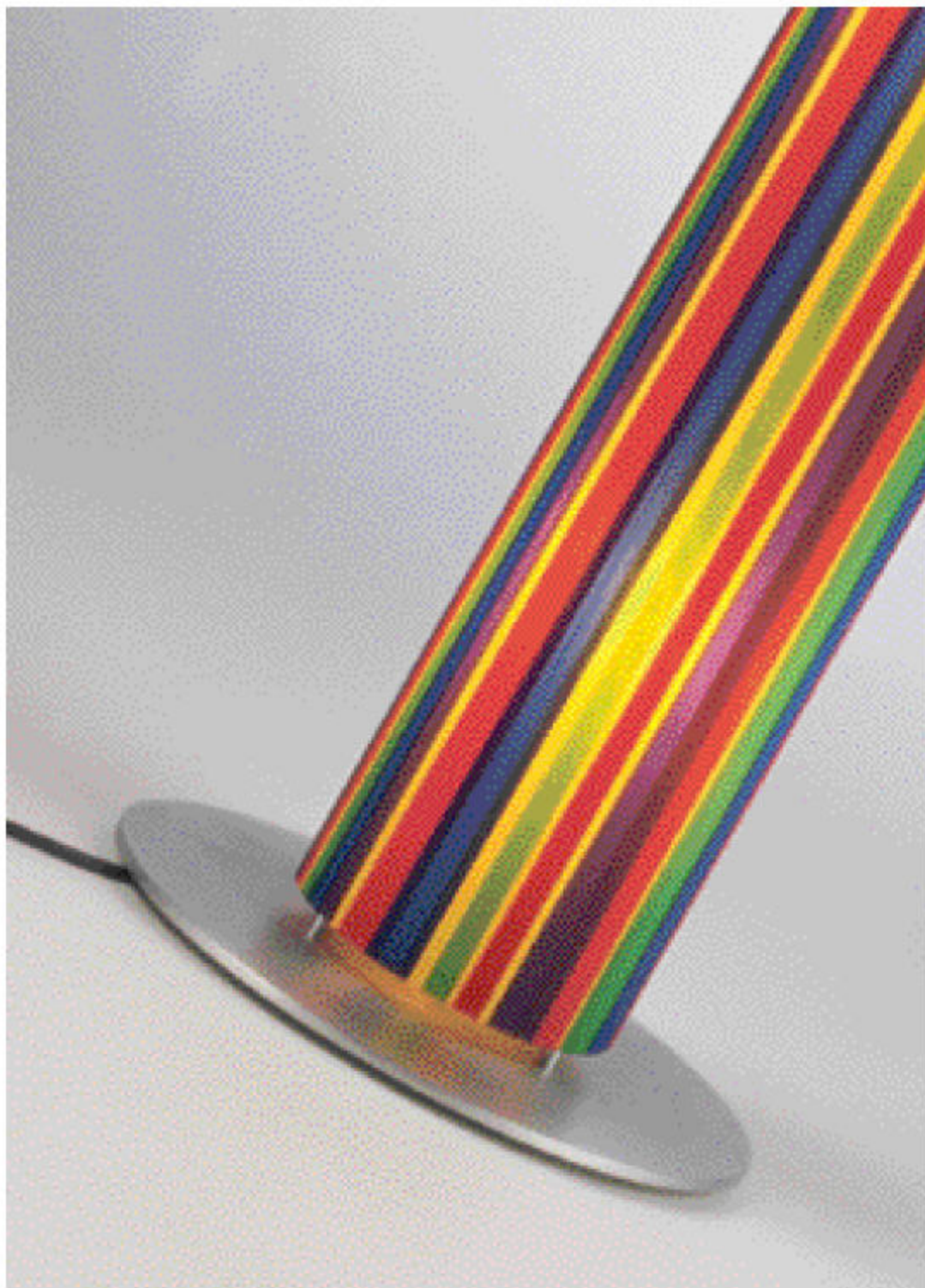

NO. 1

QUASAR COLLECTION

VLOER- EN TAFELLAMP

Aluminium, mahonie,
Frans eiken of wengé.
Kap Liniel gecoat met katoen.
Met dimmer.

STEH- UND TISCHLEUCHTE

Aluminium, Mahagoni,
französisches Eichen oder Wengé.
Schirm Liniel,
überzogen mit Baumwolle.
Mit Dimmer.

FLOOR- AND TABLELAMP

Aluminium, mahogany,
french oak or wengé.
Shade Liniel coated
with cotton.
With dimmer.

**LAMPADAIRE ET
LAMPE DE TABLE**

Aluminium, acajou, Chêne
français ou wengé.
Abat-jour en Liniel avec coton.
Avec variateur.

1 X E27 / 60W

DESIGN: HENK ELENGA

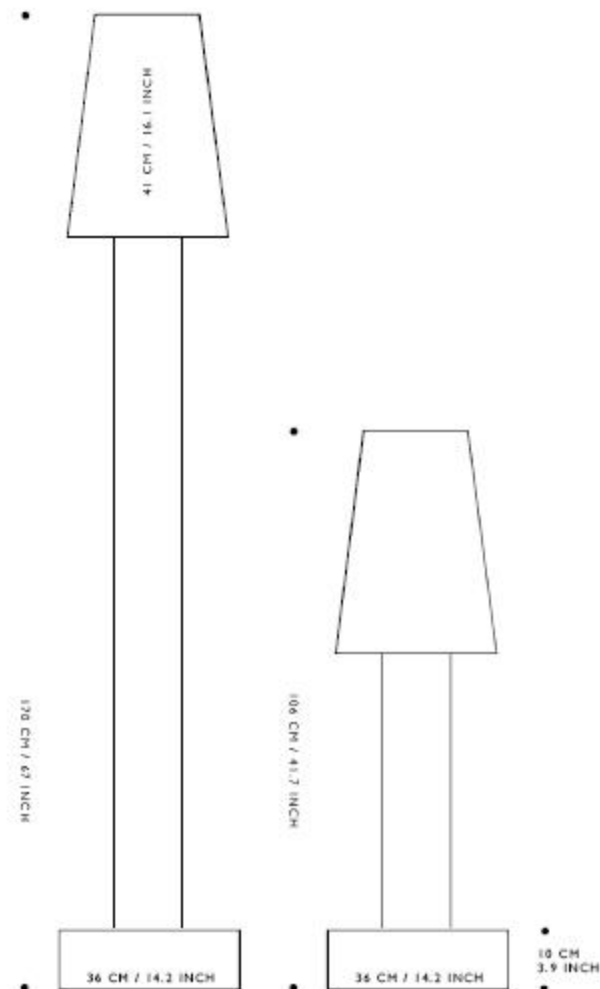



PENN

QUASAR COLLECTION

WANDLAMPRVS gepolijst.
Glas opaline.**WANDLEUCHTE**Edelstahl poliert.
Glas Opaline.**WALL-LAMP**Stainless steel polished.
Glass opaline.**APPLIQUE**Acier inoxydable poli.
Verre opaline.

I X R 75 HALOGEN / 100W / 118MM.

DESIGN: RAVAGE

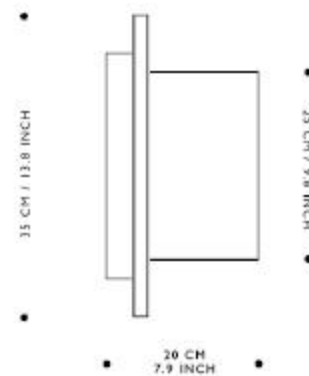
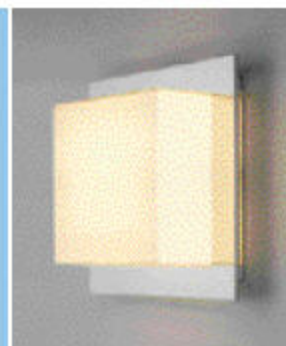



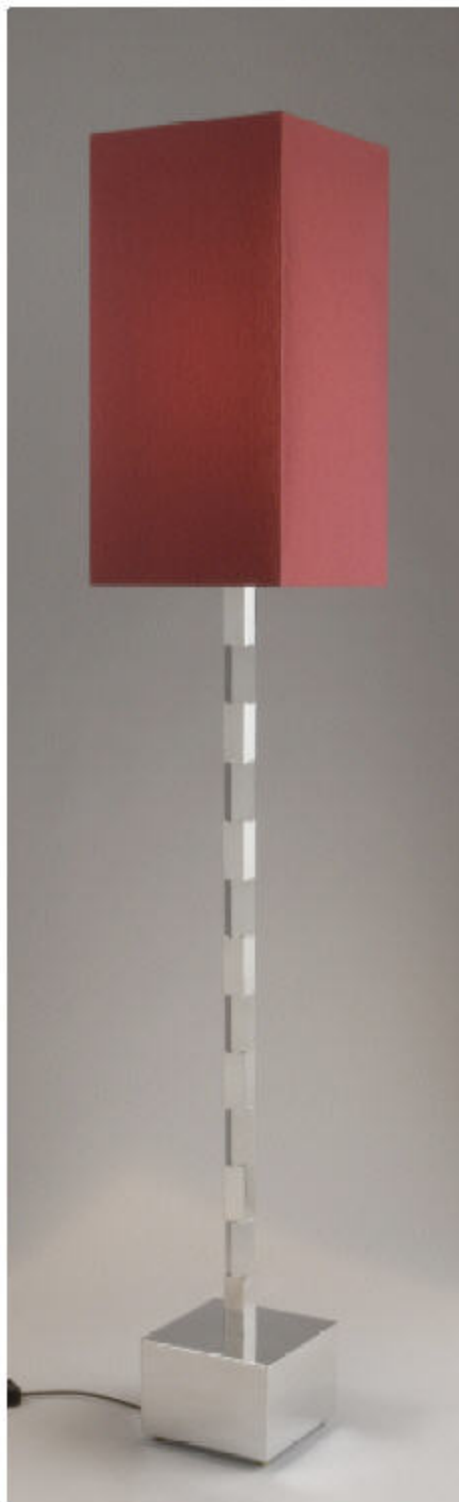

PILE

QUASAR COLLECTION

VLOERLAMP

Aluminium.
Kap met changeant stof
Met dimmer.

STEHLEUCHTE

Aluminium.
Schirm mit Stoff Changeant.
Mit Dimmer.

FLOORLAMP

Aluminium.
Shade with shot fabric.
With dimmer.

LAMPADAIRE

Aluminium.
Abat-jour de tissu changeant.
Avec variateur.

1 X E27 / 200 W

DESIGN: PH



215 CM / 84.6 INCH

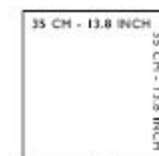
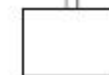

215 CM / 84.6 INCH

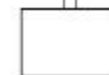



PILE

QUASAR COLLECTION

TAFELLAMP

Aluminium.
Kap met changeant stof
Met dimmer.

TISCHLEUCHTE

Aluminium.
Schirm mit Stoff Changeant.
Mit Dimmer.

TABLELAMP

Aluminium.
Shade with shot fabric.
With dimmer.

LAMPE DE TABLE

Aluminium.
Abat-jour de tissu changeant.
Avec variateur.

I X E27 / 100 W

DESIGN: PH

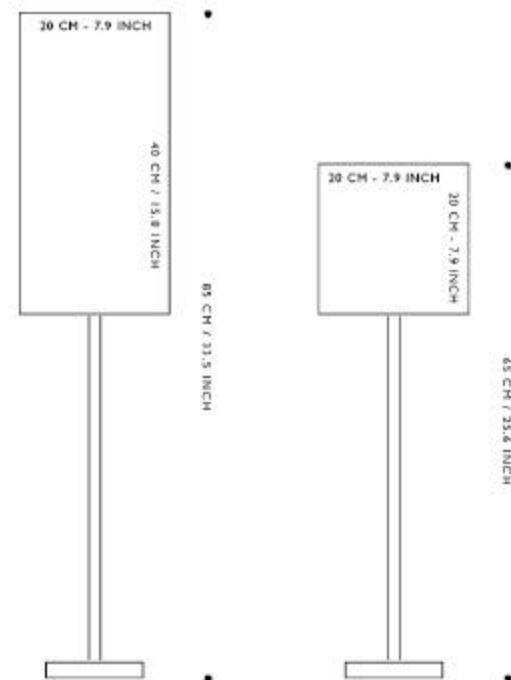



PORTOFINO

QUASAR COLLECTION

HANGLAMP EN PLAFONNIÈRE

Gegoten en gepolijst
aluminium of ruw brons.
Murano glas groen of blauw.

HÄNGE- UND DECKENLEUCHE

Aluminiumguss poliert
oder Bronzeguss roh.
Murano Glas grün oder blau.

SUSPENDED AND CEILINGLAMP

Cast aluminium polished
or cast bronze raw.
Murano glass green or blue.

SUSPENSION ET PLAFONNIER

Fusion d'aluminium poli
ou bronze brute.
Verre de Murano vert ou bleu.

1 X E27 HALOGEN / 100W

DESIGN: JAN DES BOUVRIE

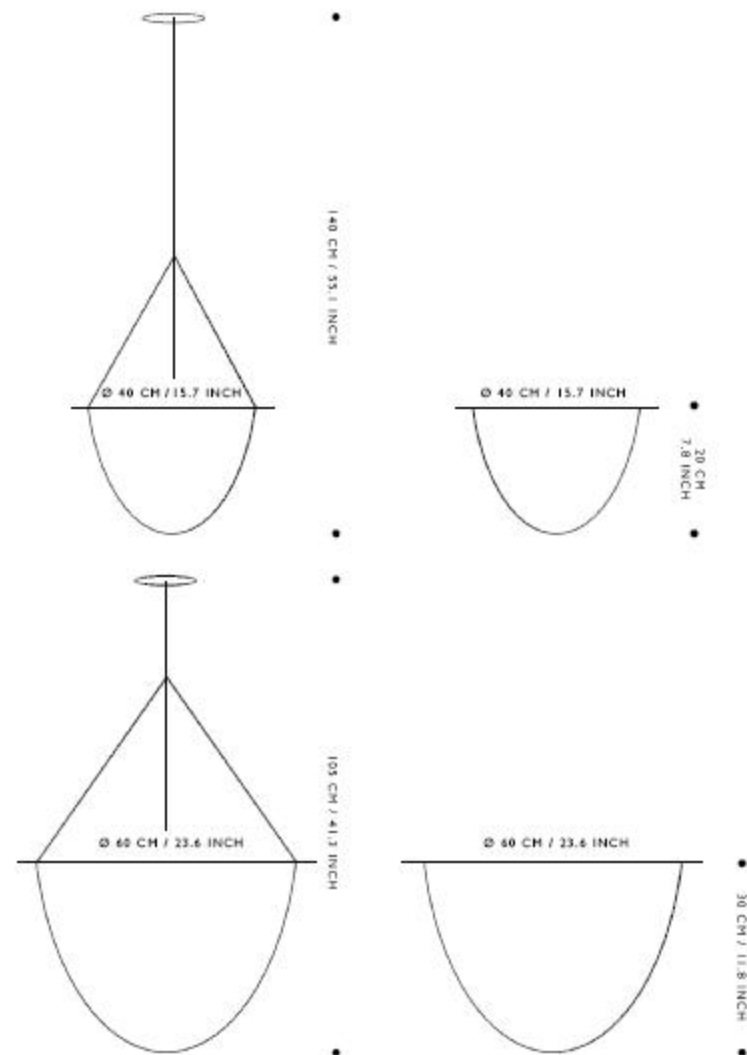



I O S P R I E T

QUASAR COLLECTION

VLOERLAMP

RVS, aluminium en Muranoglas.
Met dimmer.

STEHLEUCHTE

Edelstahl, Aluminium und
Muranoglas.
Mit Dimmer.

FLOORLAMP

Stainless steel, aluminium
and Muranoglass.
With dimmer.

LAMPADAIRE

Acier inoxydable, aluminium
et verre de Murano.
Avec variateur.

10 X B15D / 15W

DESIGN: ROB NOLLET

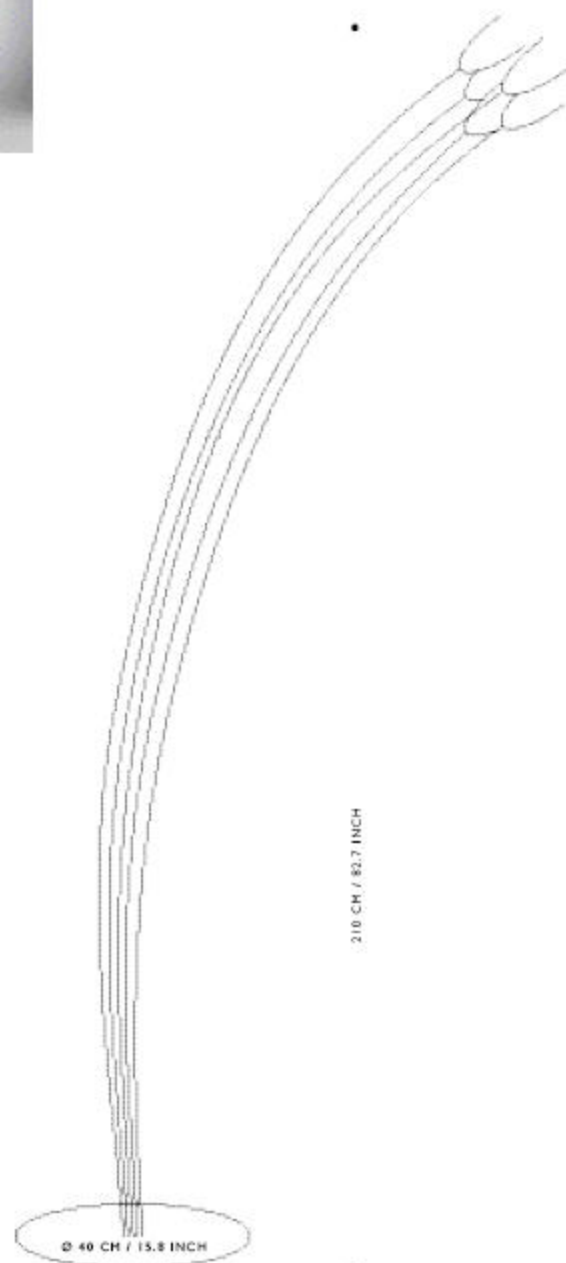

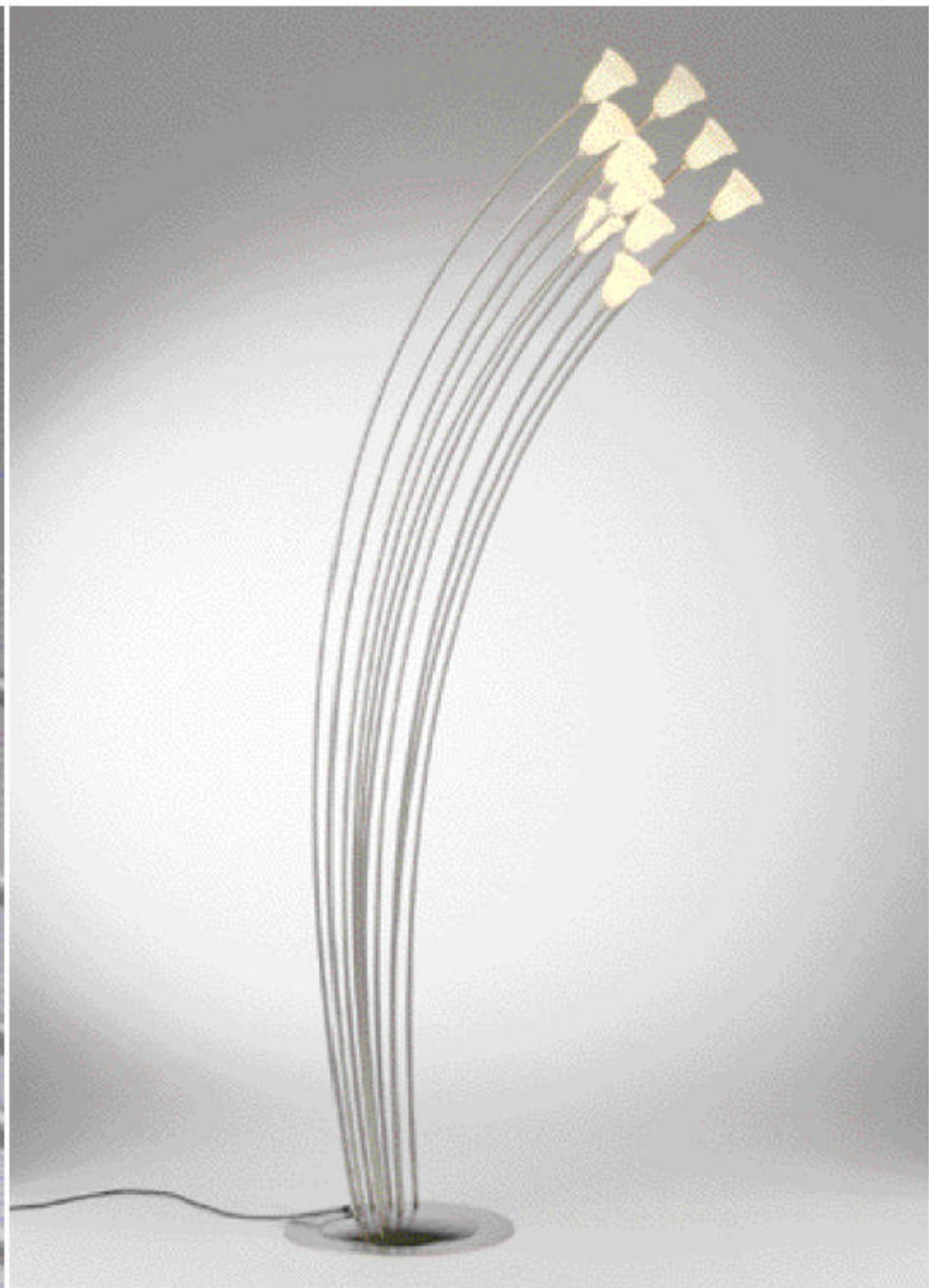
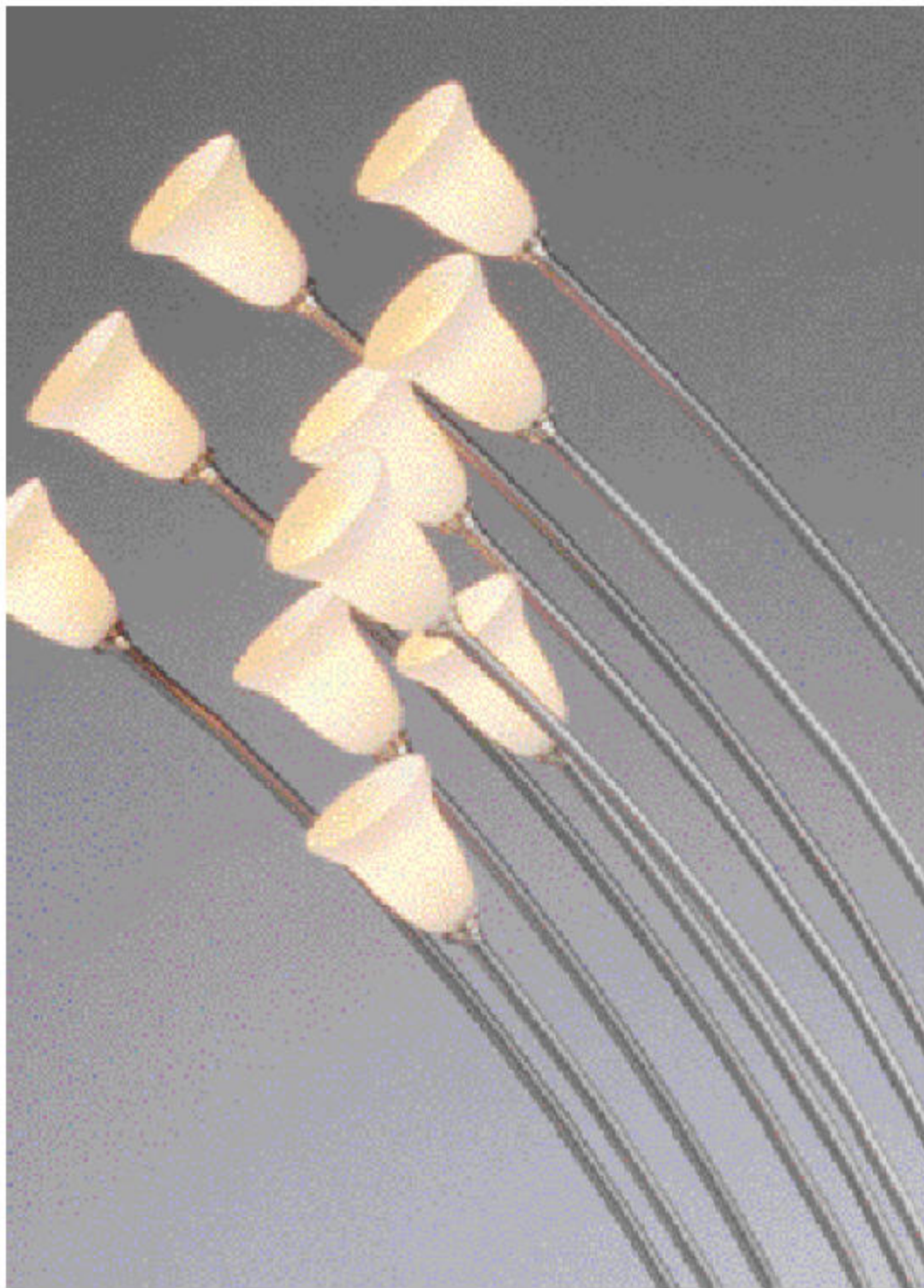

TOSCANA

QUASAR COLLECTION

WANDLAMP
Gegoten en gepolijst
aluminium of raw brons.

WANDLEUCHTE
Aluminiumguss poliert
oder Bronzeguss roh.

WALL-LAMP
Cast aluminium polished
or cast bronze raw.

APPLIQUE
Fusion d'aluminium poli
ou bronze brute.

I X E27 / 75W HALOGEN

DESIGN: MIES & VAN GESSSEL

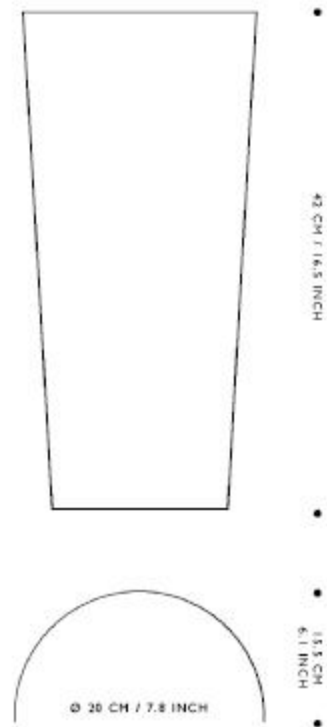
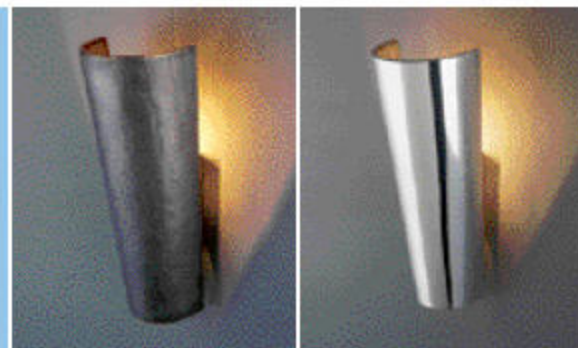

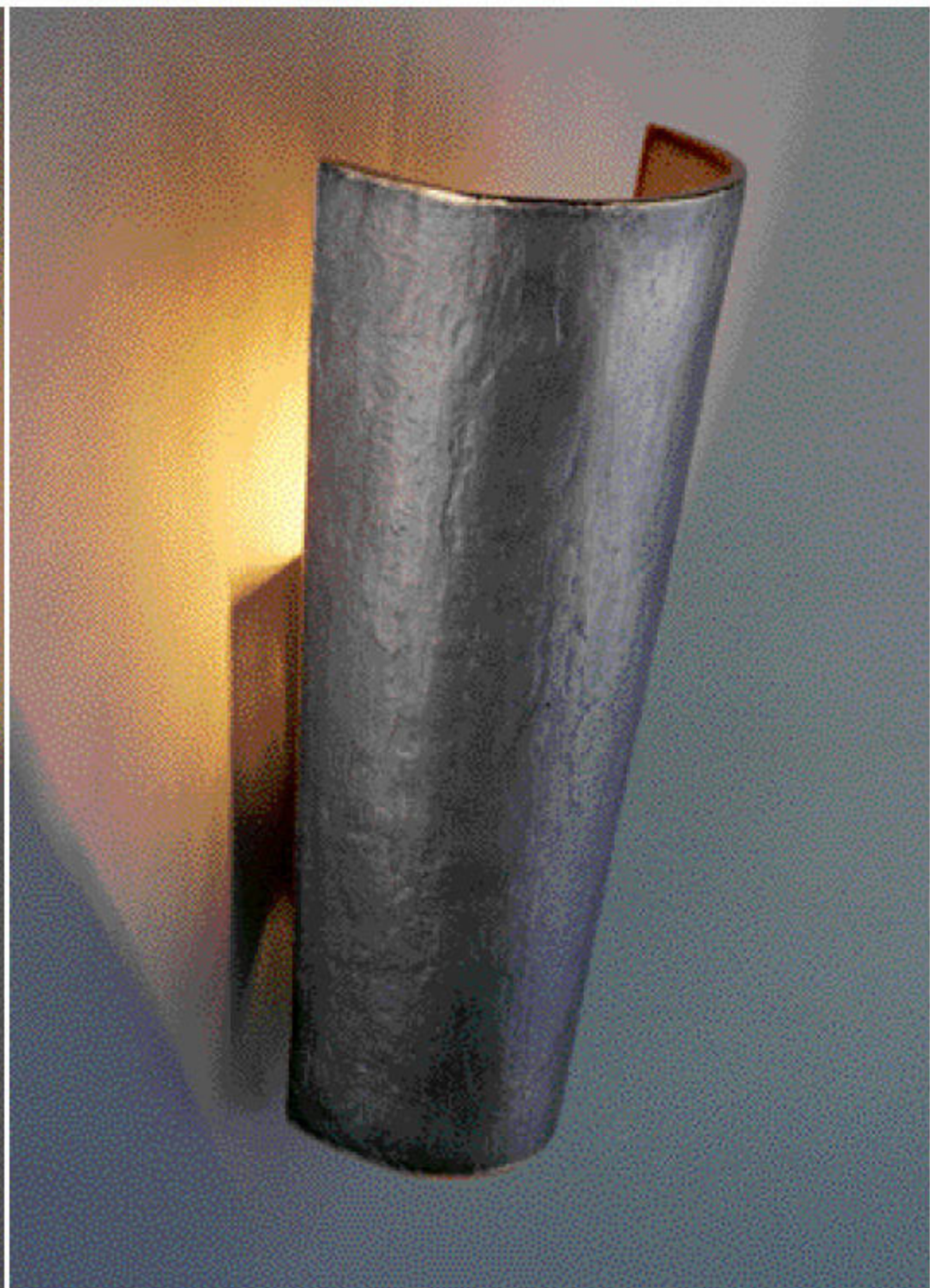

WAVE

QUASAR COLLECTION

TAFELLAMP

Gegoten en gepolijst
aluminium of raw brons.
Met dimmer.

TISCHLEUCHTE

Aluminiumguss poliert oder
Bronzeguss roh.
Mit Dimmer.

TABELLAMP

Cast aluminium polished
or cast bronze raw.
With dimmer.

LAMPE DE TABLE

Fusion d'aluminium poli
ou bronze brute.
Avec variateur.

1 X E27 / 75W HALOGEN

DESIGN: MIES & VAN GESSSEL

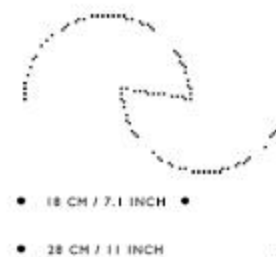
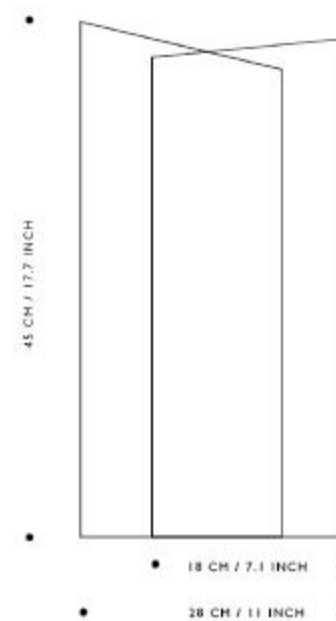
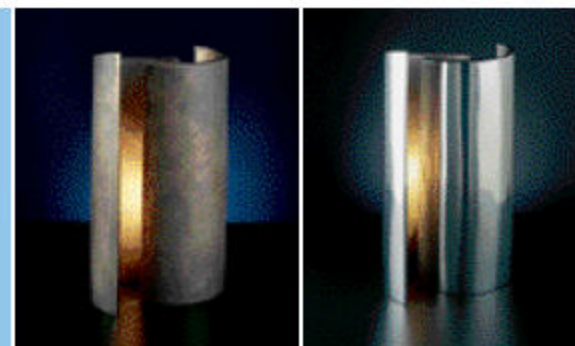

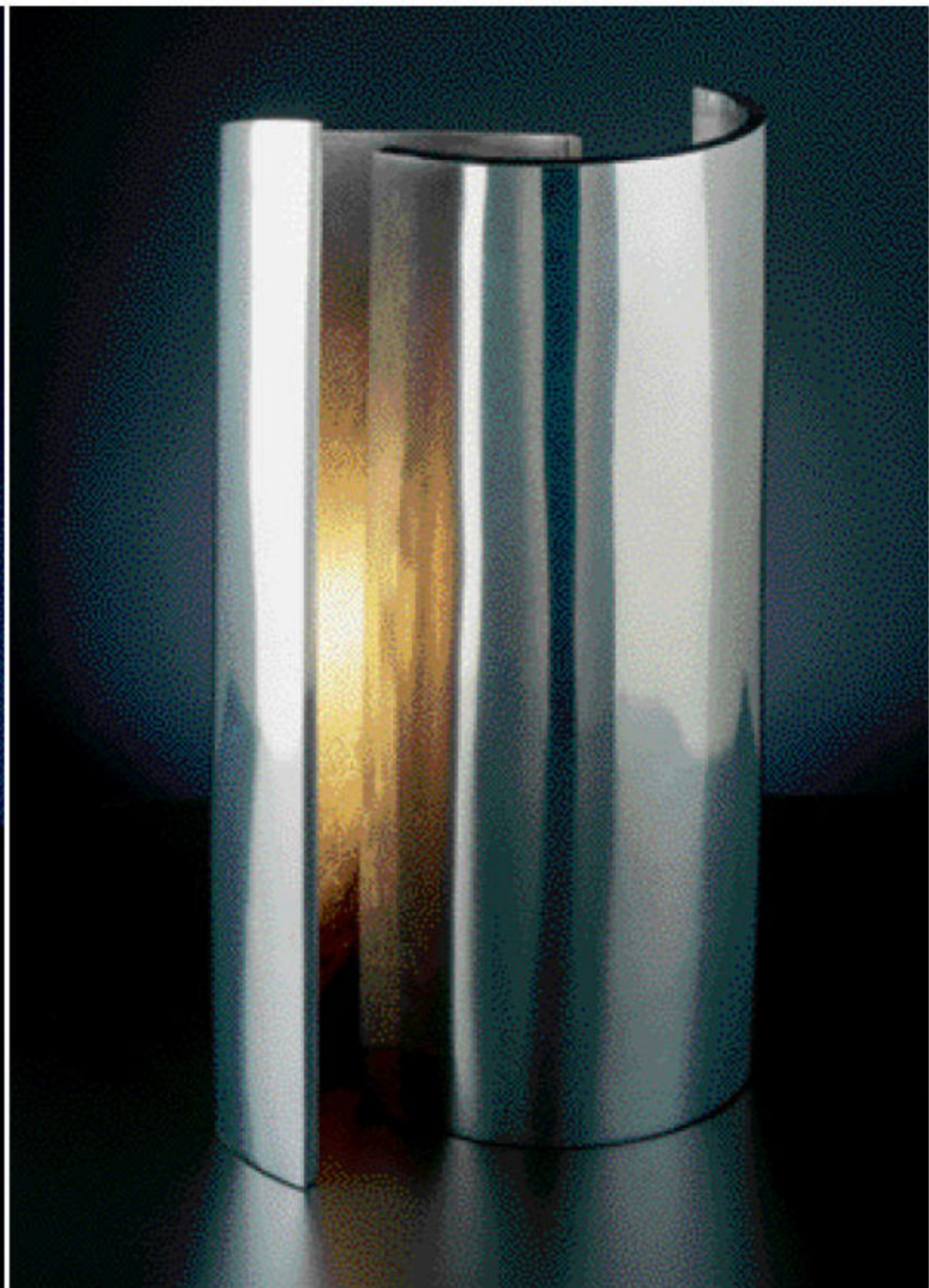
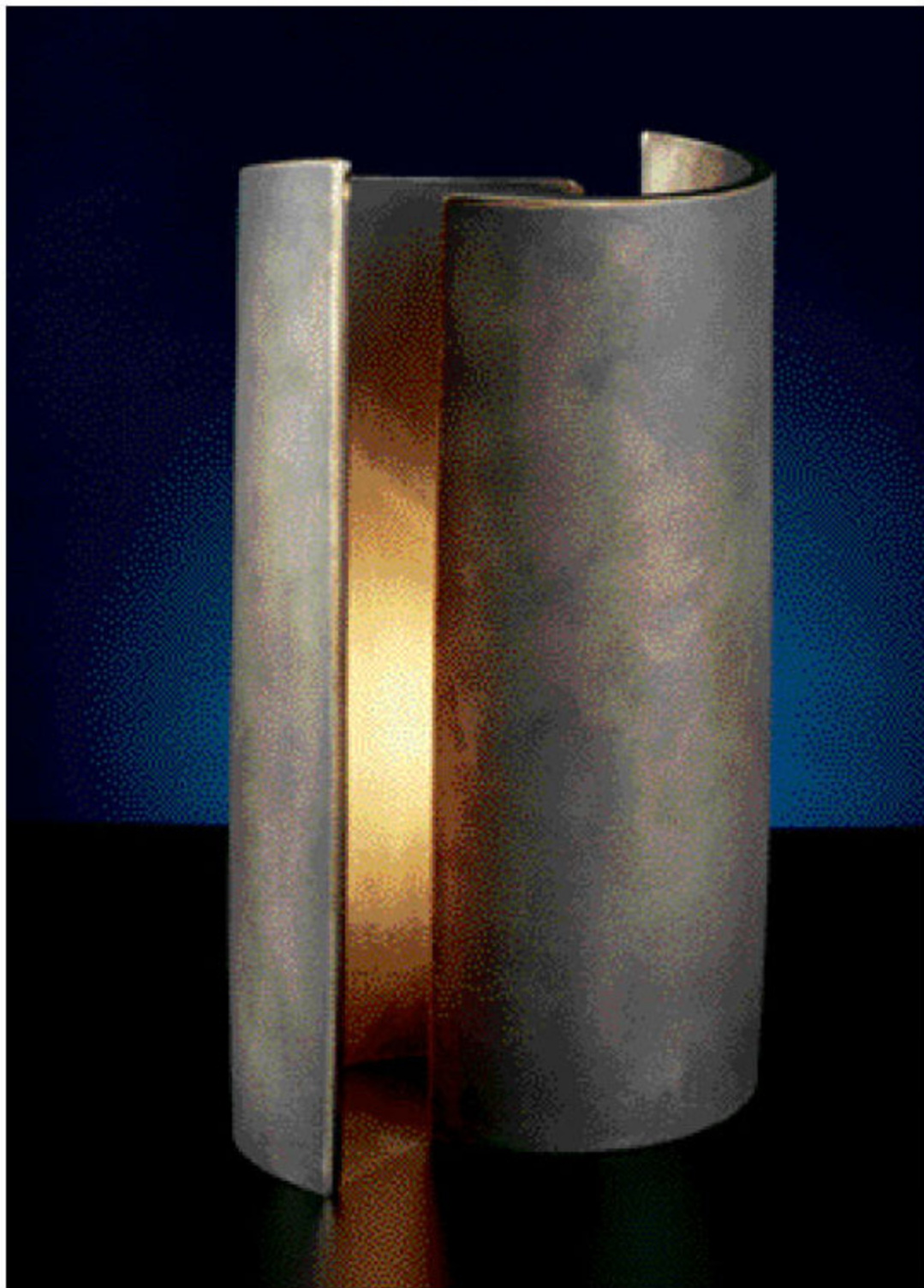

WINGS

QUASAR COLLECTION

HANGLAMP

Gegoten en gepolijst
aluminium of ruw brons.
In 3 lengtes.

HÄNGELEUCHTE

Aluminiumguss poliert
oder Bronzeguss roh.
In 3 Längen.

SUSPENDED LAMP

Cast aluminium polished
or cast bronze raw.
In 3 lengths.

SUSPENSION

Fusion d'aluminium poli
ou bronze brute.
En 3 tailles.

20 CM / 1 X G6,35 HALOGEN / 50W

33 CM / 2 X G6,35 HALOGEN / 35W

44 CM / 3 X G6,35 HALOGEN / 35W

DESIGN: FRANS VAN BERKEL

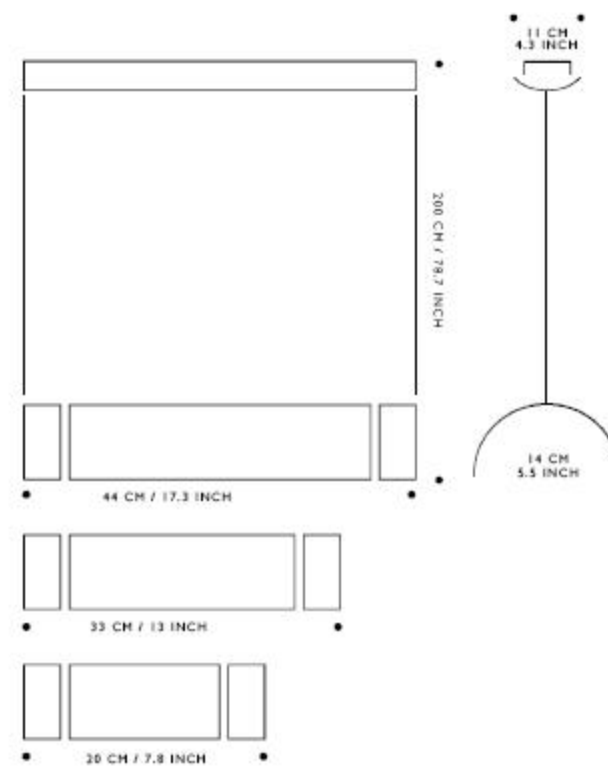
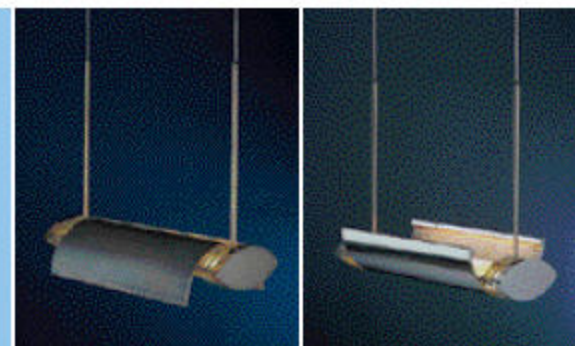

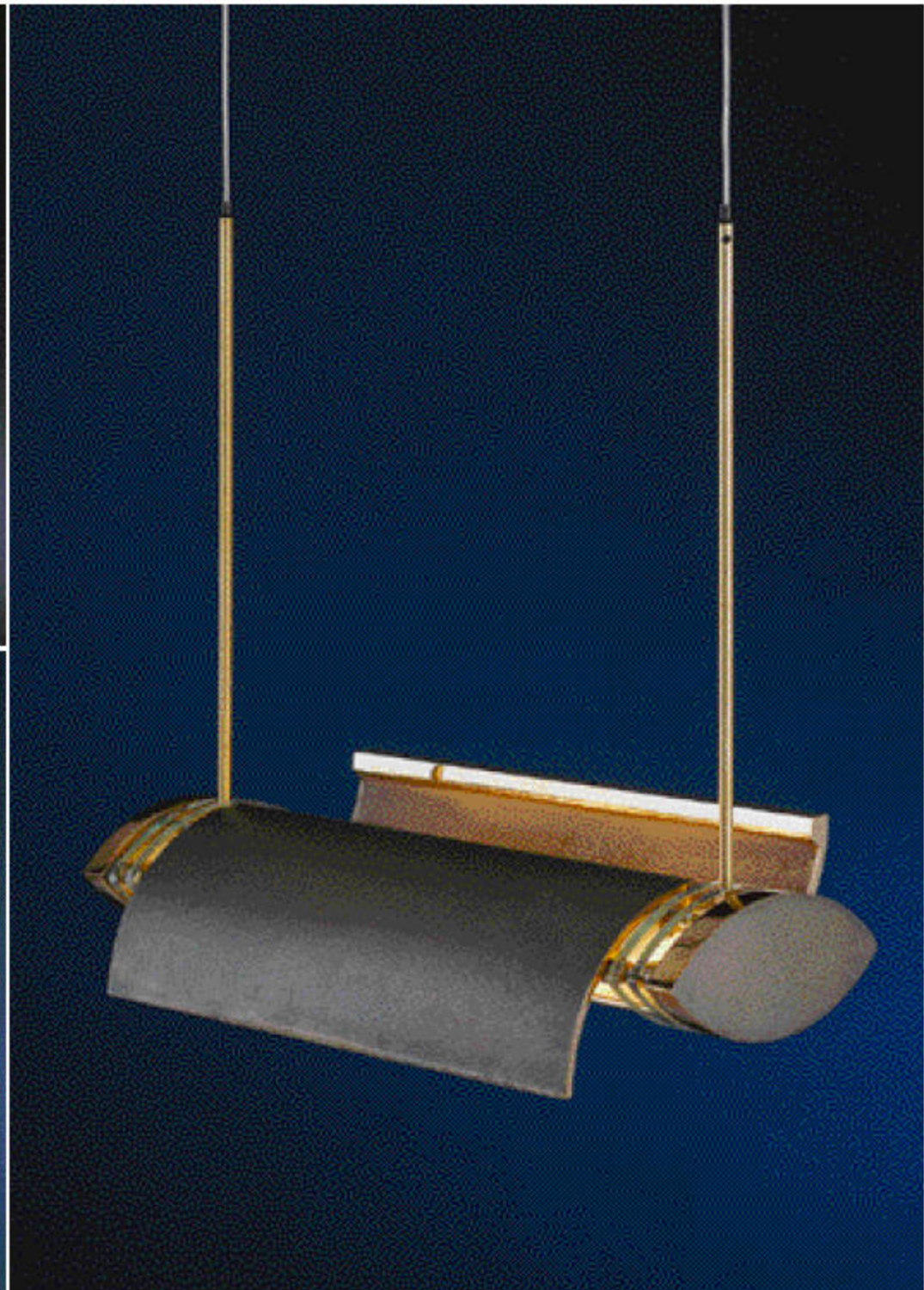
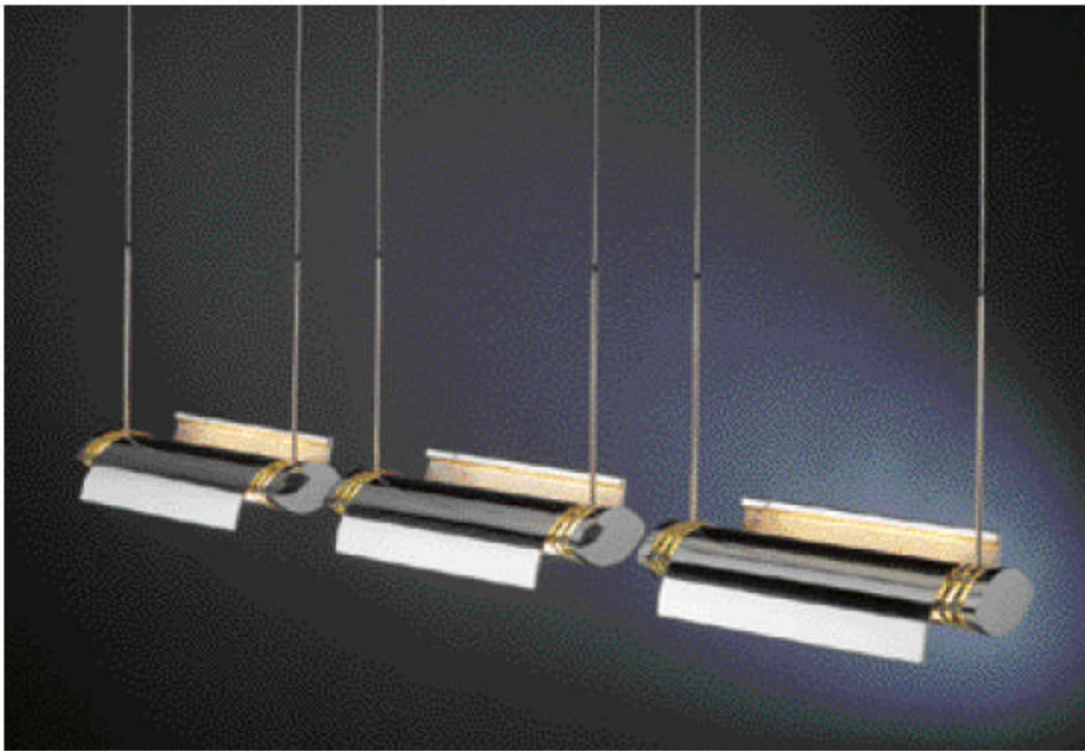

...KANN ES AUCH SCHMALLER?...KANN ES AUCH BREITER?...KANN ES AUCH GRÖßER?...KANN ES AUCH KLEINER?...KANN ES AUCH IN SILBER?...GOLD?...AUCH AUS EDELSTAHL?...BRONZE?...MESSING?...KANN ES AUCH AN EINEN DRAHT HÄNGEN?...KANN ES AUCH GEBRACHT WERDEN?...UND GEHOLT?...KANN ES AUCH IN ANDEREN FARBEN?...ROT?...MACHT IHR DIESES SCHON LANGE?...DENKT IHR DIES ALLES SELBER AUS?...KANN MAN ES EINSCHALTEN?...KANN MAN ES AUSSCHALTEN?...

J A !

Q U A S I Q U A S A R

C O L L E C T I O N



FUTURE JOY CONCEPT EXPERIMENT FORTUNE TELLING

ZUKUNFT FREUDE KONZEPT VERSUCH WAHRSAGUNG

FUTUR JOYEUX CONCEPT UELEXPÉRIENCE PRÉVENIR L'AVENIR

TOEKOMST BLIJ CONCEPT EXPERIMENT WAARZEGGEN







BELIGHT

QUASIQUEASAR COLLECTION

VLOER- EN HANGLAMP
Karton en geanodiseerd
aluminium.
Vloerlamp met dimmer.

STEH- UND HÄNGELEUCHTE
Pappe und Aluminium eloxiert.
Stehleuchte mit Dimmer.

FLOOR- AND SUSPENDED LAMP
Cardboard and anodised
aluminium.
Floorlamp with dimmer.

LAMPADAIRE ET SUSPENSION
Carton et aluminium anodisé.
Lampadaire avec variateur.

1X E27 / 40 W

DESIGN: FREDERIK VAN HEERVELD

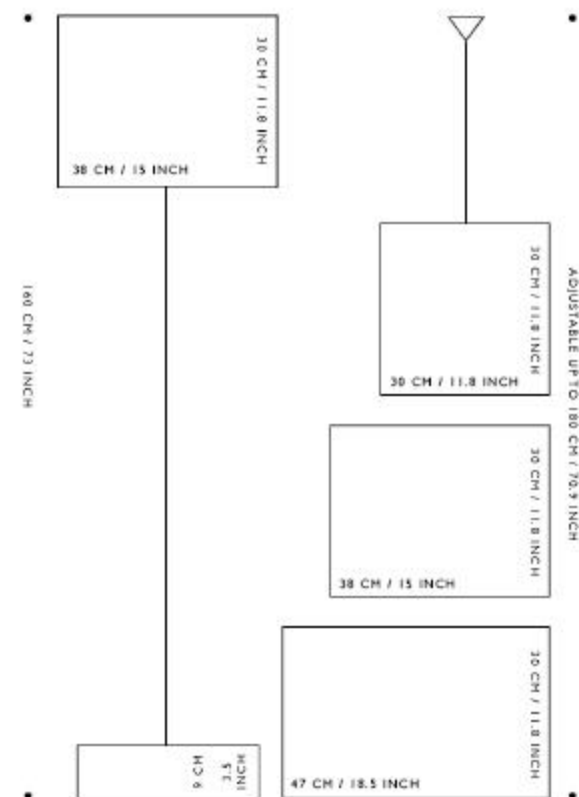



BOBBIN LACE

QUASIQUASAR COLLECTION

BOBBIN LACE

HANGLAMP
Gekantklost glasvezel.

HÄNGELEUCHE
Geklöppelt Glasfiber.

SUSPENDED LAMP
Bobbin laced glass fibre

SUSPENSION
Fibre de verre croché.

1 X GZ 6.35 HALOGEN / 100 W / 12V

DESIGN: MIELS VAN EJK

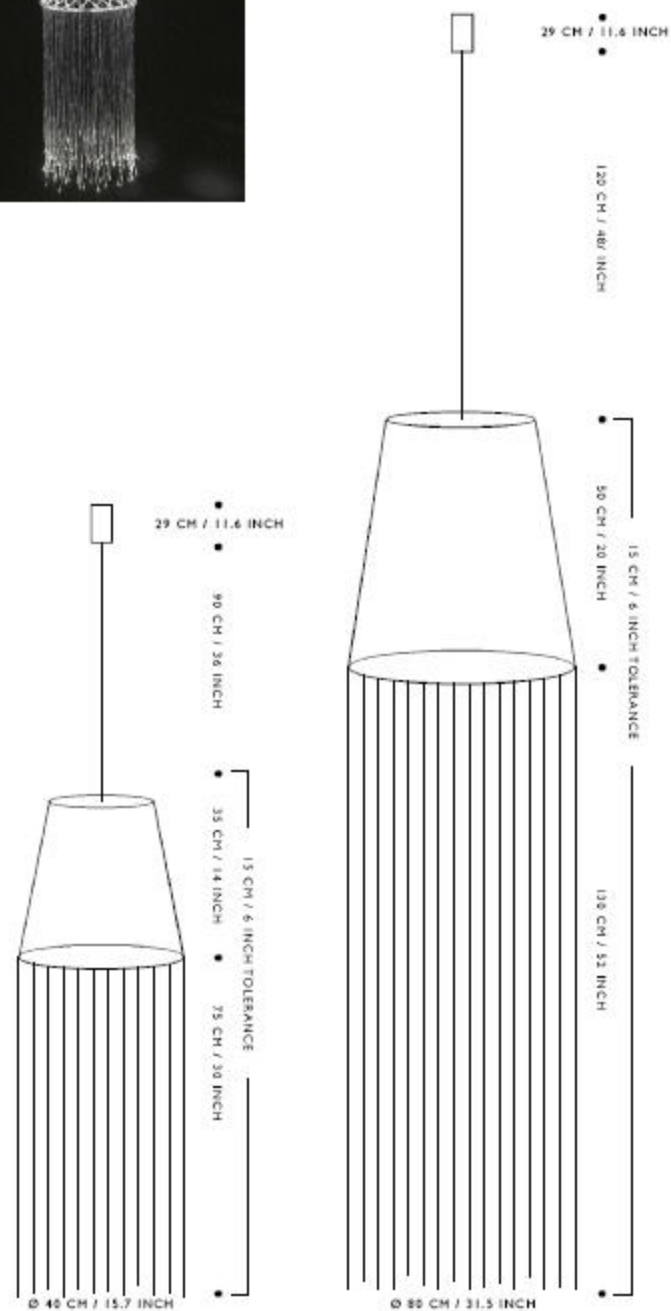



DOCCIA

QUASIQVASAR COLLECTION

HANGLAMP

Aluminium en glas.

HÄNGELEUCHTE

Aluminium und Glas.

SUSPENSION

Aluminium and glass.

SUSPENSION

Aluminium et verre Murano.

4 X G6,35 HALOGEN / 50W / 12V

DESIGN: JOSE HULLER

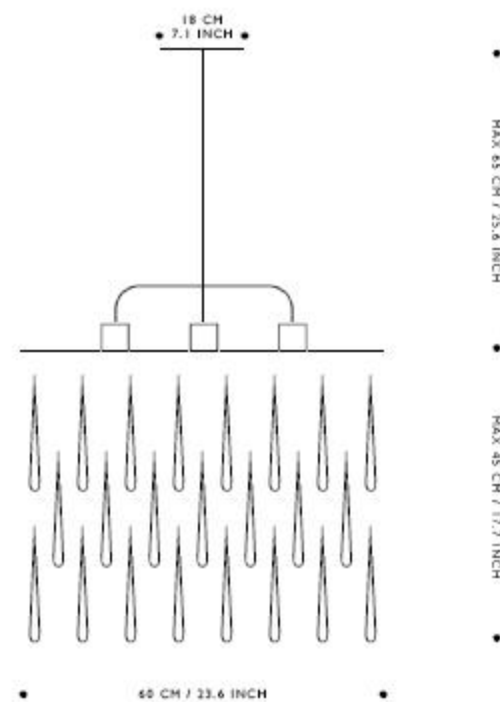



DOCCIA

QUASIQUASAR COLLECTION

HANG- EN WANDLAMP

Aluminium en glas.

HÄNGE- UND WANDELEUCHE

Aluminium und Glas.

SUSPENSION AND WALL-LAMP

Aluminium and glass.

SUSPENSION ET APPLIQUE

Aluminium et verre Murano.

1 X GU10 HALOGEN / 50W / 230V

DESIGN: JOY HULLER

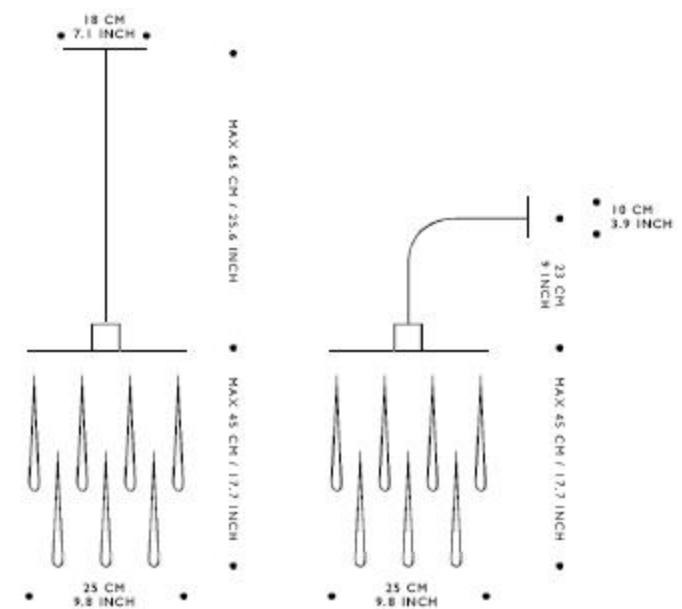



FLIGHT

QUASIQUASAR COLLECTION

HANGLAMP

Frame met Lycra overtrek.
Met dimmer.

HÄNGELUCHTE

Gestell mit Lycra überzogen.
Mit Dimmer.

SUSPENDED LAMP

Frame covered with Lycra.
With dimmer.

SUSPENSION

Corps recouvert de LYCRA.
Avec variateur.

1 X T3 / 34W

DESIGN: MARC DE GROOT

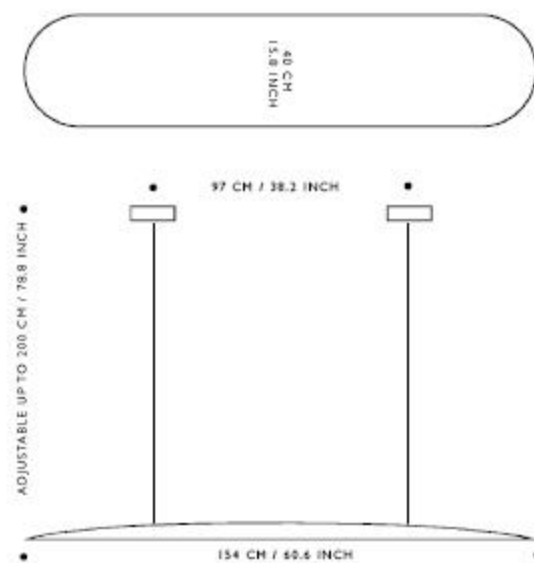

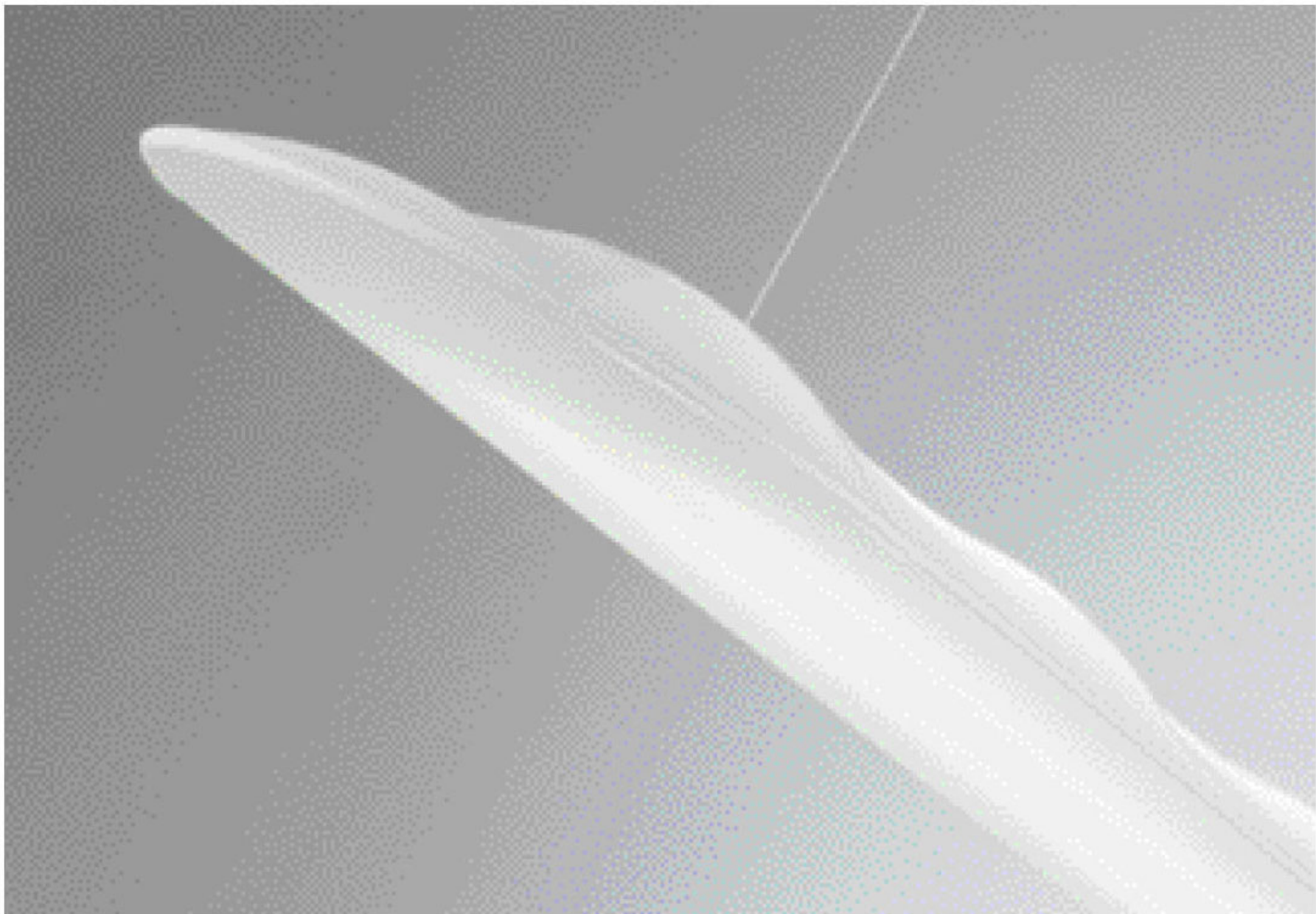

HYPPODROME

QUASIQUASAR COLLECTION

HANGLAMP
Geanodiseerd aluminium.

HÄNGELEUCHTE
Aluminium eloxiert.

SUSPENDED LAMP
Anodised aluminium.

SUSPENSION
Aluminium anodisé.

3 X KRISTALLINE / 120W ONLY 230V

DESIGN: JAK FROWELS

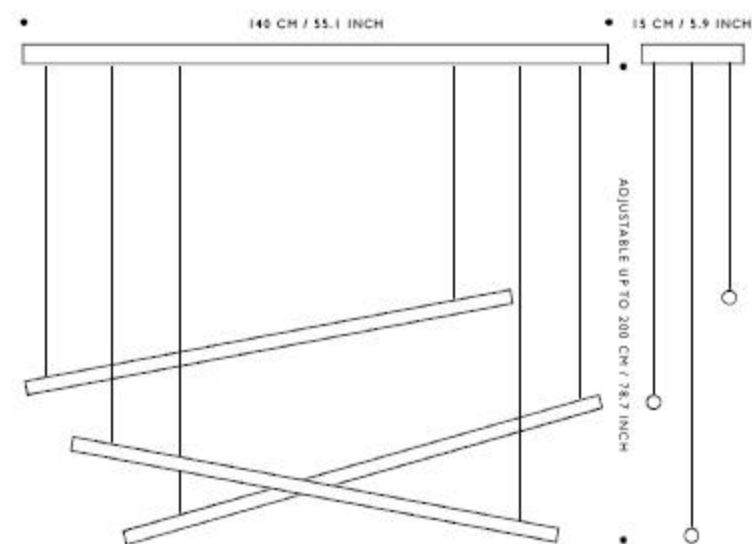
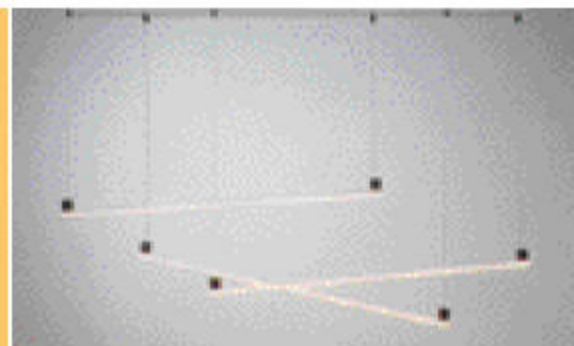

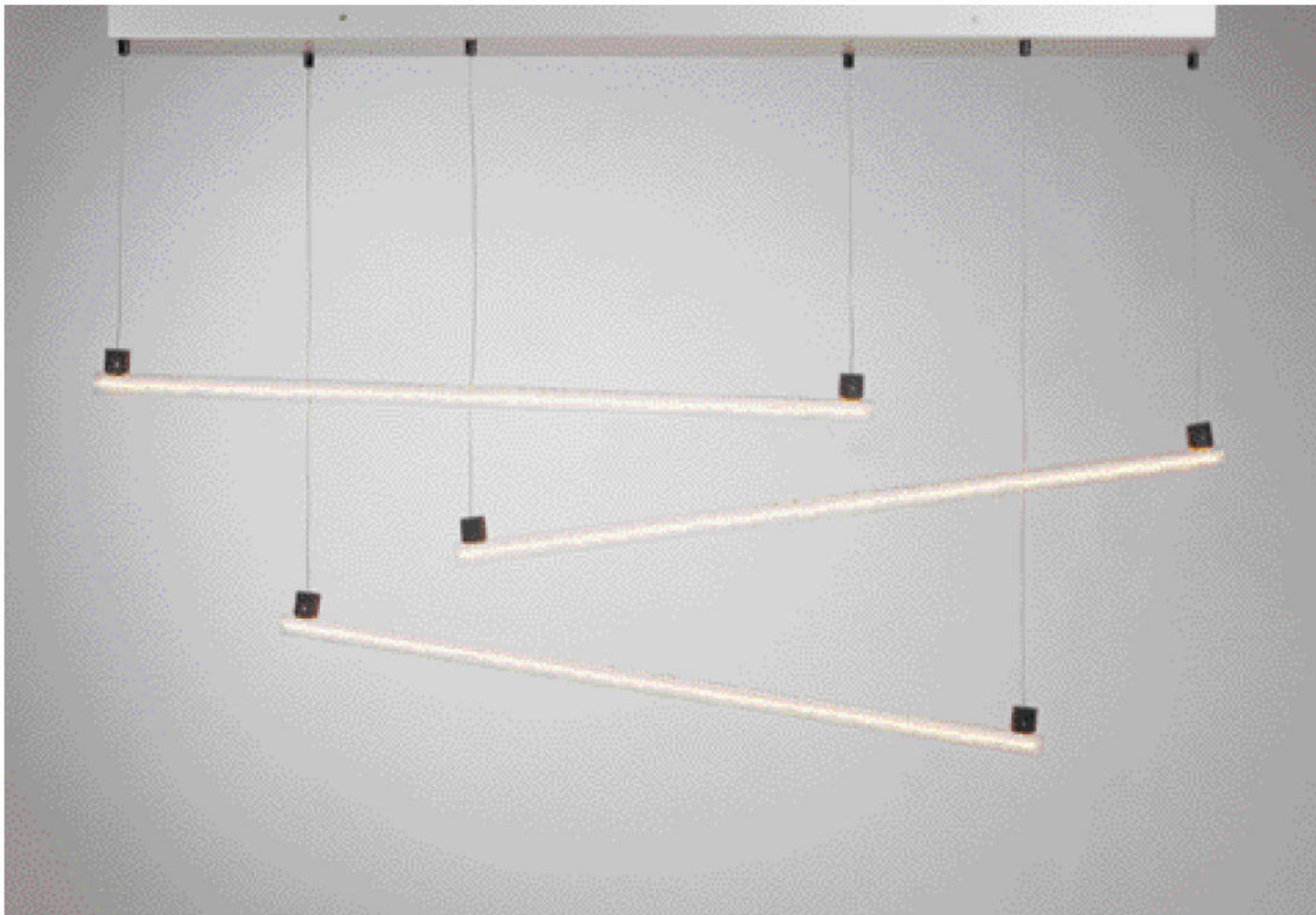

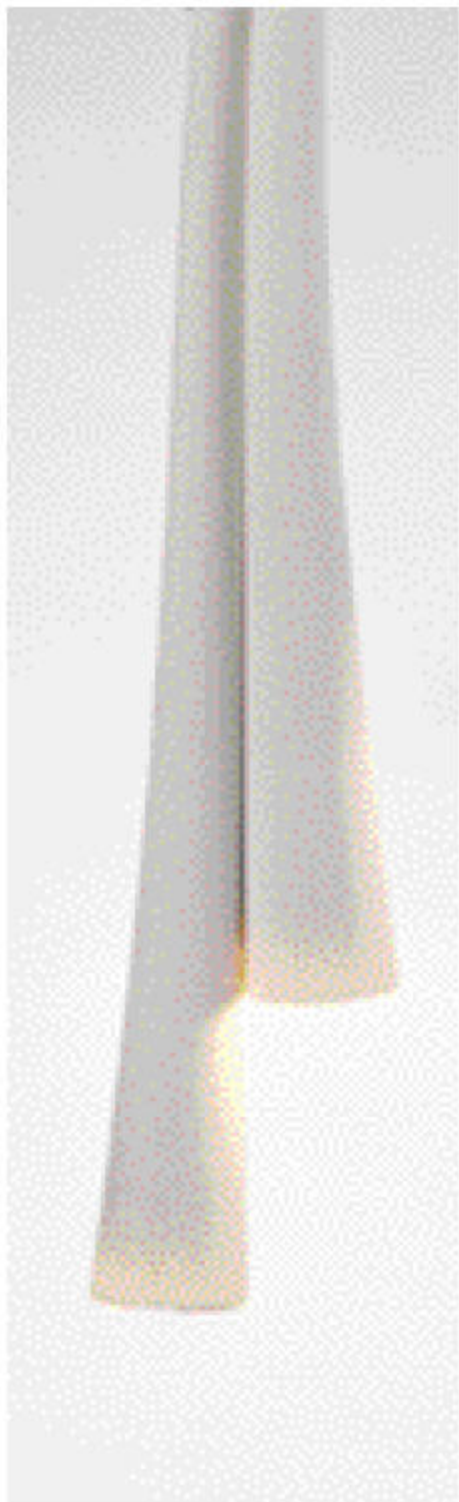

THE LINE

QUASIQUASAR COLLECTION

HANGLAMP
Siliconenrubber.
Metaaldelen
wit gepoedercoat.

HÄNGELEUCHTE
Silicongummi.
Metallteilen weiss
pulverbeschichtet.

SUSPENDED LAMP
Silicone rubber.
Metal parts white
powder coated.

SUSPENSION
Caoutchouc silicone.
Pieces métallique
blanc anodisé.

1 x E14 / 10W
or 1 x GU4 HALOGEN / 20 W

DESIGN: MARKO SCHREGARDUS

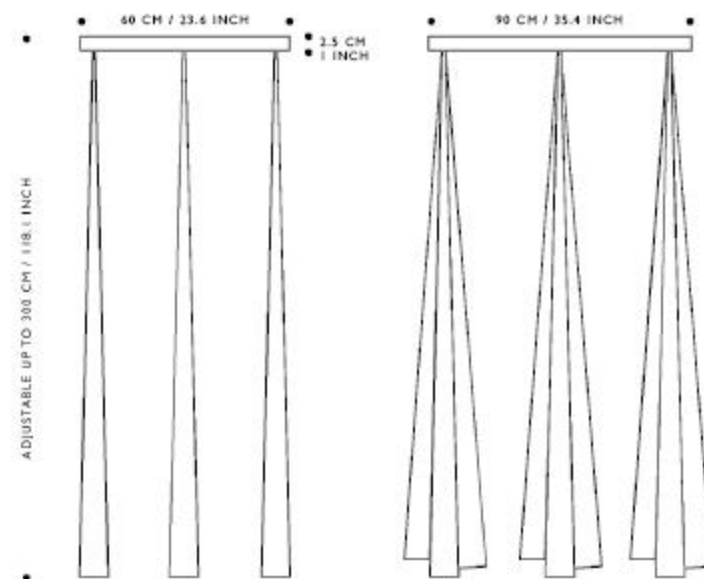

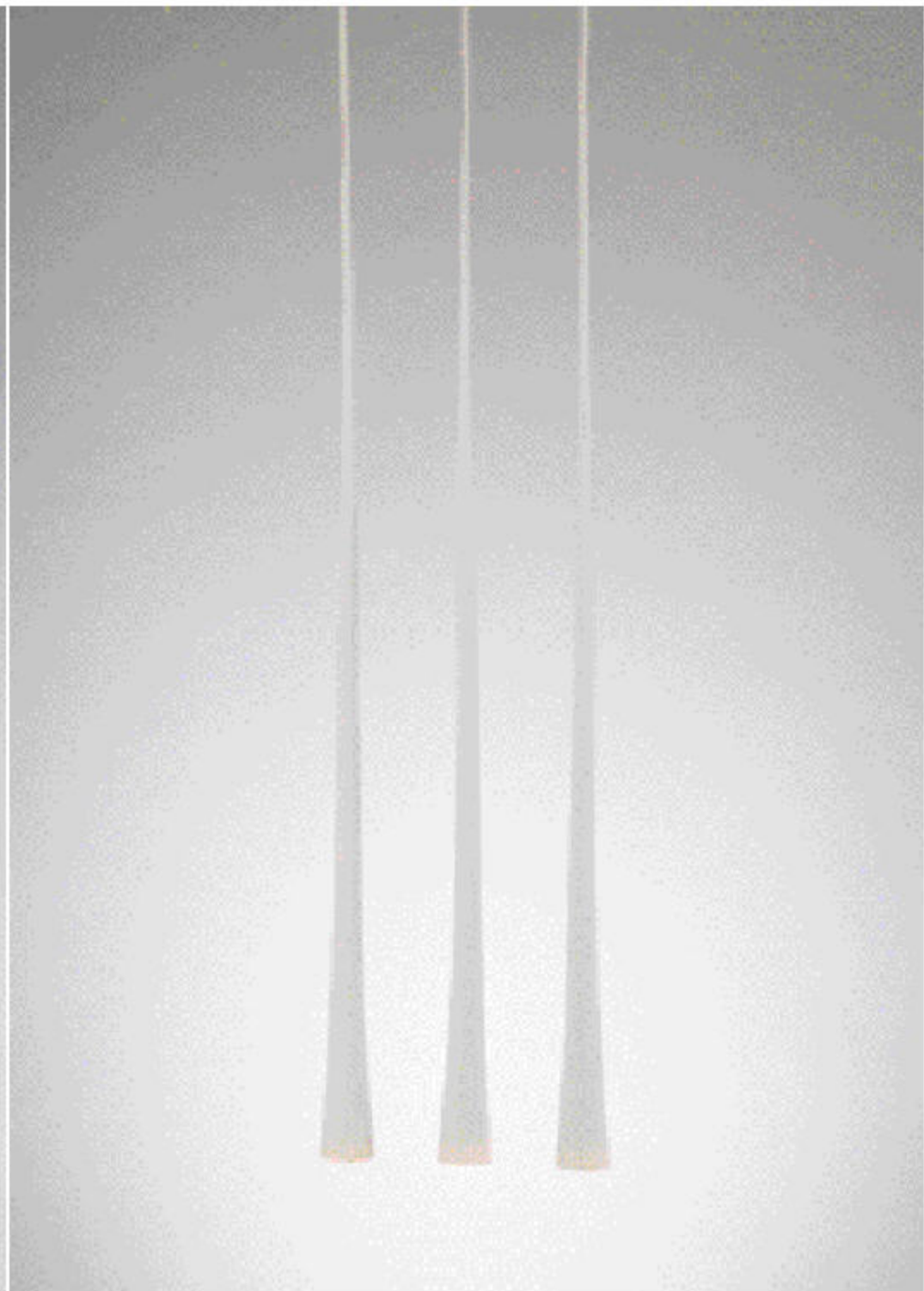
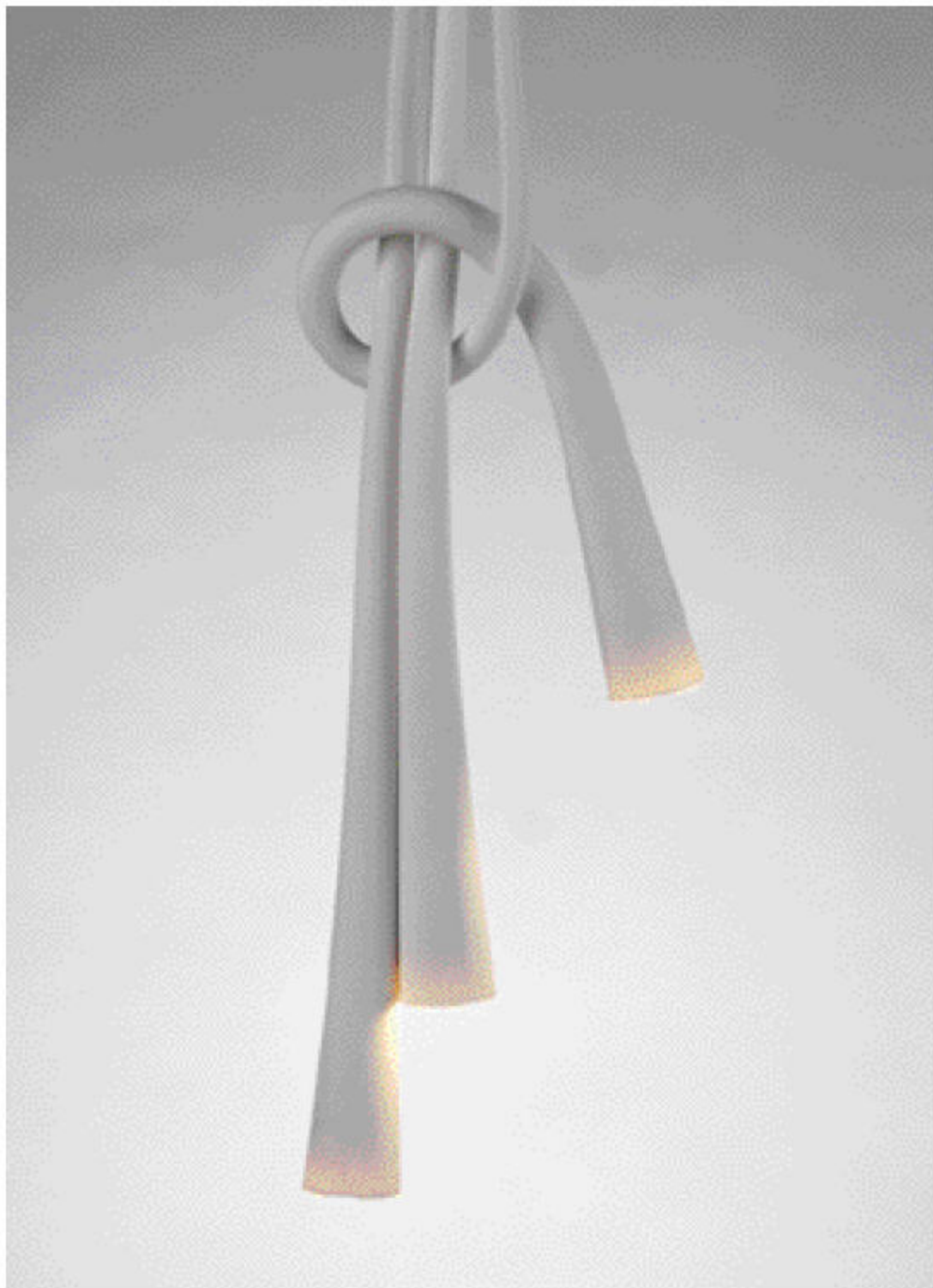

MAJOR TOM

QUASIQASAR COLLECTION

WAND-, VLOER- OF PLAFONDSPOT

Gegoten en gepolijst aluminium.
2 x 360 graden draaibaar tot
een hoek van 32 graden.
Aspherische lens voor brede
spreidingshoek.

**WAND-, FLUR- ODER
DECKENSTRAHLER**

Aluminiumguss poliert.
2 x 360 Grad drehbar bis zu
einem Winkel von 32 Grad.
Aspherische Linse.

**WALL-, FLOOR- OR CEILING
MOUNTED SPOTLIGHT**

Cast aluminium polished.
Rotating 2 x 360 degrees to
an angle of 32 degrees.
Aspheric lens.

APPLIQUE, SOL OU SPOT PLAFOND

Fusion d'aluminium poli,
ajustable à 2 x 360 degrés,
tournable jusqu'à 32 degrés.
Aspheric lens.

1 X GU10 HALOGEN / 50 W

DESIGN:
DE RUYTER-ROEDWINK ONTWERPERS

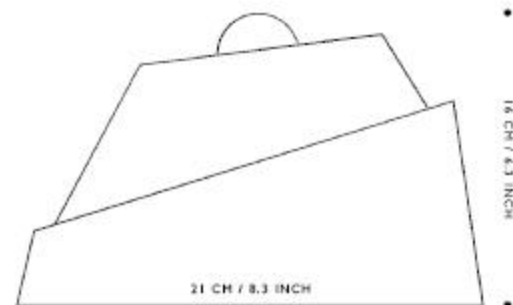

16 CM / 6.3 INCH

21 CM / 8.3 INCH



MIRU

QUASIQVASAR COLLECTION

VLOER- EN TAFELLAMP

Geanodiseerd aluminium en chroom. Scharnieren zijn geconstrueerd met magneten, die het armatuur zowel in hoogte als in richting verstelbaar maken. 2 x 70 graden draaibaar.

STEH- UND TISCHLEUCHTE

Aluminium eloxiert und Chrom. Scharniergelenken sind konstruiert mit Magneten. Hierdurch ist die Leuchte in Höhe und Richtung verstellbar 2 x 70 Grad drehbar.

FLOOR- AND TABLELAMP

Anodised aluminium and chromium. Hinge-joints are constructed with magnets which make it possible to adjust this light in height and direction. Rotating 2 x 70 degrees.

LAMPADAIRE ET LAMPE DE TABLE

Aluminium anodisé et chrome. Les charnières sont prévus d'aimants, qui permettent de régler l'armature en hauteur et en direction. Rotation 2 x 70 degrés.

2 X POWERLED
WHITE / RED / GREEN / BLUE
LENS 10° / 30° / 50°

DESIGN: JOS HULLER

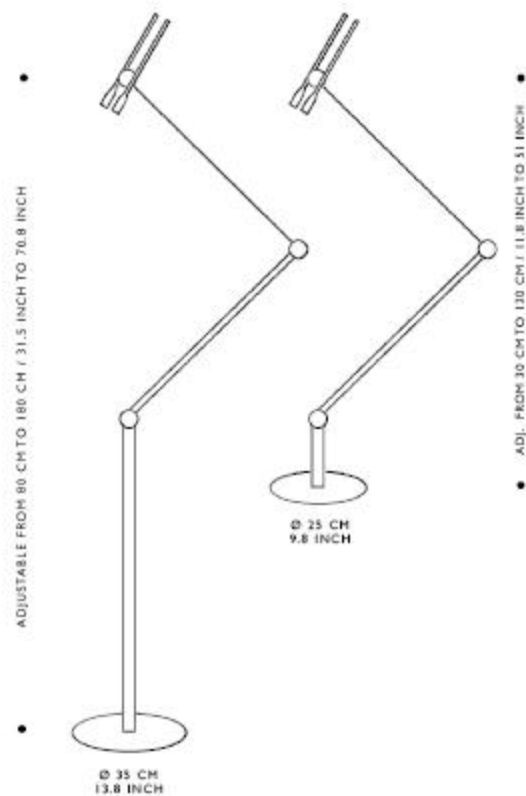



MIRU SPOT

QUASIQVASAR COLLECTION

OPBOUWSPOT

Geanodiseerd aluminium en chroom. Voor opbouw of 3-fase spanningrail.

Scharnier is geconstrueerd met magneten, die het armatuur in hoogte en richting verstelbaar maken.

ANBAUSTRALER

Aluminium eloxiert und Chrom. Für anbau oder 3-Phasen Stromschiene. Scharniergelenk ist konstruiert mit Magneten. Hierdurch ist die Leuchte in Höhe und Richtung verstelbar.

SURFACE MOUNTED SPOT

Anodised aluminium and chromium. For surface mounting or 3-circuit track.

Hinge-joint is constructed with magnets which makes it possible to adjust this light in height and direction.

SPOT APPARENT

Aluminium anodisé et chrome. Spot plafond ou un rail triphasé. Le charnière est prévus d'aimants, qui permet de régler l'armature en hauteur et en direction.

1, 2 OR 3 X POWERLED
WHITE / RED / GREEN / BLUE OR
RGB - OPTIMAL COLOUR-MIX
LENS 10° / 30° / 50°

DESIGN: JOS MULLER

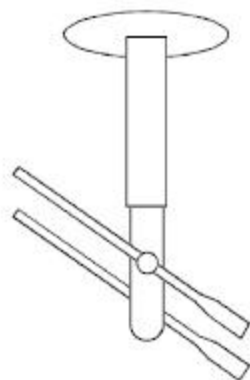
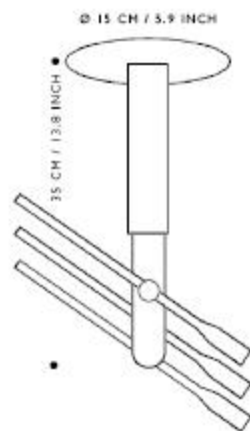
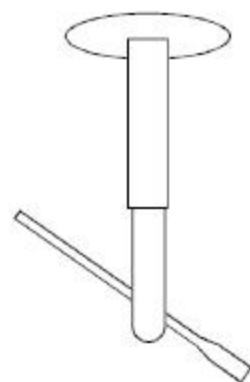

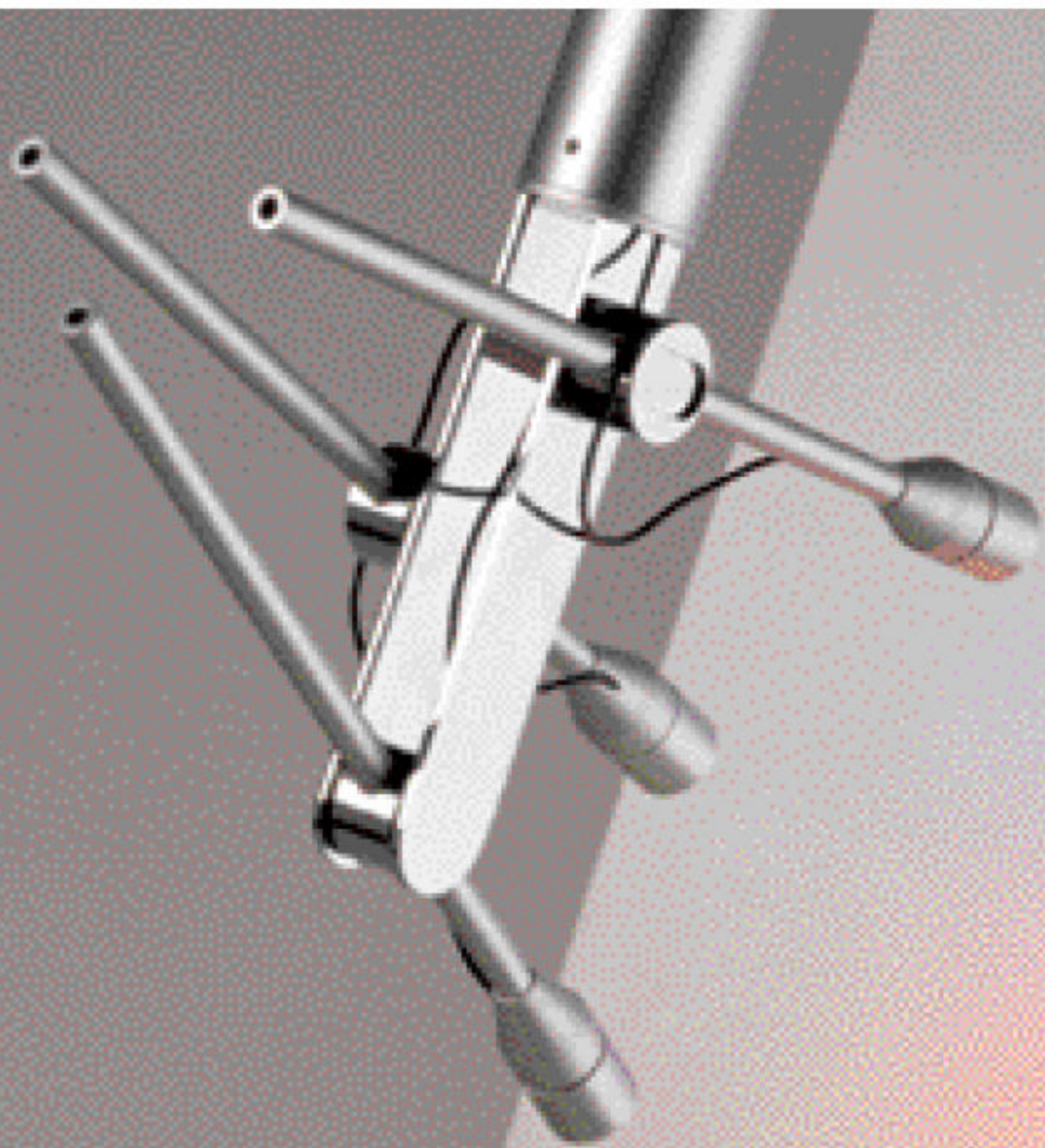

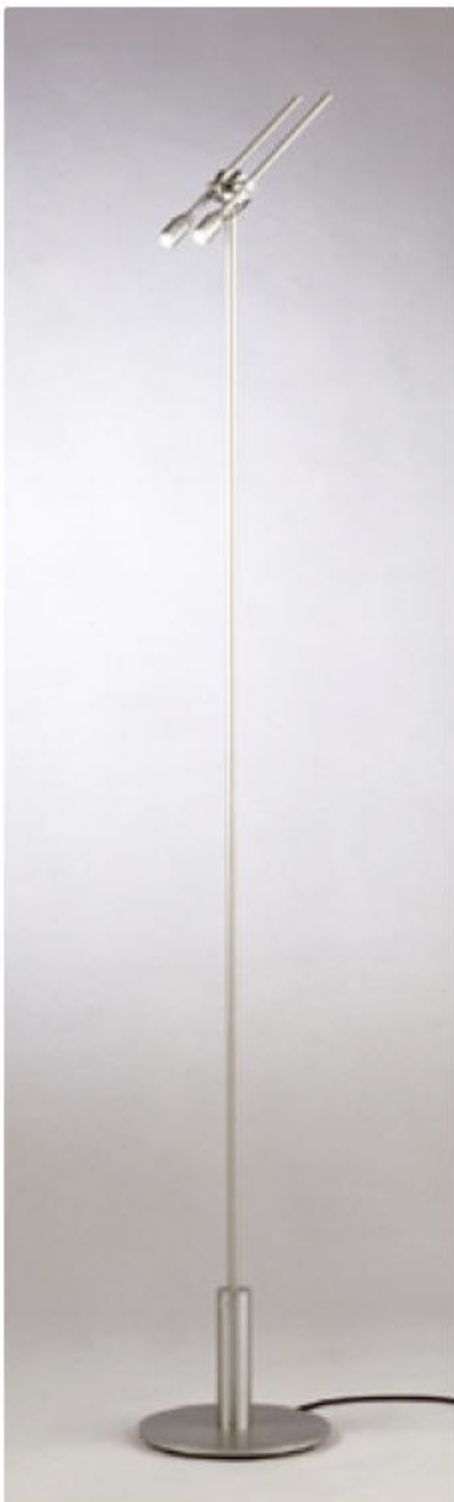

MIRU XL

QUASIQUASAR COLLECTION

VLOERLAMP EN PLAFONNIÈRE

Geanodiseerd aluminium.
Scharnier is geconstrueerd met magneten, dat het armatuur in richting verstelbaar maakt.

STEH- UND DECKENLEUCHTE

Aluminium eloxiert.
Scharniergelenk ist konstruiert mit Magneten. Hierdurch ist die Leuchte in Richtung verstellbar.

FLOOR- AND CEILINGLAMP

Aluminium anodised.
Hinge-joint is constructed with magnets which makes it possible to adjust this light in direction.

LAMPADAIRE ET PLAFONNIER

Aluminium anodisé.
Le charnière est prévu d'aimants, qui permet de régler l'armature en direction.

2 X POWERLED
WHITE / RED / GREEN / BLUE
LENS 10° / 30° / 50°

DESIGN: JOE HULLER

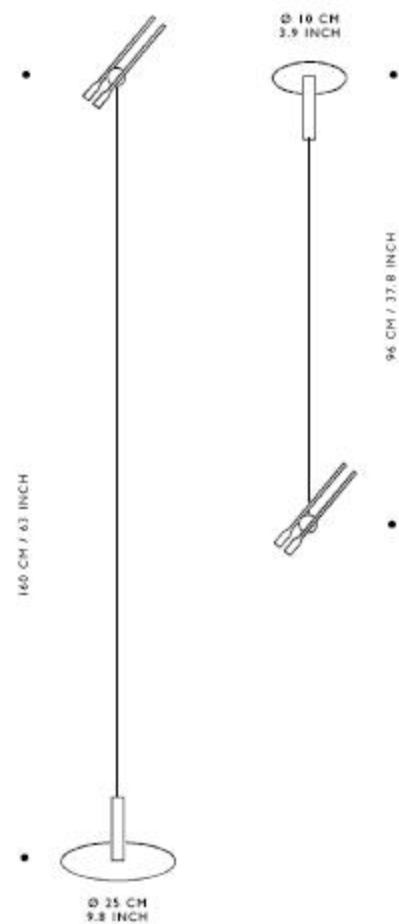

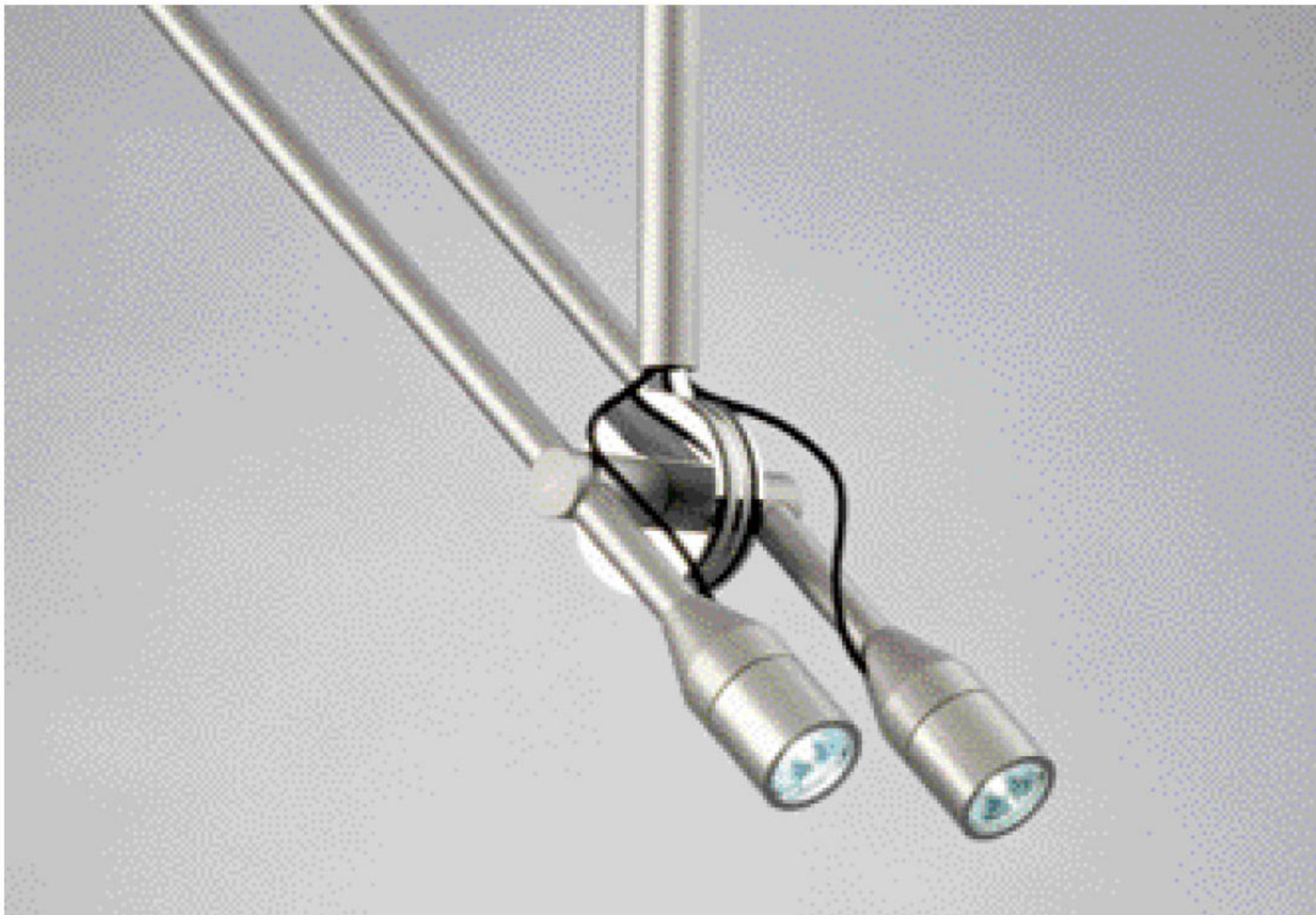

ON-OFF LIGHT

QUASIQVASAR COLLECTION

VLOERLAMP

Gegoten aluminium en RVS.
Kap Liniel gecoat
met katoen.

STEHLEUCHE

Aluminiumguss und Edelstahl.
Schirm Liniel, überzogen
mit Baumwolle.

FLOORLAMP

Casted aluminium and
stainless steel.
Shade Liniel coated
with cotton.

LAMPADAIRE

Fusion d'aluminium et
acier inoxydable.
Abat-jour en Liniel avec coton
imperméabilisé.

1 X E27 / 60W

DESIGN: PETER MAC CARR & DAVID LANCASTER



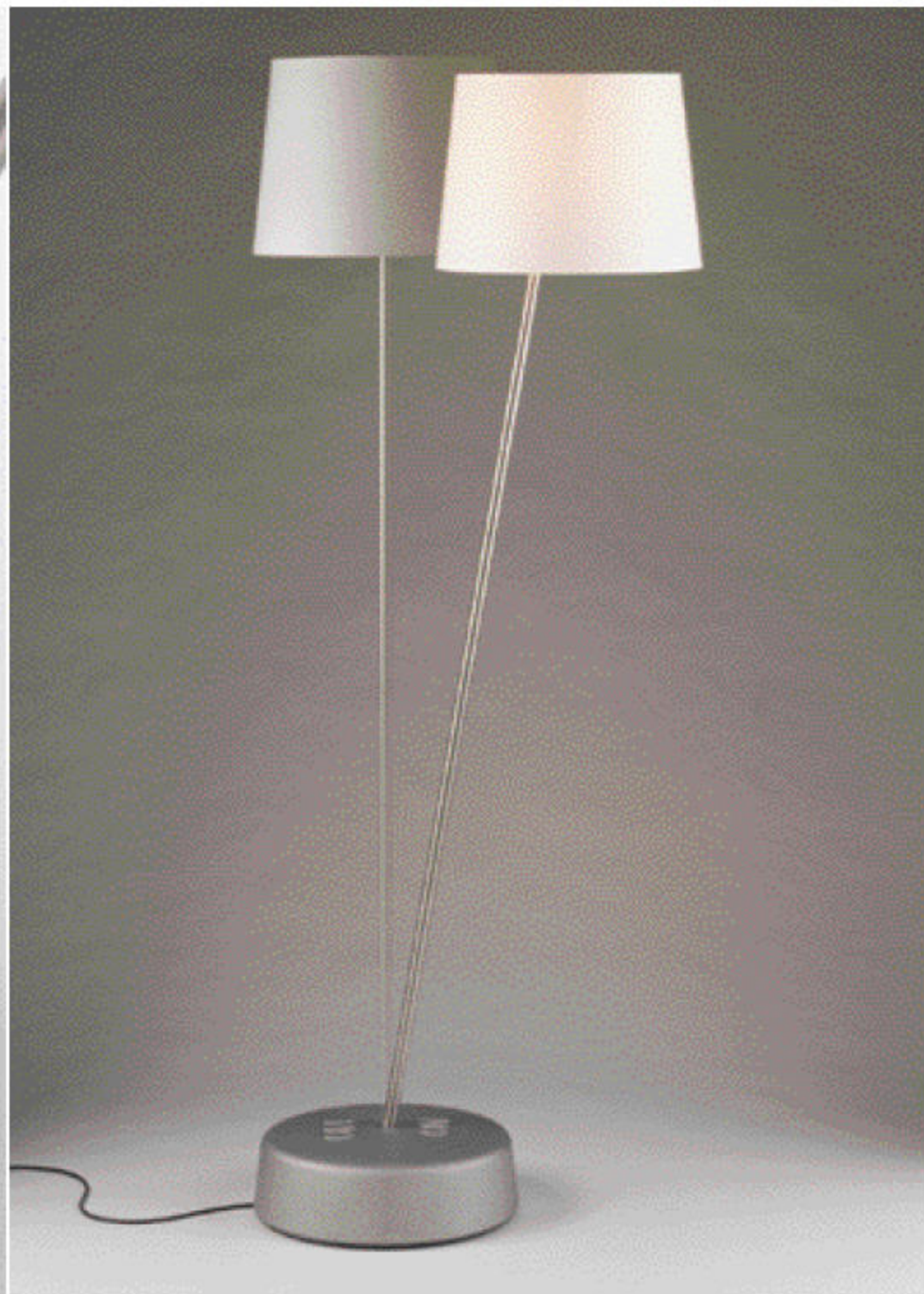

SOL - AIR

QUASIQUASAR COLLECTION

VLOERLAMP

Carbonfiber, RVS en glas.
Met dimmer.

STEHLEUCHTE

Karbonfiber, Edeldstahl und Glas.
Mit Dimmer.

FLOORLAMP

Carbone fibre,
stainless steel and glass.
With dimmer.

LAMPADAIRE

Fibre carbone, acier
Inoxidable et verre.
Avec variateur.

1 X G4 / 20W HALOGEN

DESIGN: NATHALIE DEWEZ

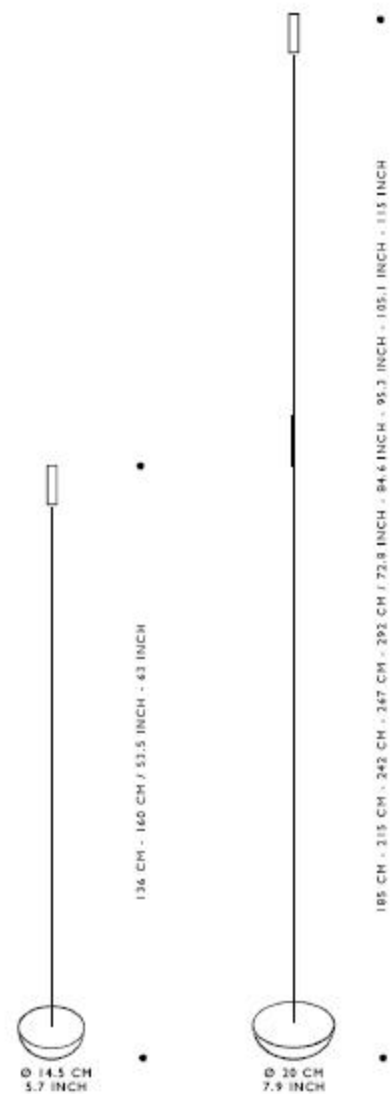

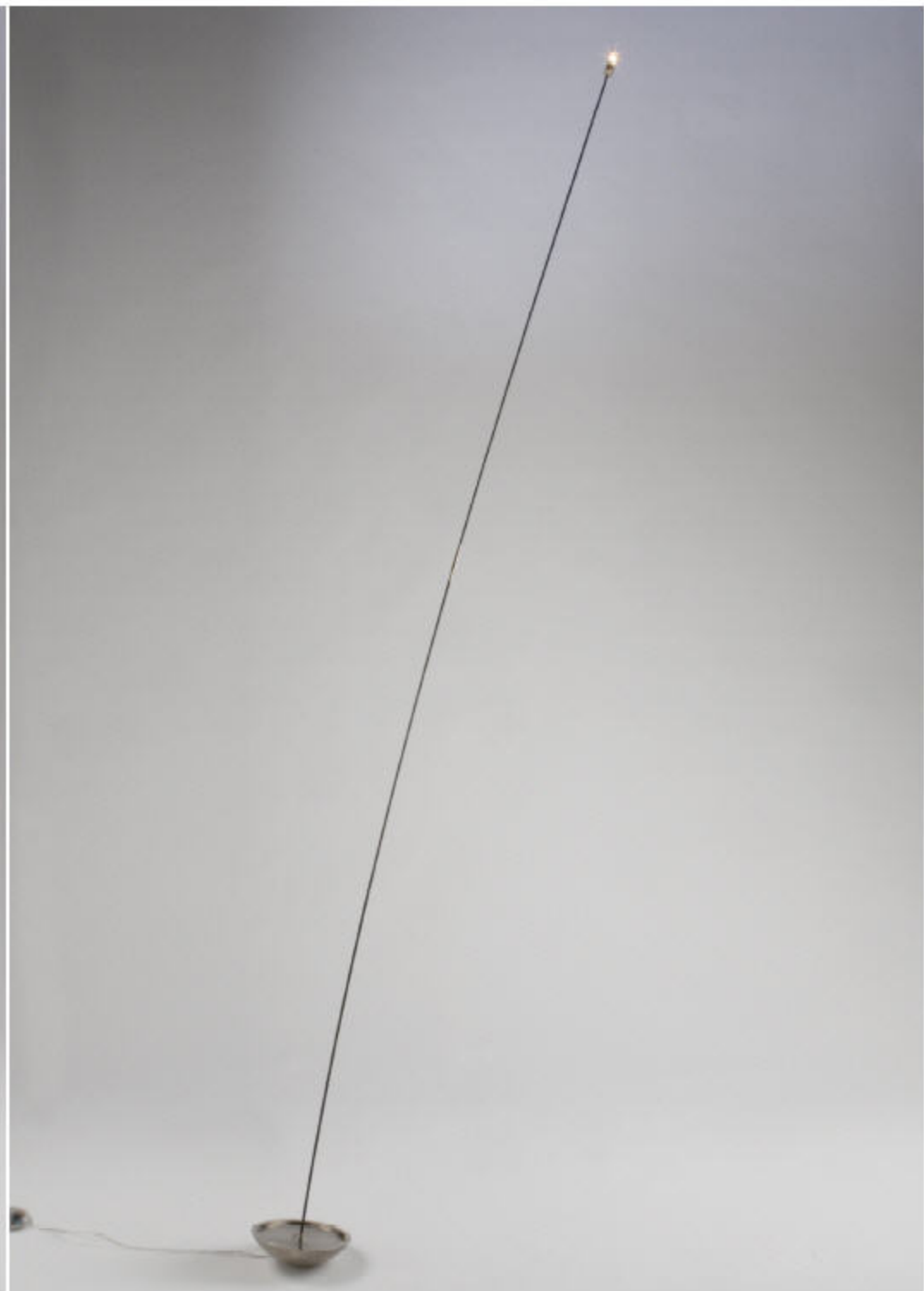



TULIP

QUASIQUASAR COLLECTION

VLOER-, TAFEL- EN HANGLAMP
RVS-en nikkel.
Kap Evacast met
aluminium ritsluitingen.
*Met dimmer.

STEH-, TISCH- UND HÄNGELEUCHTE
Edelstahl und Nickel.
Evacast Schirm mit
Aluminium Reissverschluss.
*Mit Dimmer.

**FLOOR-, TABLE- AND
SUSPENDED LAMP**
Stainless steel and nickel.
Shade Evacast with
aluminium zip-fastener.
*With dimmer.

**LAMPADAIRE, LAMPE DE TABLE ET
SUSPENSION**
Acier inoxydable avec nickel.
Abat-jour Evacast avec
fermeture-éclair d'aluminium.
*Avec variateur

1 X E14 / 40W
1 X E27 / 60W / VLOERLAMP /
STEHLEUCHTE / FLOORLAMP /
LAMPADAIRE

DESIGN: SYBILLE HEVISEN

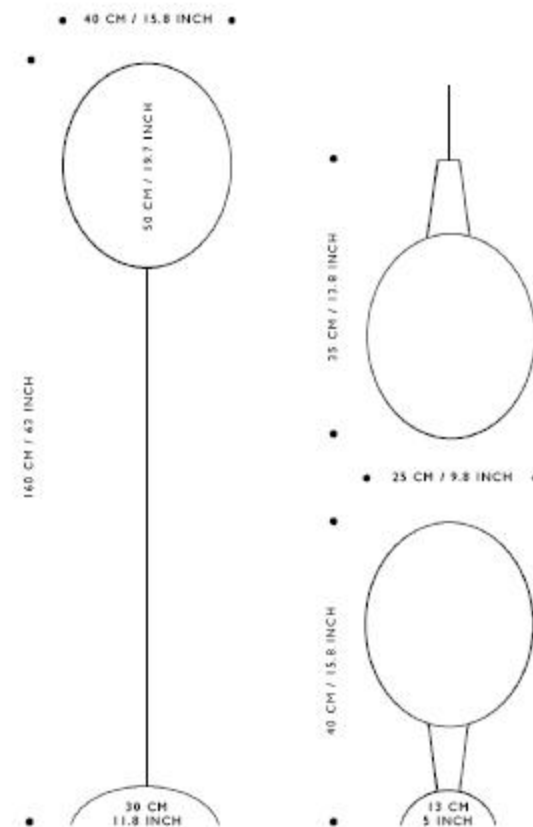

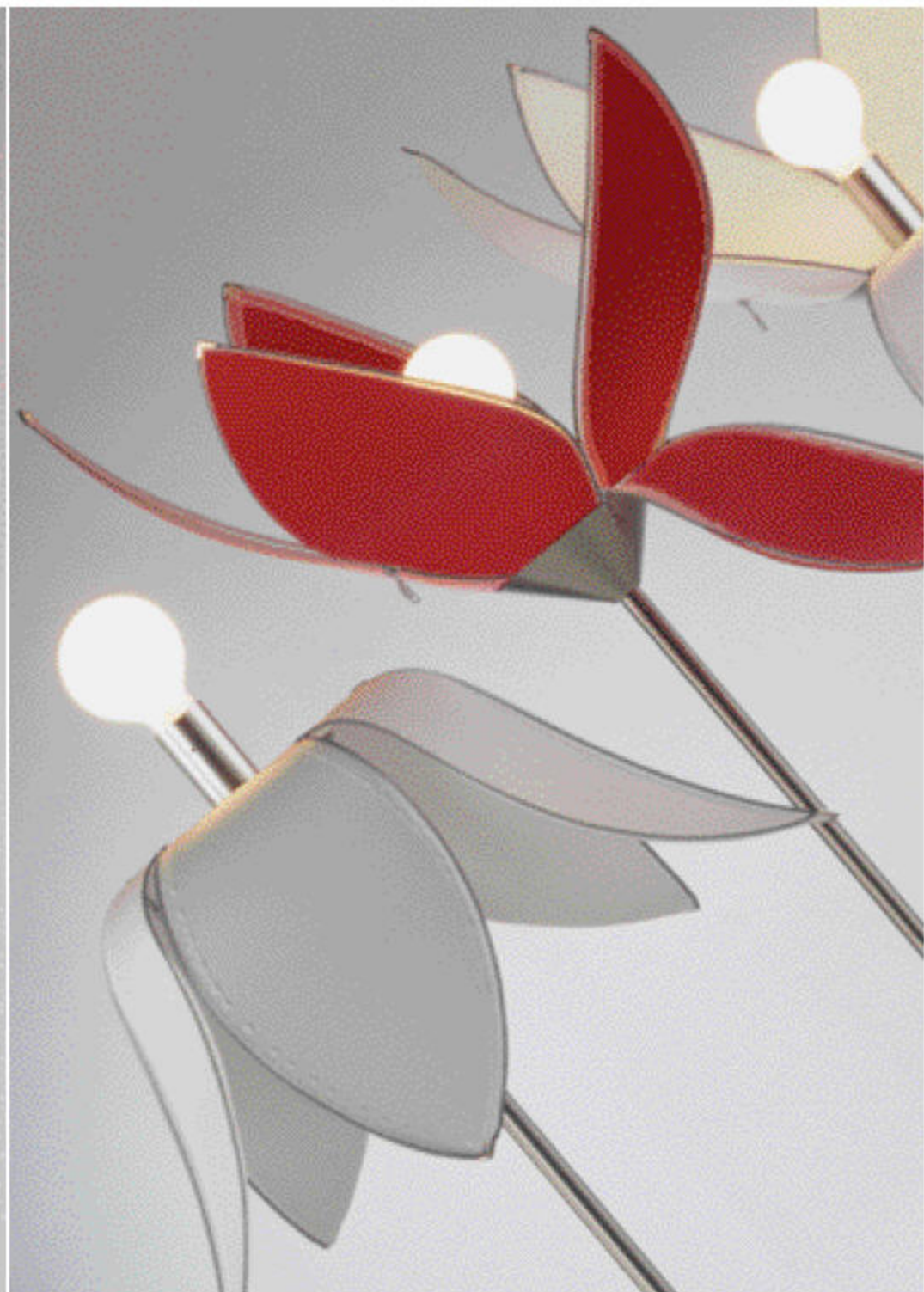

...ET IL POSSIBLE DE LAVOIR PLUS ÉTROIT?... ET IL POSSIBLE DE LAVOIR PLUS LARGE?... ET IL POSSIBLE DE LAVOIR PLUS GRANDE?... ET IL POSSIBLE DE LAVOIR PLUS PETIT?...ET IL POSSIBLE DE LAVOIR EN ARGENT?...EN D'ORÉ?...AUSSI EN ACIER INOXIDABLE?...EN BRONZE?...EN LAITON?... ET IL POSSIBLE DE LAVOIR EN SUSPENSION?... ET IL POSSIBLE DE LIVRER Á DOMICILE?...AU VENIR CHERCHER?... ET IL POSSIBLE DE LAVOIR DANS D'AUTRES COULEURS?...ROUGE?...EST CE QUE VOUS FAITES ÇA DEPUIS LONGTEMPS?...EST CE QUE VOUS INVENTER TOUS VOUSMÊMES?...ET IL POSSIBLE L'ALUMER?... ET IL POSSIBLE L'ÉTAINDRE?...

O

U

!

!

F O Q U S

C O L L E C T I O N



YOUNGHAPPYCONSTRUCTFRAGILEFAIRYTALE

JUNGFROHKONSTRUKTIVZARTTRAUMHAFT

JEUNEALLÉGRESSECONSTRUCTIVEFRAGILEFÉERIQUE

JONGVROLIJKONSTRUKTIEFFRAGIELSPROOKJESACHTIG

BIRD

FOCUS COLLECTION

HANGLAMP

Mat messing of mat nikkel.
Veren zijn optioneel.

HÄNGELEUCHTE

Messing mattiert oder
matt vernickelt.
Federn sind optionel.

SUSPENDED LAMP

Brass deadened or nickel deadened.
Feathers are optional.

SUSPENSION

Laiton mat ou nickel mat.
Plumes sur demande.

76 x E5/8 / 1,2W / 6V

1 x GY6,35 / 75W / 12V

DESIGN: JAM PAUWELS

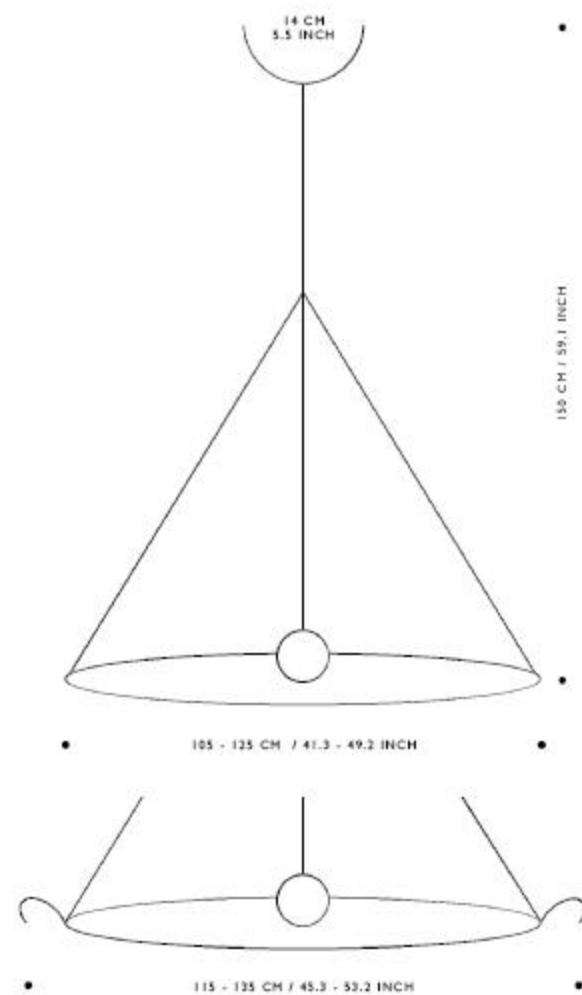

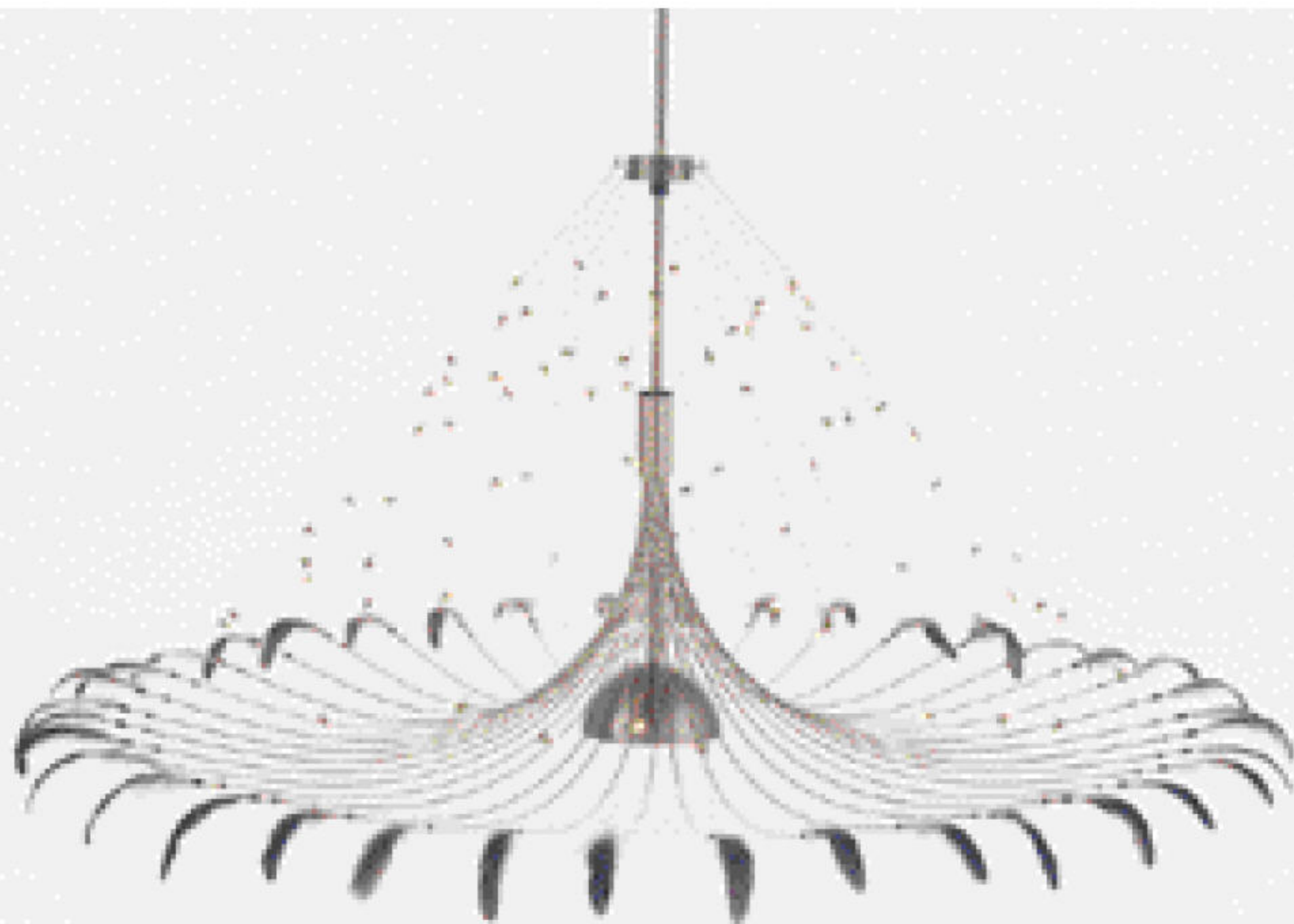

CITADEL

FOCUS COLLECTION

TAFELLAMP

Mat messing of mat nikkel.
Voet natuursteen.

TISCHLEUCHTE

Messing mattiert oder matt
vernickelt. Fuss Naturstein.

TABLELAMP

Brass deadened or nickel deadened.
Foot natural stone.

LAMPE DE TABLE

Laiton mat ou nickel mat.
Pierre de taille.

1 x E14 / 40W

DESIGN: JAM PAUWELS

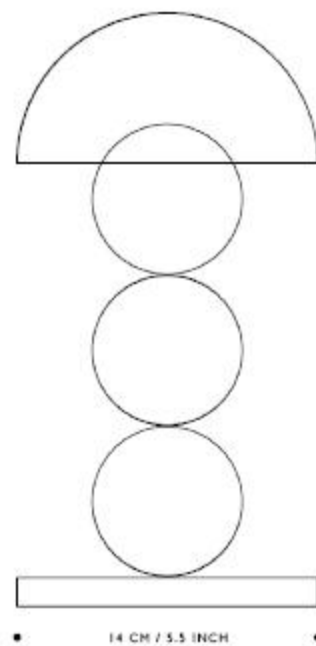
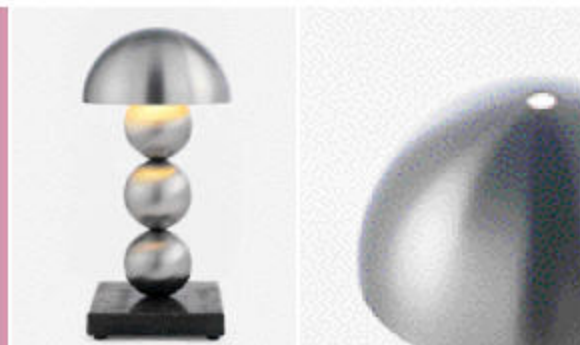

39 CM / 11.4 INCH

14 CM / 5.5 INCH

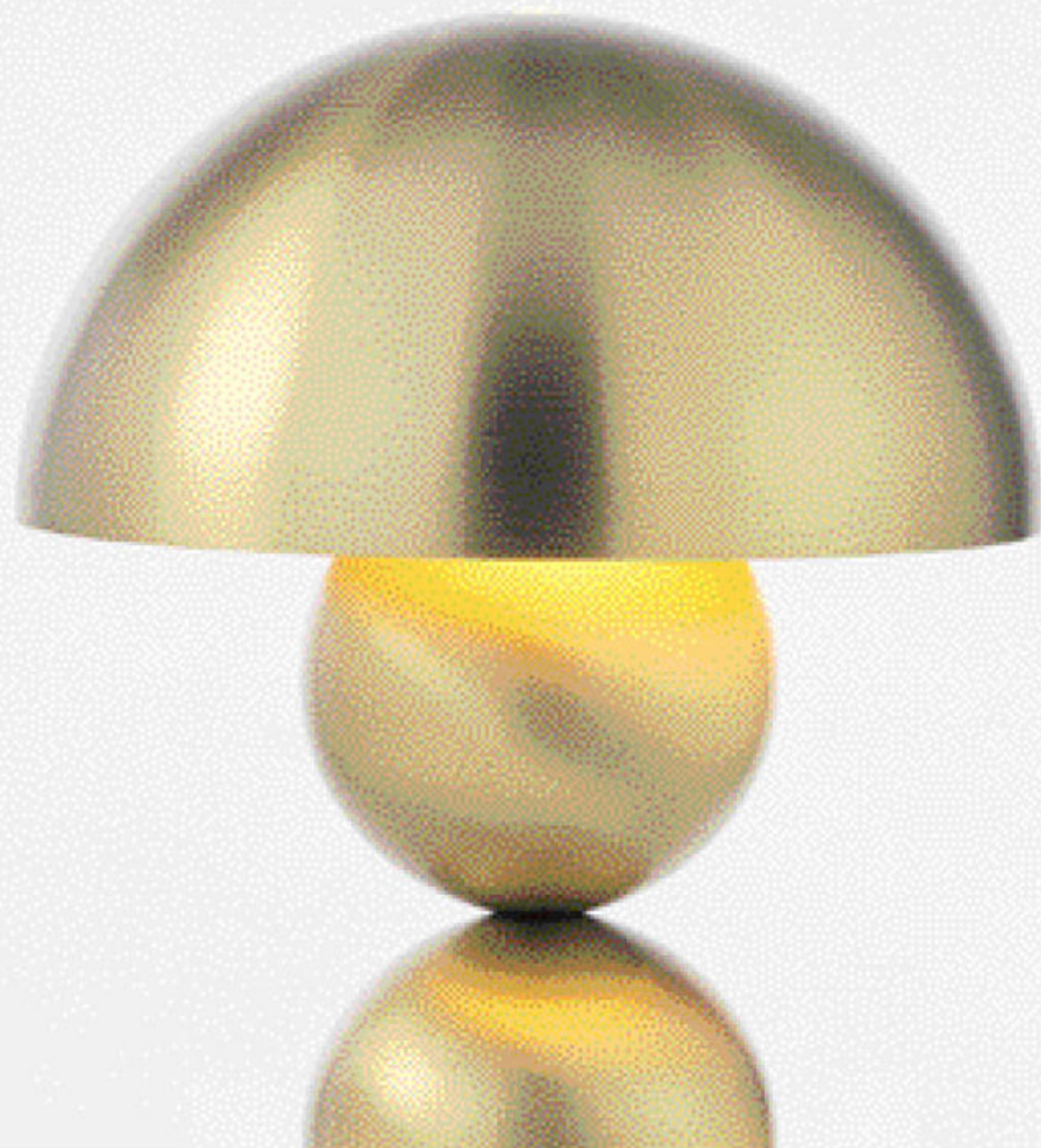

CITADEL GRANDE

FOCUS COLLECTION

HANGLAMP

Koper, messing of nikkel mat.

HÄNGELEUCHTE

Kupfer, Messing oder Nickel.

SUSPENDED LAMP

Copper, brass or nickel deadened.

SUSPENSION

Cuivre, Laiton ou nickel mat.

136 x E10 / 1,2W / 12V

DESIGN: JAM PAUWELS

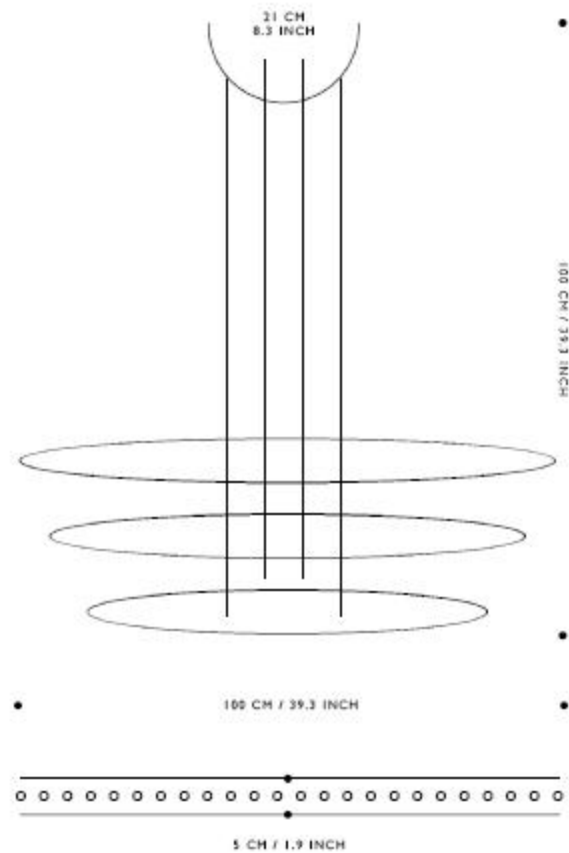

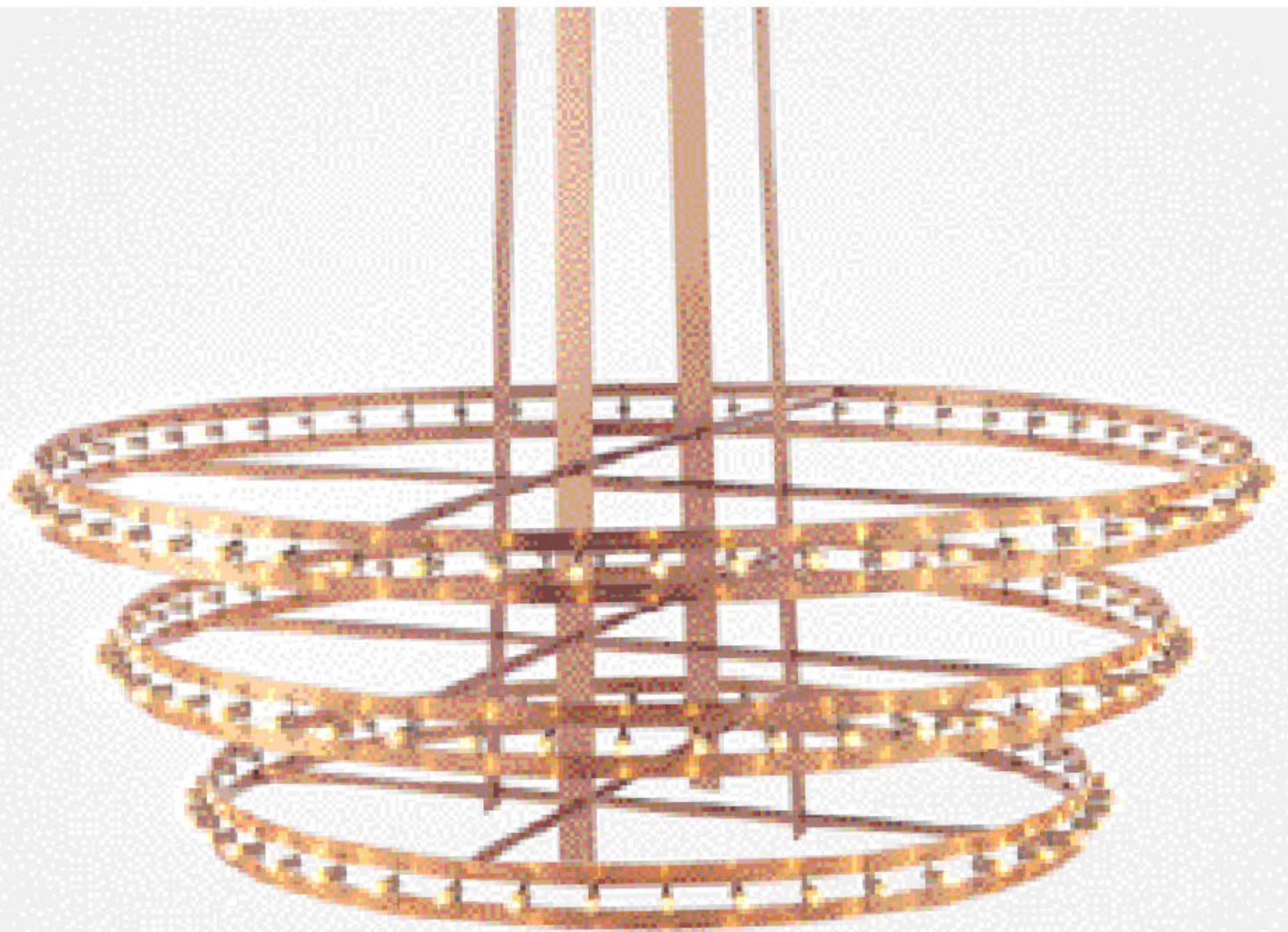

CITADEL COMPOSITION

FOCUS COLLECTION

HANGLAMP

Koper, messing of nikkel mat.

HÄNGELEUCHTE

Kupfer, Messing oder Nickel.

SUSPENDED LAMP

Copper, brass or nickel deadened.

SUSPENSION

Cuivre, Laiton ou nickel mat.

100cm = 60 x E10 / 1,2W / 12V

89cm = 52 x E10 / 1,2W / 12V

78cm = 44 x E10 / 1,2W / 12V

DESIGN: JAM PAUWELS



14 - 14 - 21 CM
5.5 - 5.5 - 8.3 INCH

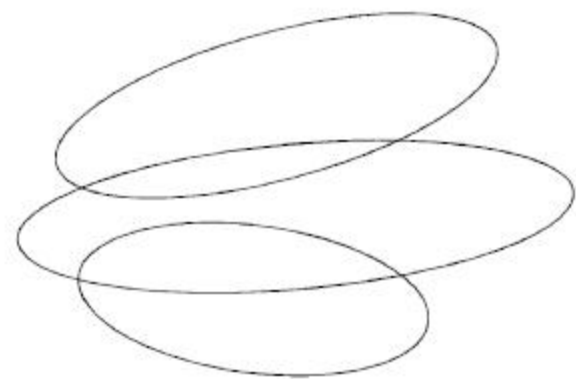

78 - 89 - 100 CM
30.7 - 35 - 39.3 INCH



5 CM / 1.9 INCH



EXTASE

FOCUS COLLECTION

HANGLAMP

Mat messing of mat nikkel.

HÄNGELEUCHTE

Messing mattiert oder
matt vernickelt.

SUSPENDED LAMP

Brass deadened or nickel deadened.

SUSPENSION

Laiton mat ou nickel mat.

38 x E5/8 / 1,2W / 12V

1 x GY6,35 / 50W / 12V

DESIGN: JAM PAUWELS

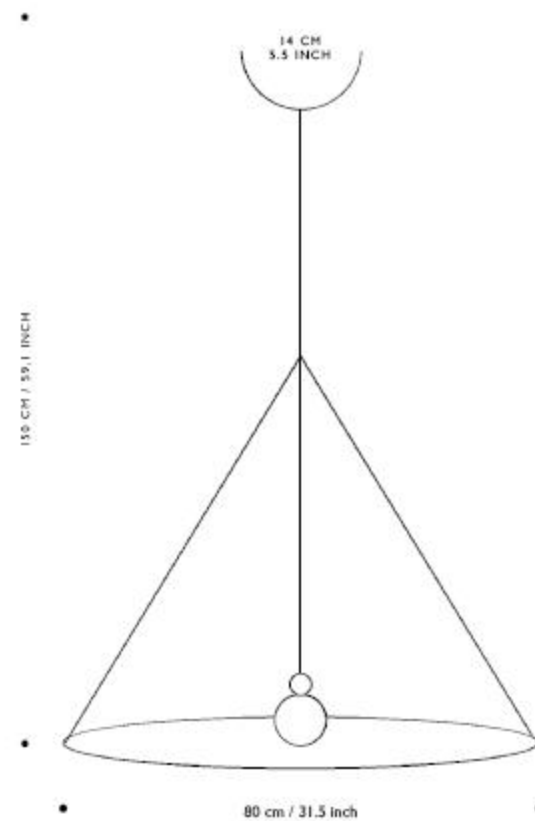

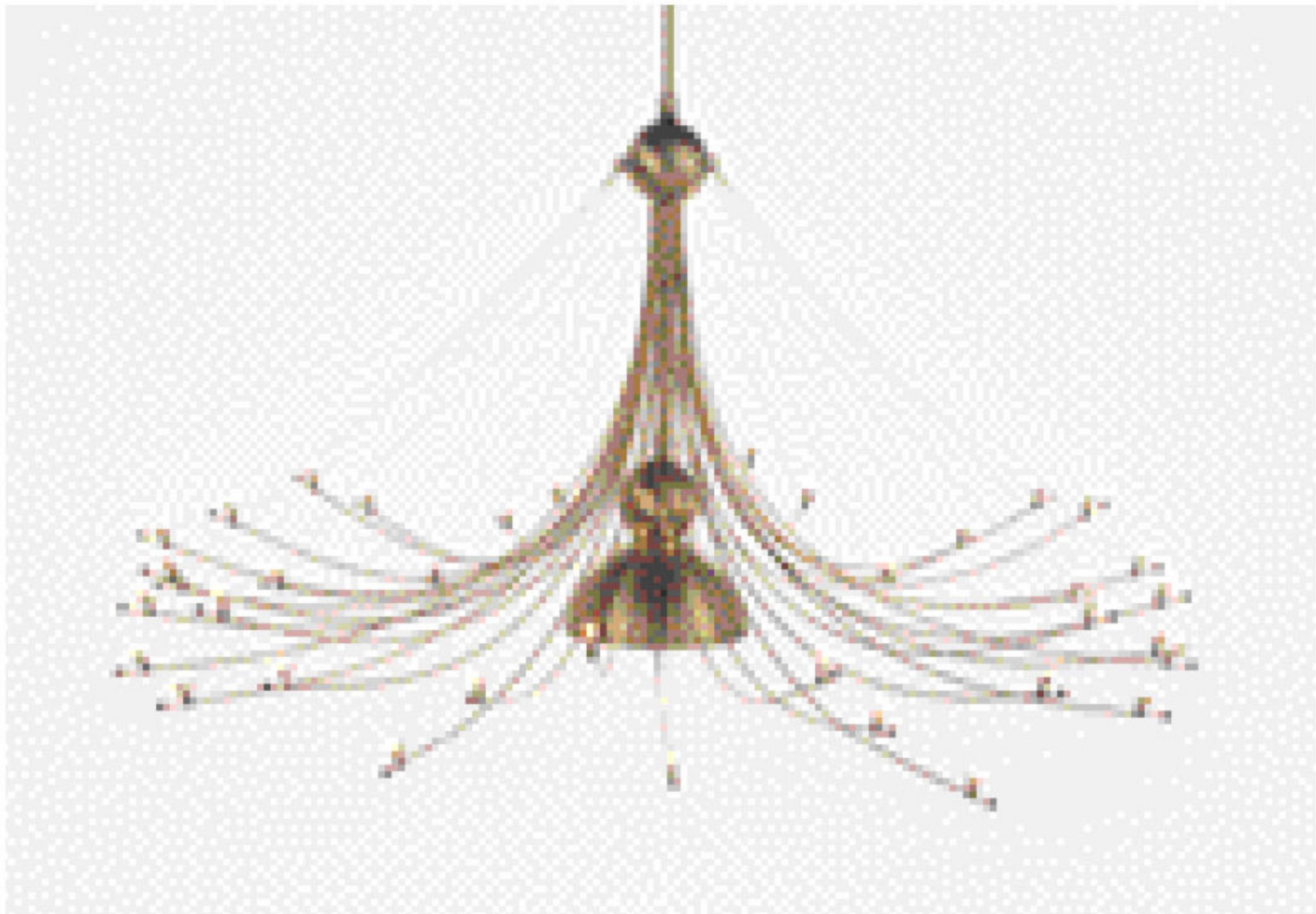

FIELTEBEK

FOQUS COLLECTION

HANGLAMP

Mat messing of mat nikkel.

HÄNGELEUCHTE

Messing oder Nickel
mattiert.

SUSPENDED LAMP

Brass or nickel deadened.

SUSPENSION

Laiton ou nickel mat.

120cm = 48 x E10 / 3W / 12V

150cm = 60 x E10 / 3W / 12V

200cm = 80 x E10 / 3W / 12V

DESIGN: JAM PAUWELS

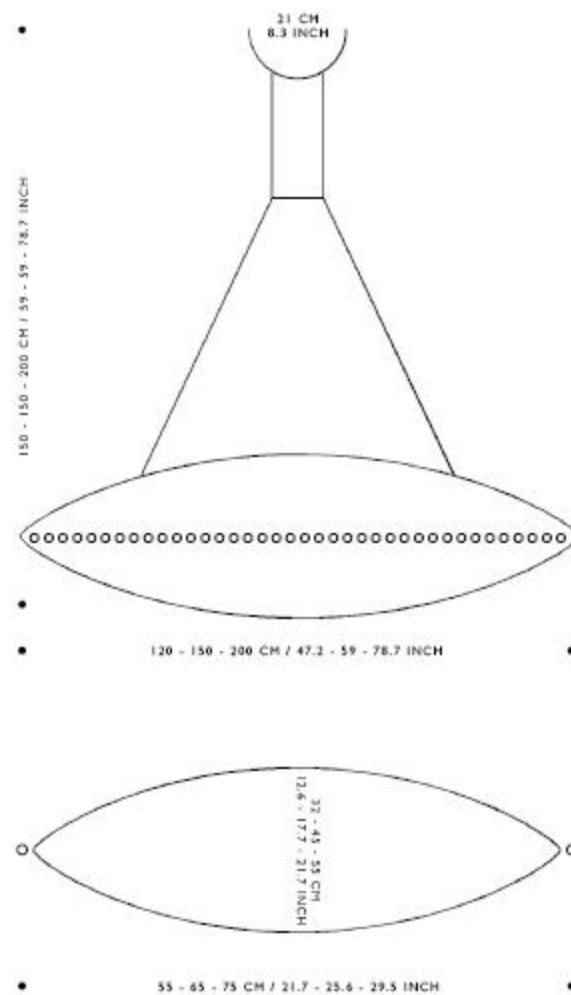

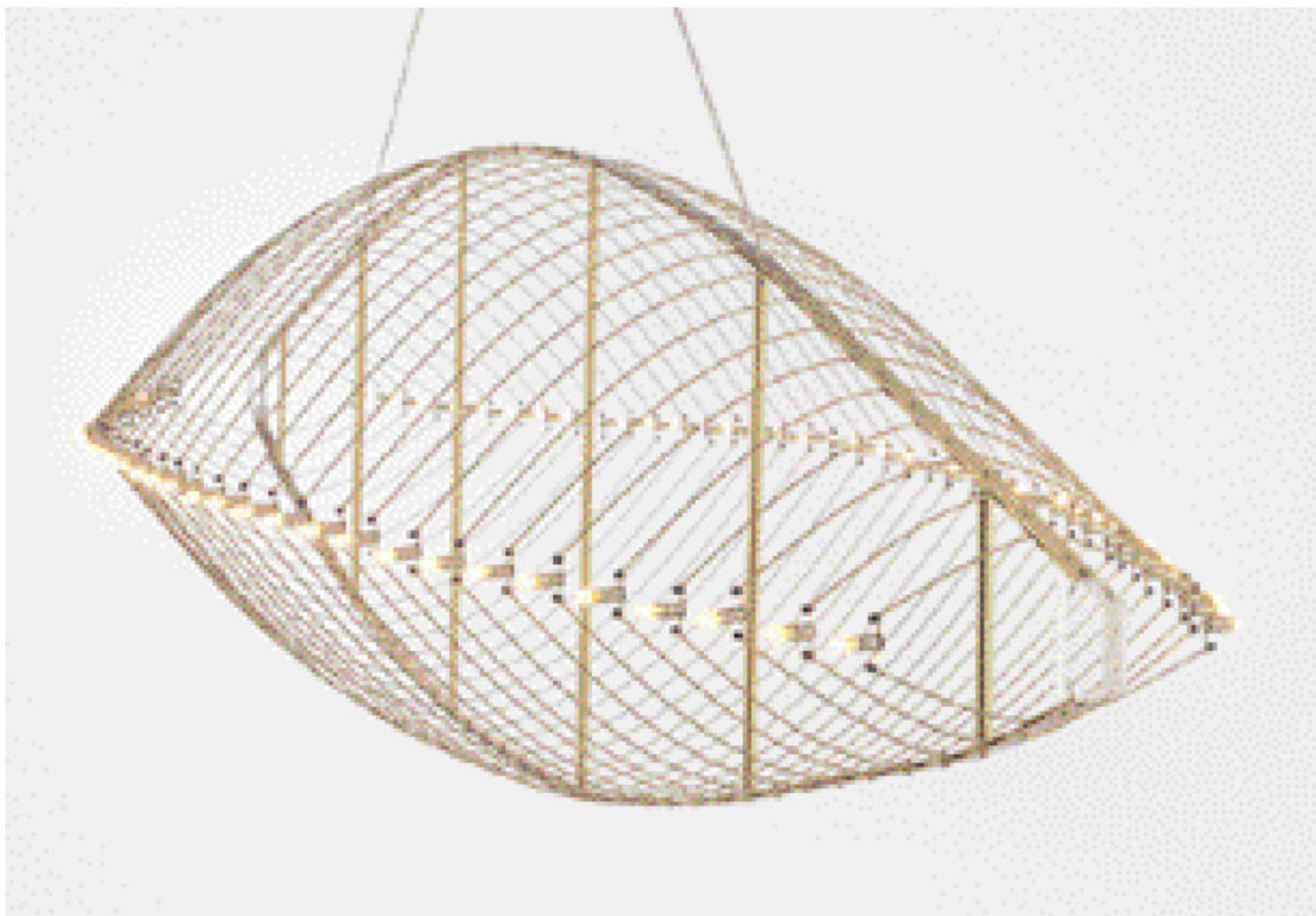

FIELTEBEK SYSTEM

FOQUS COLLECTION

HANGLAMP

Mat messing of mat nikkel.
Leverbaar in elke gewenste lengte.

HÄNGELEUCHTE

Messing oder Nickel mattiert.
Lieferbar in jeder Länge.

SUSPENDED LAMP

Brass or nickel deadened.
Length made to order.

SUSPENSION

Laiton ou nickel mat.
Longeur sur mesure.

100CM = 40 X E10 / 3W / 12V

200CM = 80 X E10 / 3W / 12V

etc.

DESIGN: JAM PAUWELS

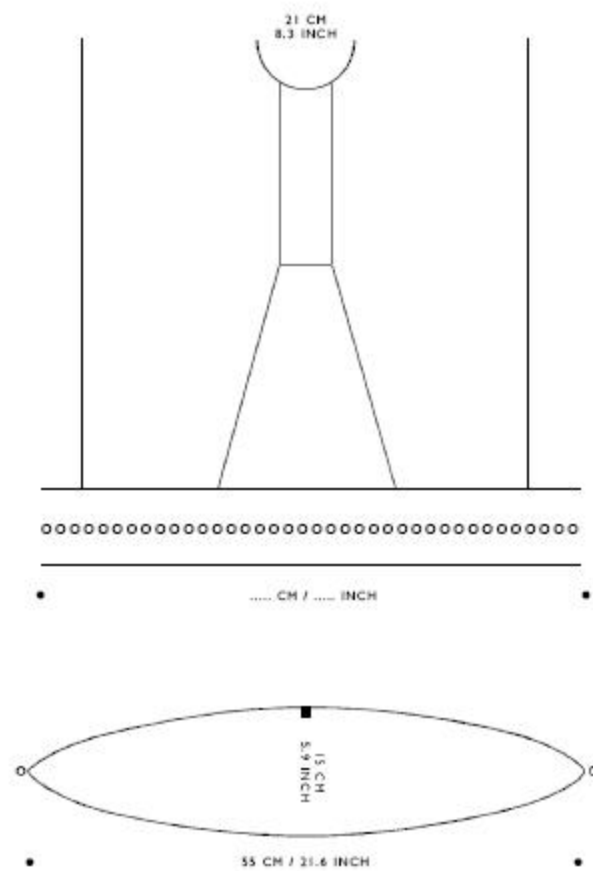
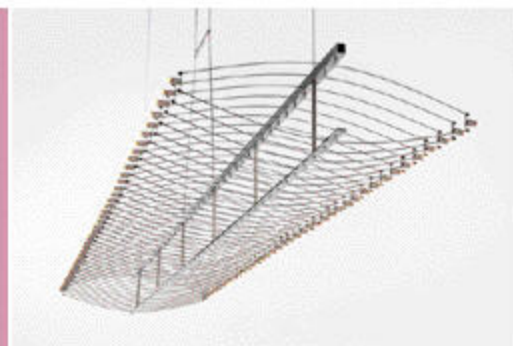

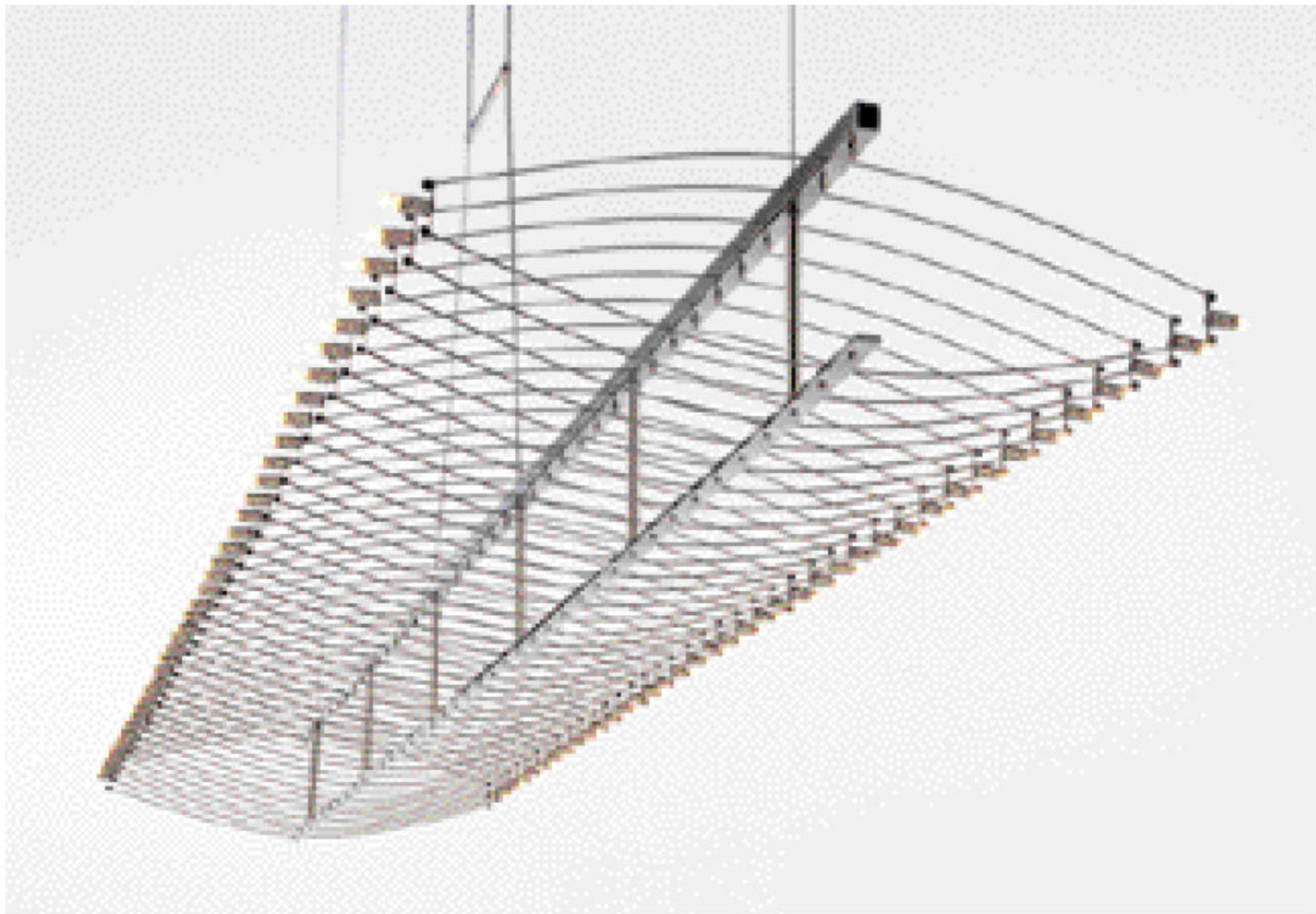

MOON

FOCUS COLLECTION

TAFELLAMP

Mat messing of mat nikkel.
Voet natuursteen.

TISCHLEUCHTE

Messing mattiert oder matt
vernickelt. Fuss Naturstein.

TABLELAMP

Brass deadened or nickel deadened.
On a polished natural stone.

LAMPE DE TABLE

Laiton mat ou nickel mat.
Pierre de taille.

1 x E14 / 40W

DESIGN: JAN PAUWELS

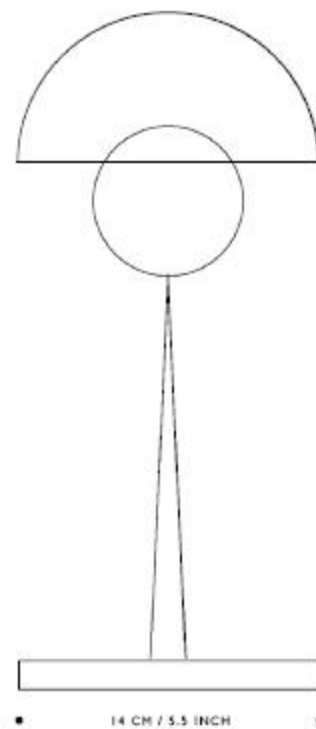

42 CM / 16.5 INCH

14 CM / 5.5 INCH

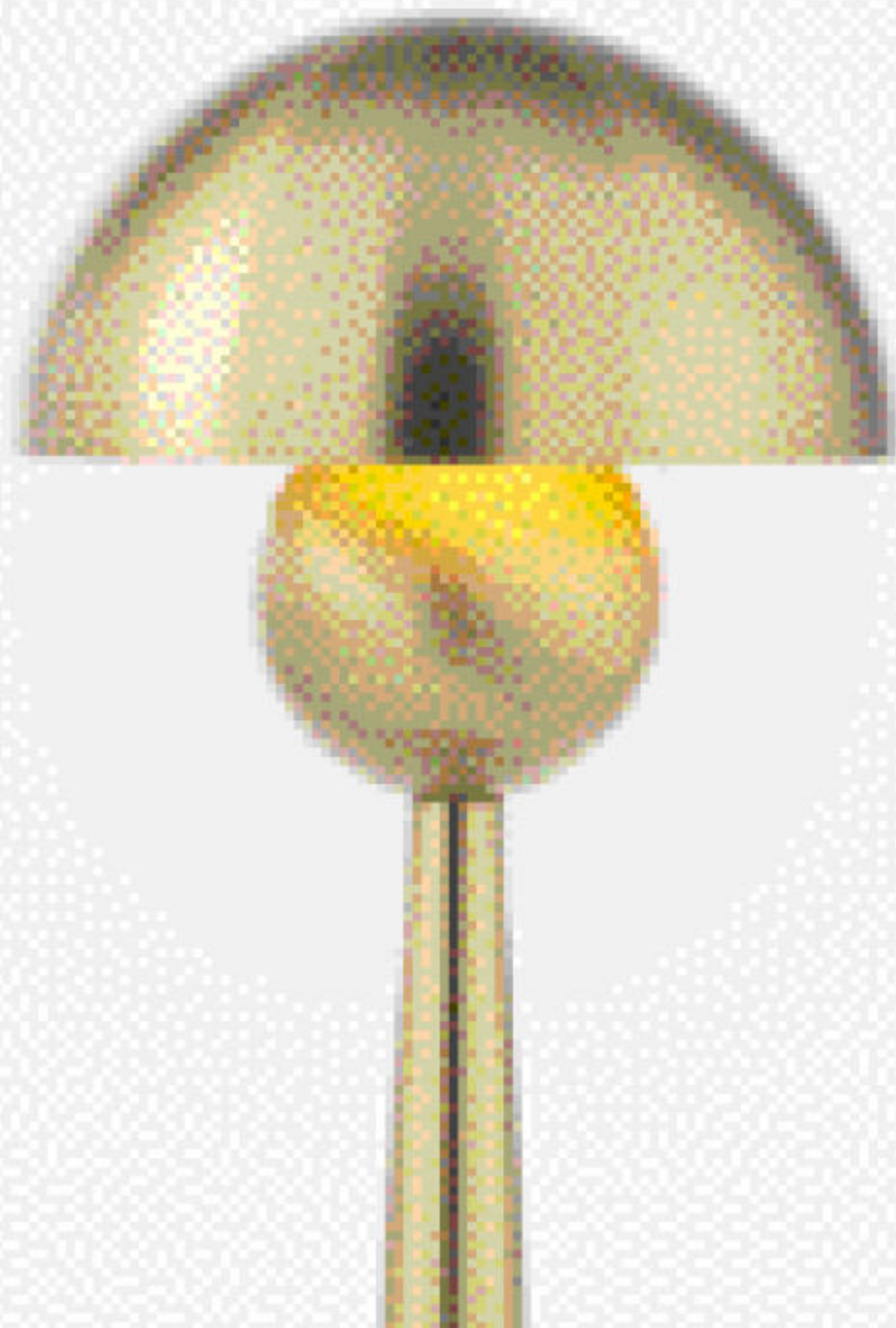

NARITA KIN / GIN

FOCUS COLLECTION

HANGLAMP

Mat messing (Kin) of
mat nikkel (Gin).
Met zijde.

HÄNGELEUCHTE

Messing mattiert (Kin)
oder matt vernickelt (Gin).
Mit Seiden.

SUSPENDED LAMP

Brass deadened (Kin) or
nickel deadened (Gin).
With silk.

SUSPENSION

Laiton mat (Kin) ou
nickel mat (Gin).
Avec soie.

2 x KRISTALLINE / 120W ONLY 230V

DESIGN: JAM PAUWELS

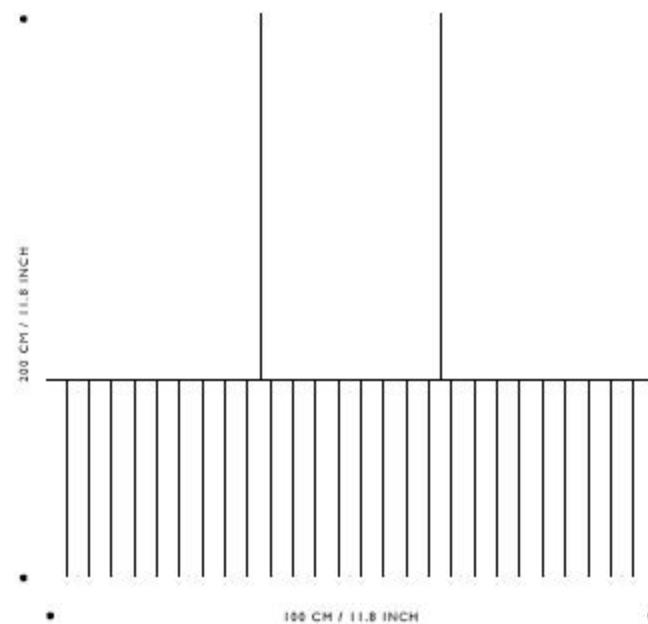
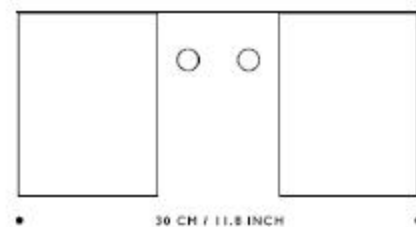
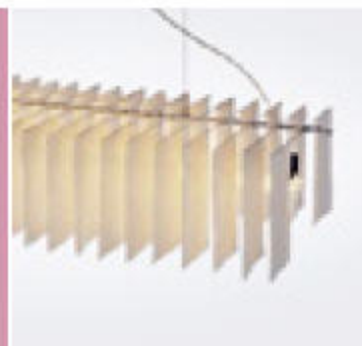

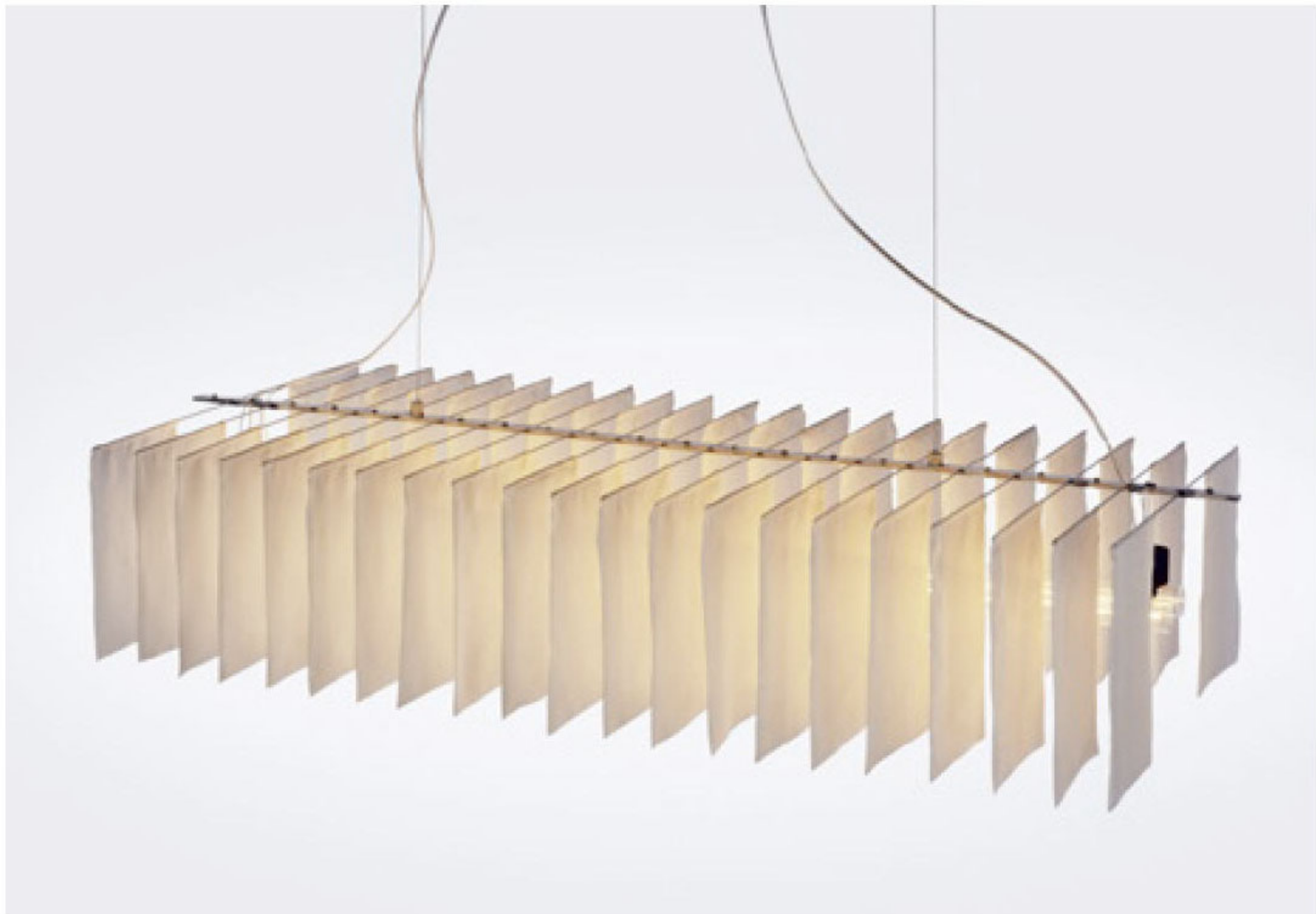

NOBILIS

FOCUS COLLECTION

HANGLAMP

Messing of nickel.

HÄNGELEUCHE

Messing oder Nickel.

SUSPENDED LAMP

Brass or nickel.

SUSPENSION

Laiton ou nickel.

SMALL

66 X E10 / 1,2W

GRANDE

193 X E10 / 1,2W

DESIGN: JAM PAUWELS

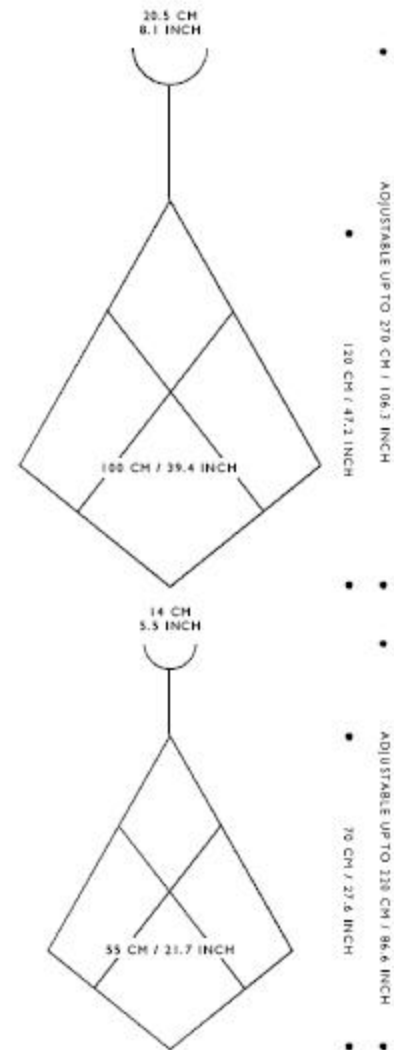
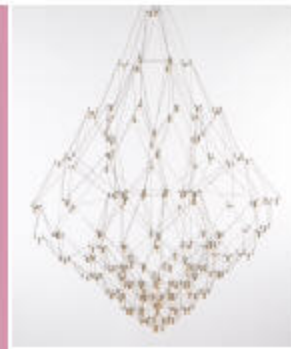



ORKJE

FOCUS COLLECTION

HANG- EN WANDLAMP

Mat messing of mat nikkel.

WAND- UND HÄNGELEUCHEMessing mattiert oder
matt vernickelt.**SUSPENDED AND WALL-LAMP**

Brass deadened or nickel deadened.

SUSPENSION ET APPLIQUE

Laiton mat ou nickel mat.

ORKJE

8 x E5/8 / 1,2W / 12V

1 x GU4 HALOGEN / 20W / 12V

ORKJE 3

24 x E5/8 / 1,2W / 12V

3 x GU4 HALOGEN / 20W / 12V

DESIGN: JAM PAUWELS

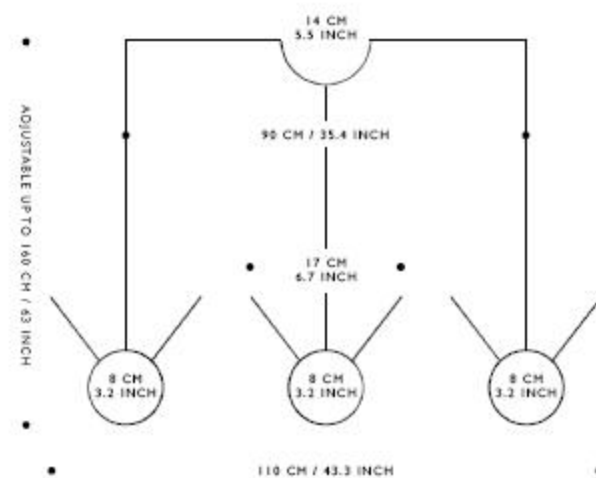
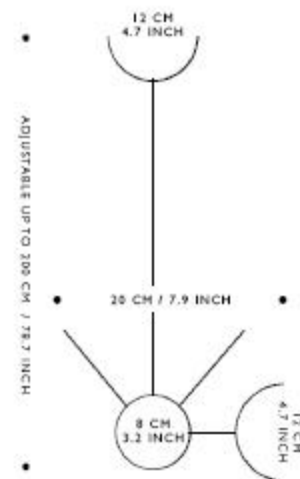

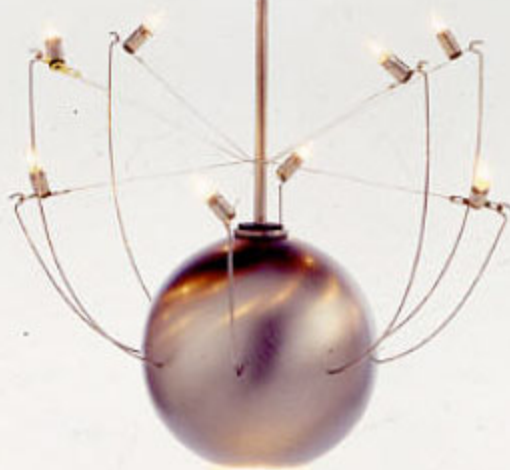
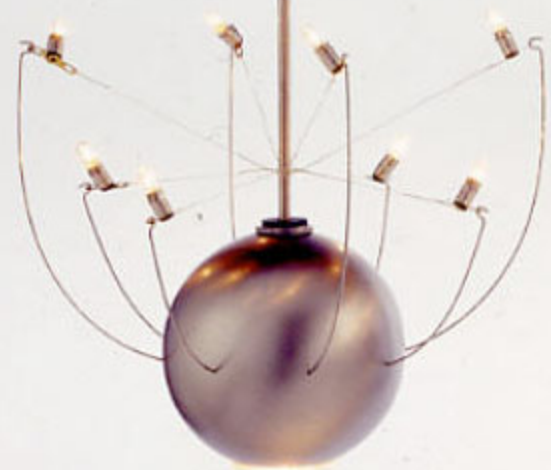

ORK GRANDE

FOCUS COLLECTION

HANGLAMP

Mat messing of mat nikkel.
Veren zijn optioneel.

HÄNGELEUCHTE

Messing mattiert oder
matt vernickelt.
Federn sind optionel.

SUSPENDED LAMP

Brass deadened or nickel deadened.
Feathers are optional.

SUSPENSION

Laiton mat ou nickel mat.
Plumes sur demande.

18 x E5/B / 1,2W / 12V

1 x GU 5,3 ALU-HALOGEN / 35W / 12V

DESIGN: JAN PAUWELS

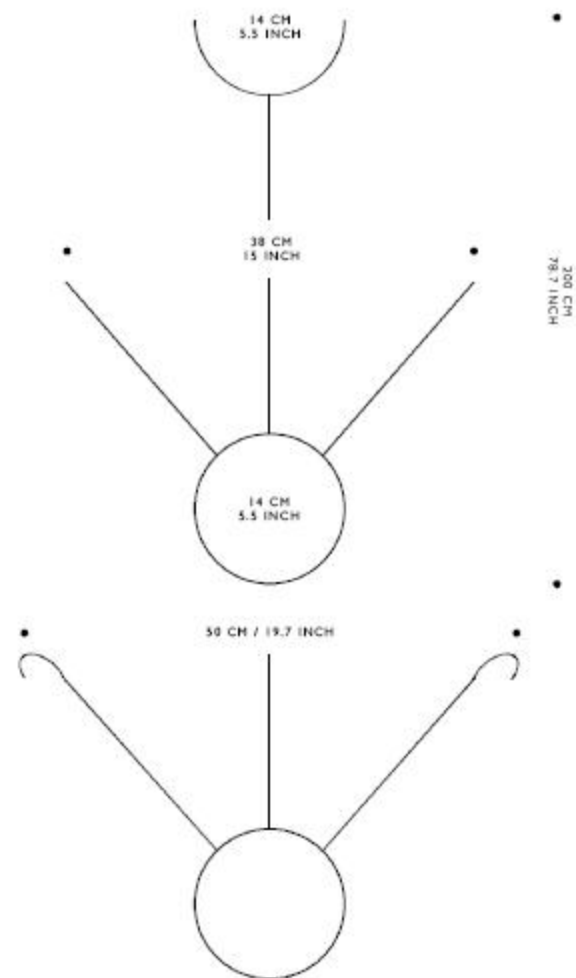





PAPYRUS

FOCUS COLLECTION

VLOERLAMP

Gevlamd rood koper of
nikkel. Voet natuursteen.
Met dimmer.

STEHLEUCHTE

Geflammtes Kupfer oder
Nickel. Fuss Naturstein.
Mit Dimmer.

FLOORLAMP

Flamed copper or nickel.
On a polished natural stone.
With dimmer.

LAMP DE SOL

Cuivre couleur de feu ou nickel.
Pierre de taille adoucie.
Avec variateur.

9 x G4 HALOGEN / 10W / 12V

DESIGN: JAM PAUWELS

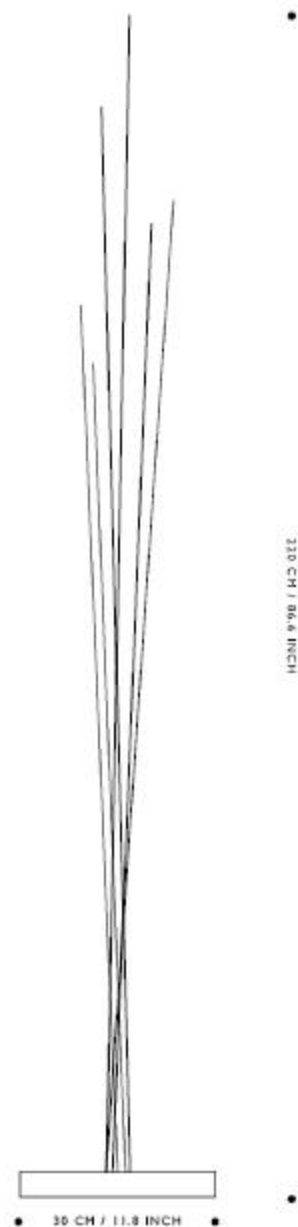



UNIVERSE

FOCUS COLLECTION

HANGLAMP

Messing of nickel.

HÄNGELEUCHTE

Messing oder Nickel.

SUSPENDED LAMP

Brass or nickel.

SUSPENSION

Laiton ou nickel.

MEDIUM 35 X E10 / 3W

GRANDE 50 X E10 / 3W

DESIGN: JAM PAUWELS

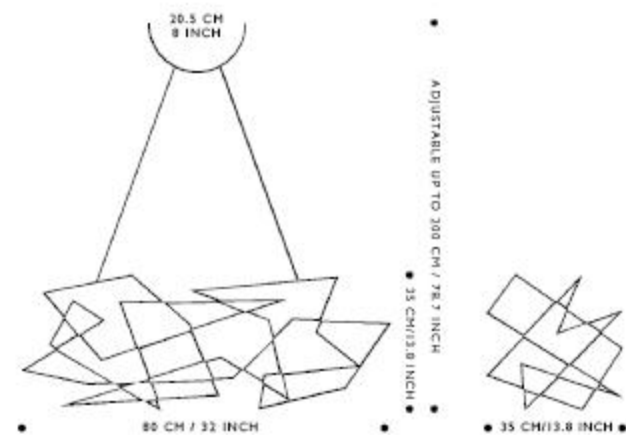
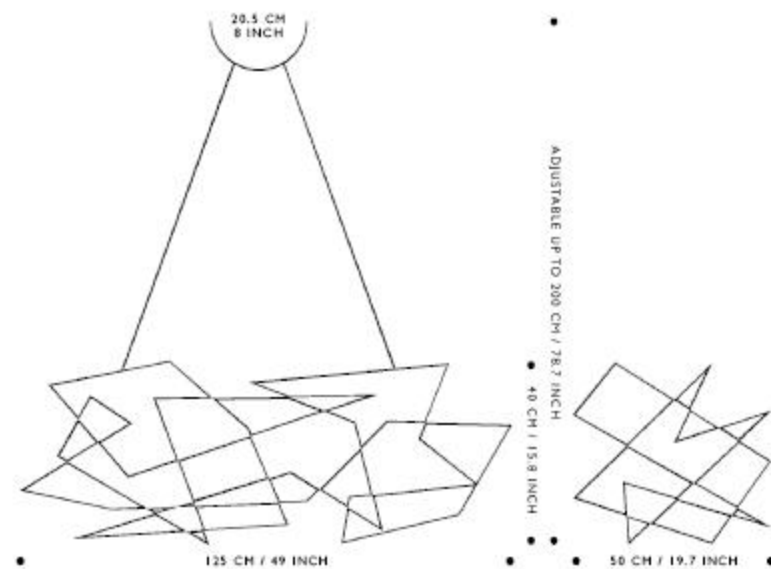

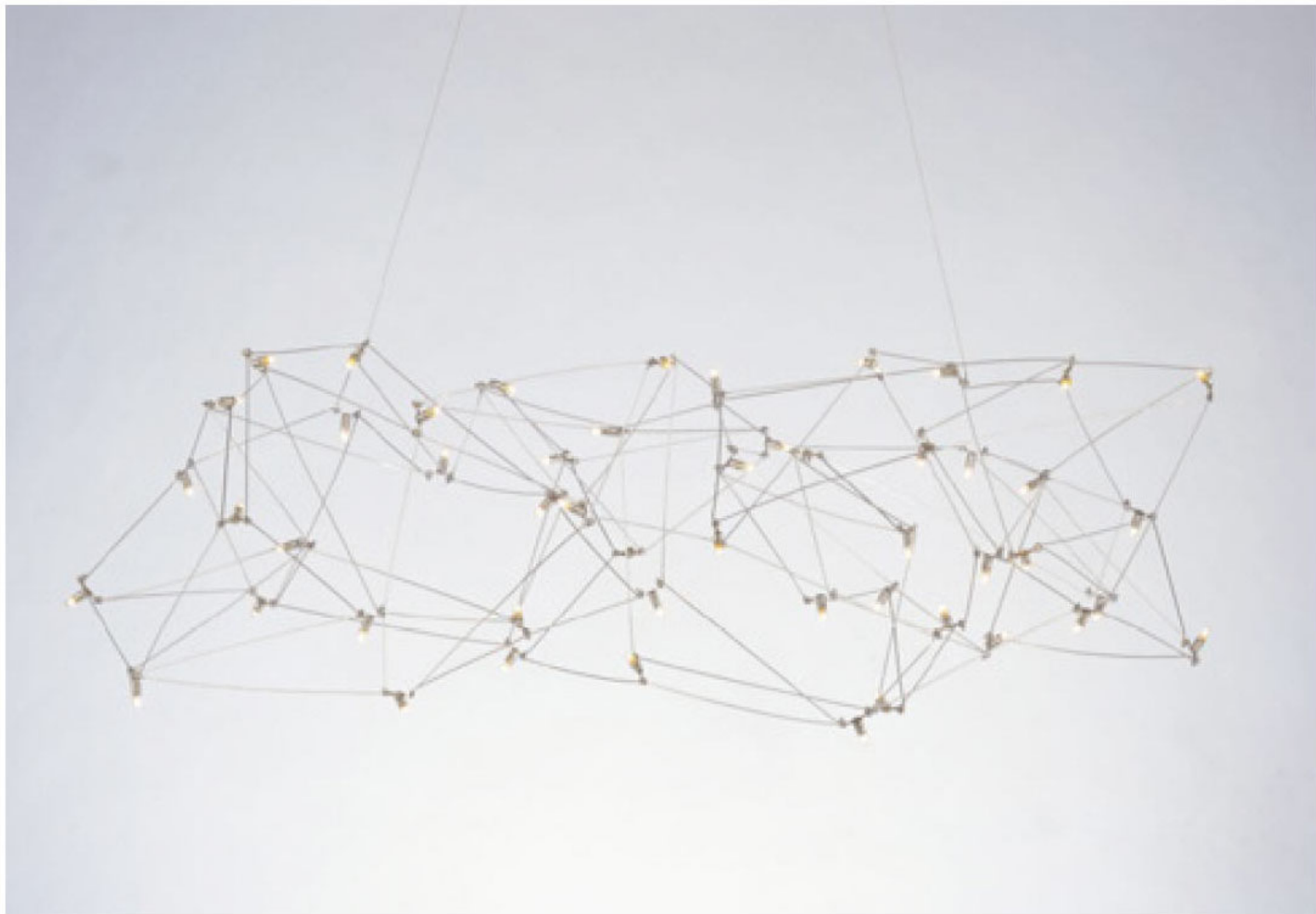

UNIVERSE SQUARE

FOCUS COLLECTION

HANGLAMP

Messing of nickel.

HÄNGELEUCHTE

Messing oder Nickel.

SUSPENDED LAMP

Brass or nickel.

SUSPENSION

Laiton ou nickel.

DOUBLE - 96 X E10 / 1,2W

TRIPLE - 128 X E10 / 1,2W

DESIGN: JAM PAUWELS

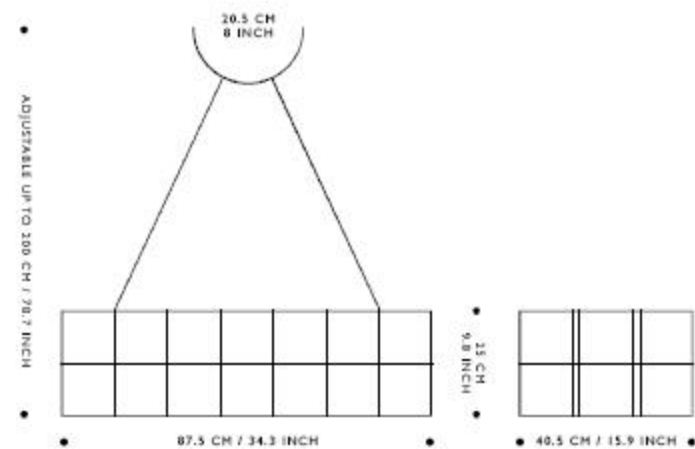
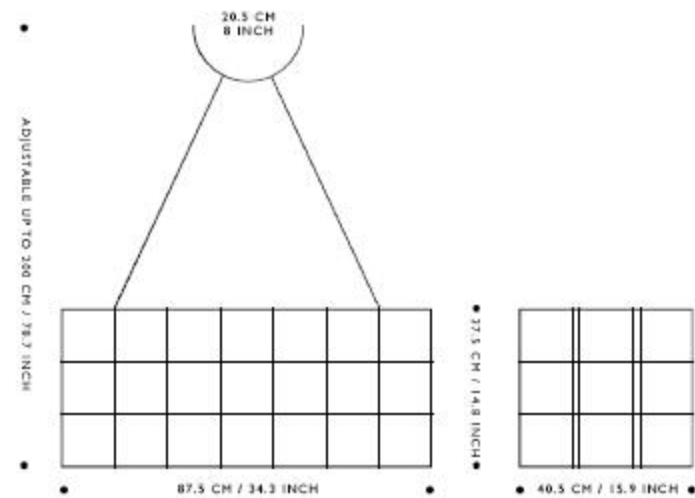
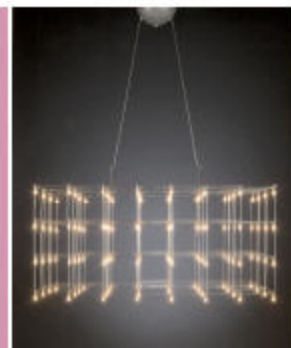



...KAN HIJ OOK SMALLER?...KAN HIJ OOK BREDER?...KAN HIJ OOK GROTER?...KAN HIJ OOK KLEINER?
...KAN HIJ OOK IN HET ZILVER?...GOUD?...OOK RVS?...BRONS?...MESSING?...KAN HIJ OOK AAN
EEN DRAAD HANGEN?...KAN HIJ OOK GEBRACHT WORDEN?...EN GEHAALD?...KAN HIJ OOK IN
ANDERE KLEUREN?...ROOD?...DOEN JULLIE DIT AL LANG?...VERZINNEN JULLIE ALLES
ZELF?...KAN HIJ OOK AAN?...KAN HIJ OOK UIT?...

***J* A !**

QUASAR
H O L L A N D

Q U A S A R H O L L A N D

B U R G S T R A A T 2

4 2 8 3 G G G I E S S E N

T H E N E T H E R L A N D S

T + 3 1 (0) 1 8 3 4 4 7 8 8 7

F + 3 1 (0) 1 8 3 4 4 8 3 3 7

E E X P O R T @ Q U A S A R . N L

W W W . Q U A S A R . N L

ARTDIRECTION+DESIGN: 94 OVERKANT-TOM BOUMAN/INGE SCHAAP

FOTOGRAFIE: GERRIT BUYS

FOTOGRAFIE P.008-009 HUGO THOMASSEN, P.094 PEER V/D KRUIS, STUDIO 47A