



D8



ZANEEN

DECORATIVE

D8 Catalogs

Table of Contents

Volume	Publication
1.3	D8 Supplement - Chandeliers
1.2	D8 Supplement - Summer 2008
1.1	D8 Supplement - 2008
1.0	D8 General Catalog

NEW

1.3

D8



ZANEEN

DECORATIVE



AGAVE
4



LOUVRE
44



IBIS
16



MOMA
50



BRERA
20



PUŠKIN
56



D'ORSAY
26



TATE
62



GUGGENHEIM
32



UFFIZI
70



HERMITAGE
38

DIEGO CHILÒ 2009

AGAVE

REGISTERED DESIGN

IN ANY ENVIRONMENT IN WHICH
LIGHT REQUIRES HARMONY
AND SMOOTH ELEGANCE,
AGAVE IMPOSES ITSELF WITH A
NOTE OF SUPERIOR CLASS.







AGAVE

THE HIGH DEFINITION OF THE
DESIGN UNITED TO THE
PERFECT ATTENTION TO DETAIL
RESULTS IN A PRODUCT OF
SUBLIME QUALITY.









AGAVE

THE HARMONIOUS DESIGN OF EACH SINGLE ELEMENT GIVES THE PRODUCT AN ALLURE DUE TO THE ABSOLUTE EQUILIBRIUM OF ITS PROPORTIONS.



AGAVE

DIEGO CHILÒ 2009

REGISTERED DESIGN

WHITE

SUSPENSIONS, CEILING,
WALL LAMPS IN PIECES OF
WHITE PAINTED METAL.
MAT GLASS.

AVAILABLE IN:
COMPACT FLUORESCENT
METAL HALIDE

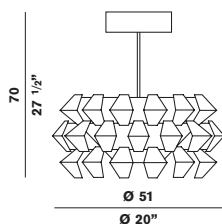

D8-1178

WHITE

MAX 1x250W E26 

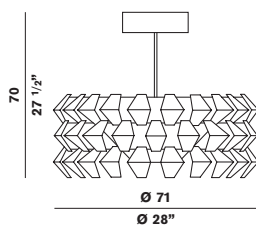

D8-1179

WHITE

MAX 3x150W E26 

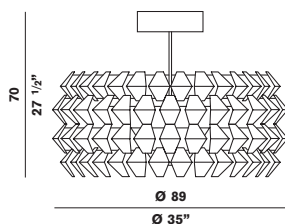

D8-1180

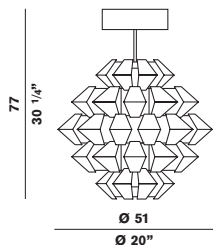

WHITE

MAX 3x150W E26 



D8-1181

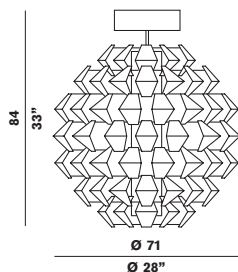

WHITE

MAX 1x250W E26 
+ 75W HI SPOT GU10 



D8-1182

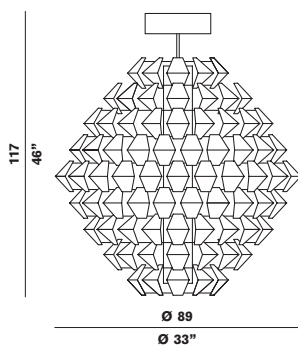

WHITE

MAX 4x150W E26 
+ 75W HI SPOT GU10 



D8-1183

WHITE

MAX 6x150W E26 
+ 75W HI SPOT GU10 

ZANEEN LIGHTING
TEL. 1.800.388.3382
FAX 416.247.9319
E-MAIL: zaneen@zaneen.com

WHITE

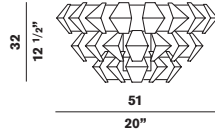

D8-2098
WHITE
MAX 1x250W E26 

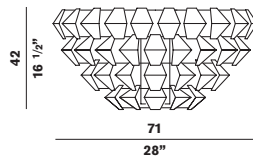

D8-2099
WHITE
MAX 3x150W E26 

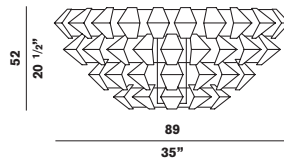

D8-2100
WHITE
MAX 3x150W E26 

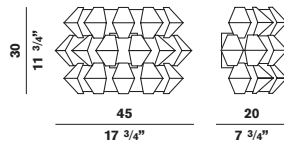

D8-3146
WHITE
MAX 2x150W E26 



DIEGO CHILÒ 2009

IBIS

REGISTERED DESIGN

BEGINNING WITH AN IDEA,
PATIENTLY SHAPING THE
OBJECT TO REACH THE
ESSENCE OF STYLE.





IBIS

ENZO PANZERI 2006

REGISTERED DESIGN

CHROME

IBIS

BLACK BLOWN GLASS
SUSPENSION AND
TRANSPARENT GRINDED
CRYSTAL DIFFUSER OR
WHITE BLOWN GLASS
SUSPENSION AND MAT
GRINDED CRYSTAL DIFFUSER.
CHROMED FITTING.

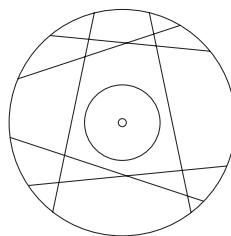
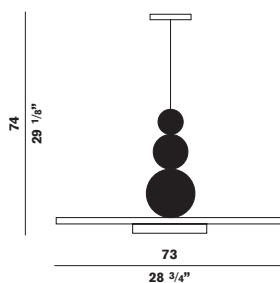

D8-1186
BLACK
MAX 3x60W G9 

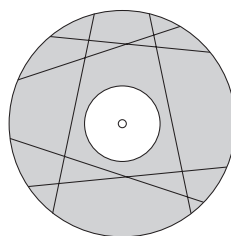
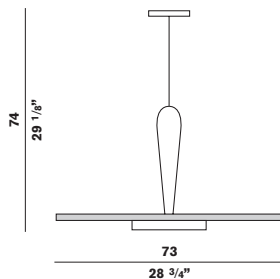

D8-1187
WHITE
MAX 3x60W G9 

ZANEEN LIGHTING
TEL. 1.800.388.3382
FAX 416.247.9319
E-MAIL: zaneen@zaneen.com



BRERA









BRERA

CHROME

WHITE BLACK RED AMBER CRYSTAL



BRERA

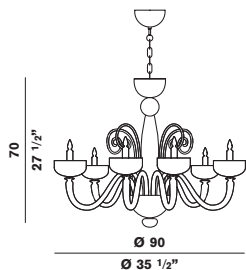

D8-1262
WHITE
MAX 6x60W G9

D8-1263
BLACK
D8-1264
RED
D8-1265
AMBER
D8-1266
CRYSTAL

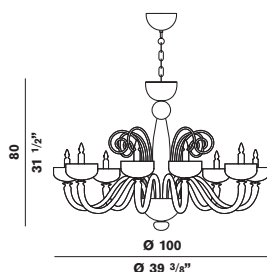

D8-1267
WHITE
MAX 8x60W G9

D8-1268
BLACK
D8-1269
RED
D8-1270
AMBER
D8-1271
CRYSTAL

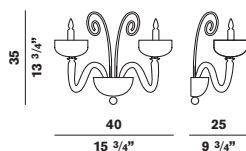

D8-3189
WHITE
MAX 2x60W G9

D8-3190
BLACK
D8-3191
RED
D8-3192
AMBER
D8-3193
CRYSTAL



WHITE



CRYSTAL



CEILING HOOK



D'ORSAY









D'ORSAY

CHROME

WHITE

BLACK

RED

AMBER

CRYSTAL



D'ORSAY

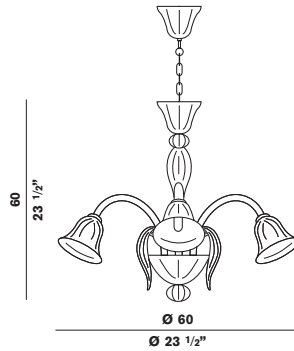

D8-1272
WHITE
MAX 3x60W G9

- D8-1273**
BLACK
- D8-1274**
RED
- D8-1275**
AMBER
- D8-1276**
CRYSTAL

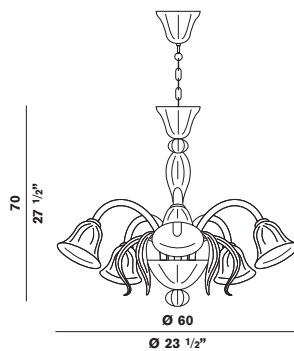

D8-1277
WHITE
MAX 5x60W G9

- D8-1278**
BLACK
- D8-1279**
RED
- D8-1280**
AMBER
- D8-1281**
CRYSTAL

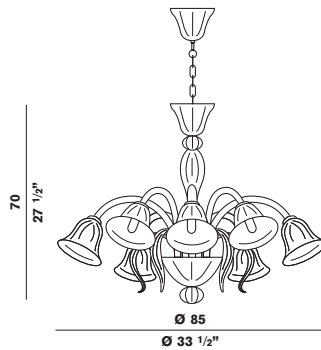

D8-1282
WHITE
MAX 8x60W G9

- D8-1283**
BLACK
- D8-1284**
RED
- D8-1285**
AMBER
- D8-1286**
CRYSTAL

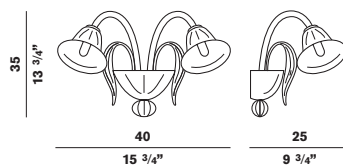

D8-3194
WHITE
MAX 2x60W G9

- D8-3195**
BLACK
- D8-3196**
RED
- D8-3197**
AMBER
- D8-3198**
CRYSTAL

ZANEEN LIGHTING
TEL. 1.800.388.3382
FAX 416.247.9319
E-MAIL: zaneen@zaneen.com



WHITE

CEILING HOOK



SILVIA POMA 2009

GUGGENHEIM

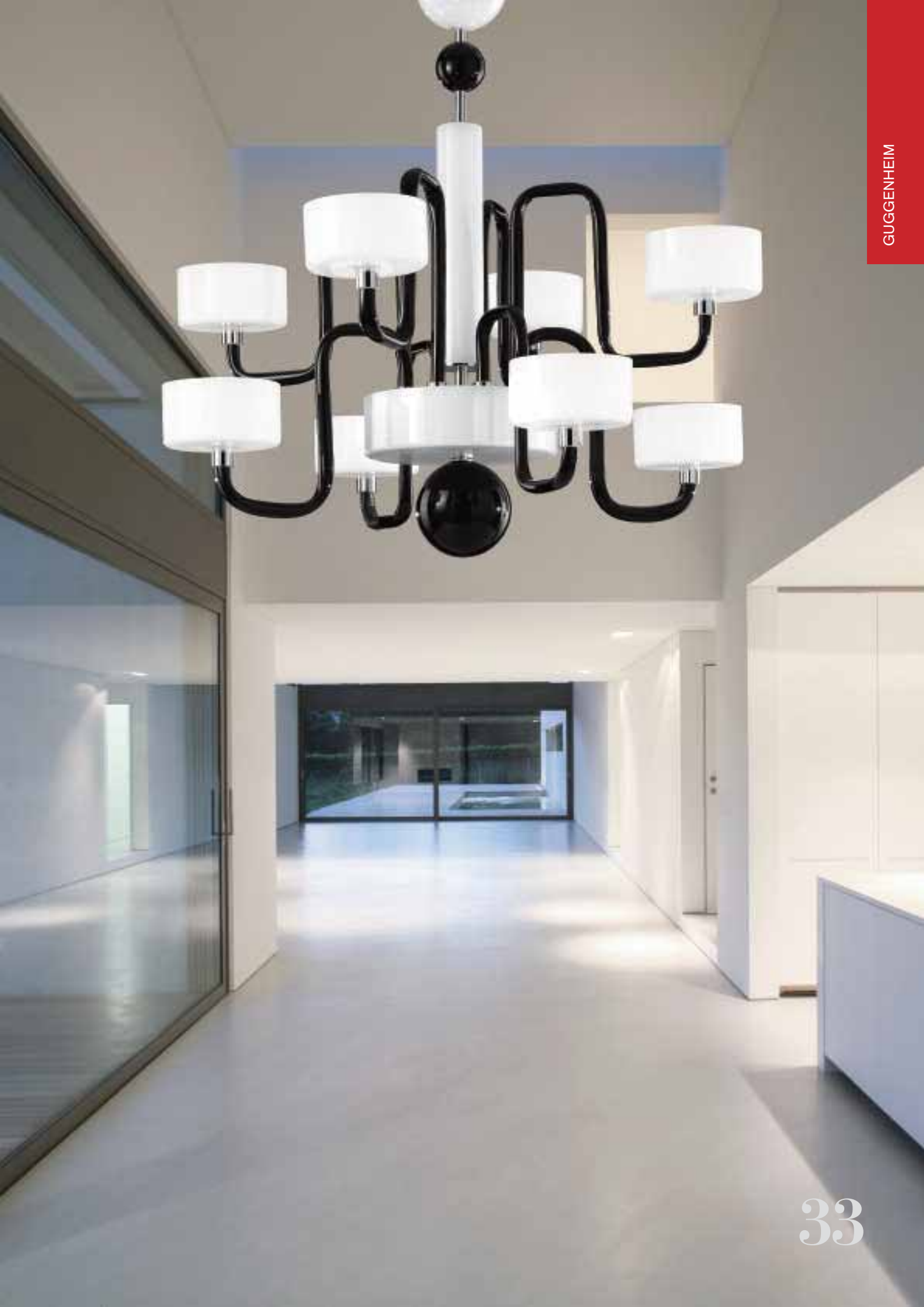

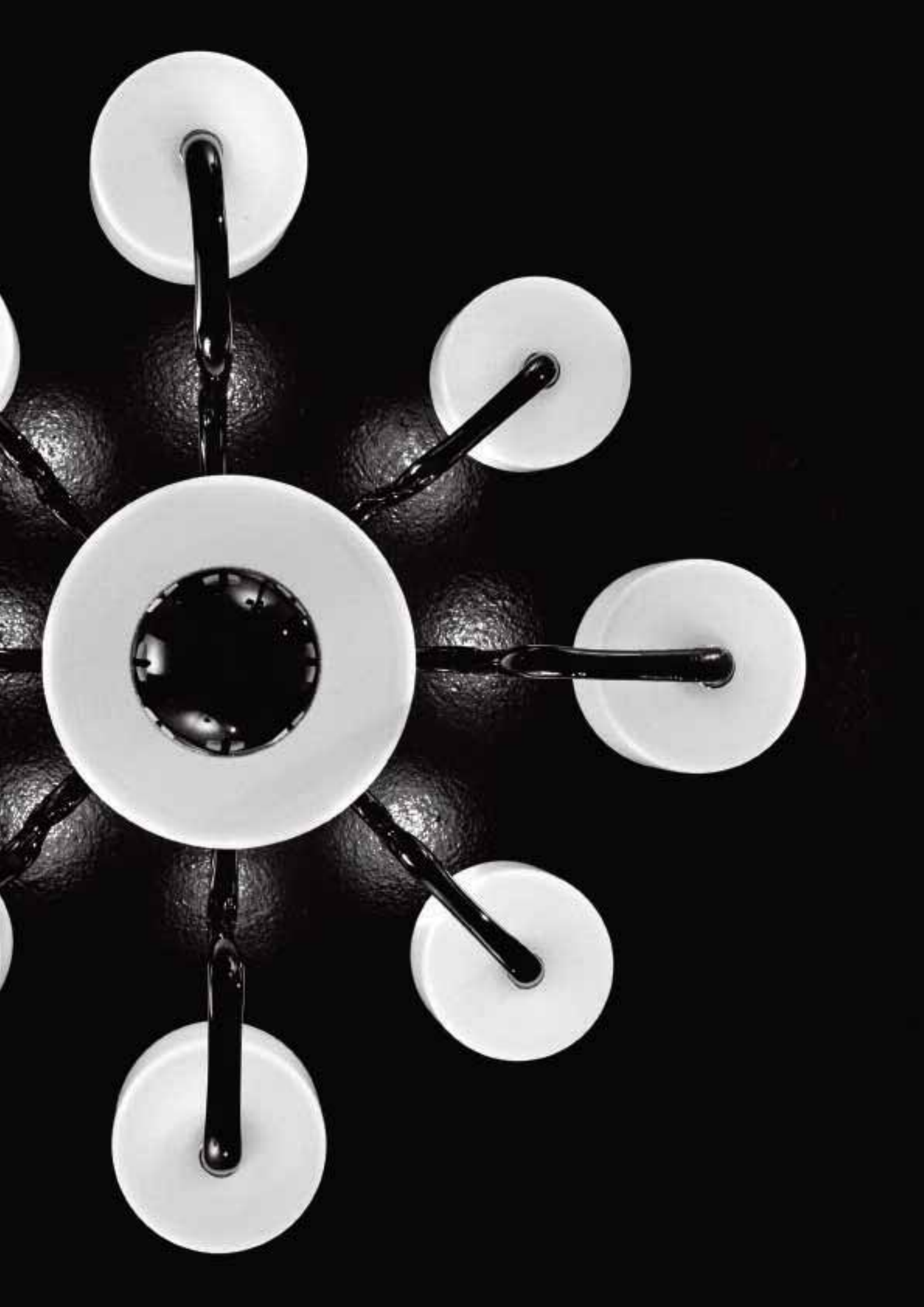





GUGGENHEIM

SILVIA POMA 2009

CHROME

WHITE/BLACK



GUGGENHEIM

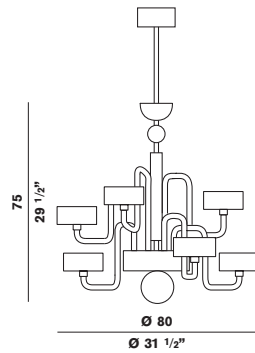

D8-1287
WHITE/BLACK
MAX 6x60W G9

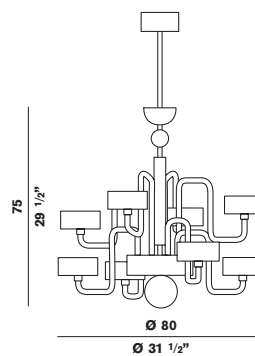

D8-1288
WHITE/BLACK
MAX 8x60W G9

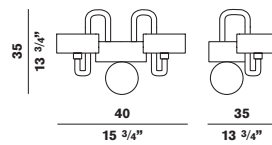

D8-3199
WHITE/BLACK
MAX 2x60W G9

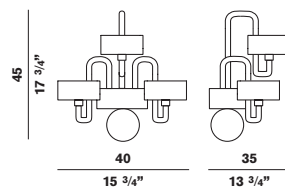

D8-3200
WHITE/BLACK
MAX 3x60W G9



CEILING HOOK

ZANEEN LIGHTING
TEL. 1.800.388.3382
FAX 416.247.9319
E-MAIL: zaneen@zaneen.com



HERMITAGE

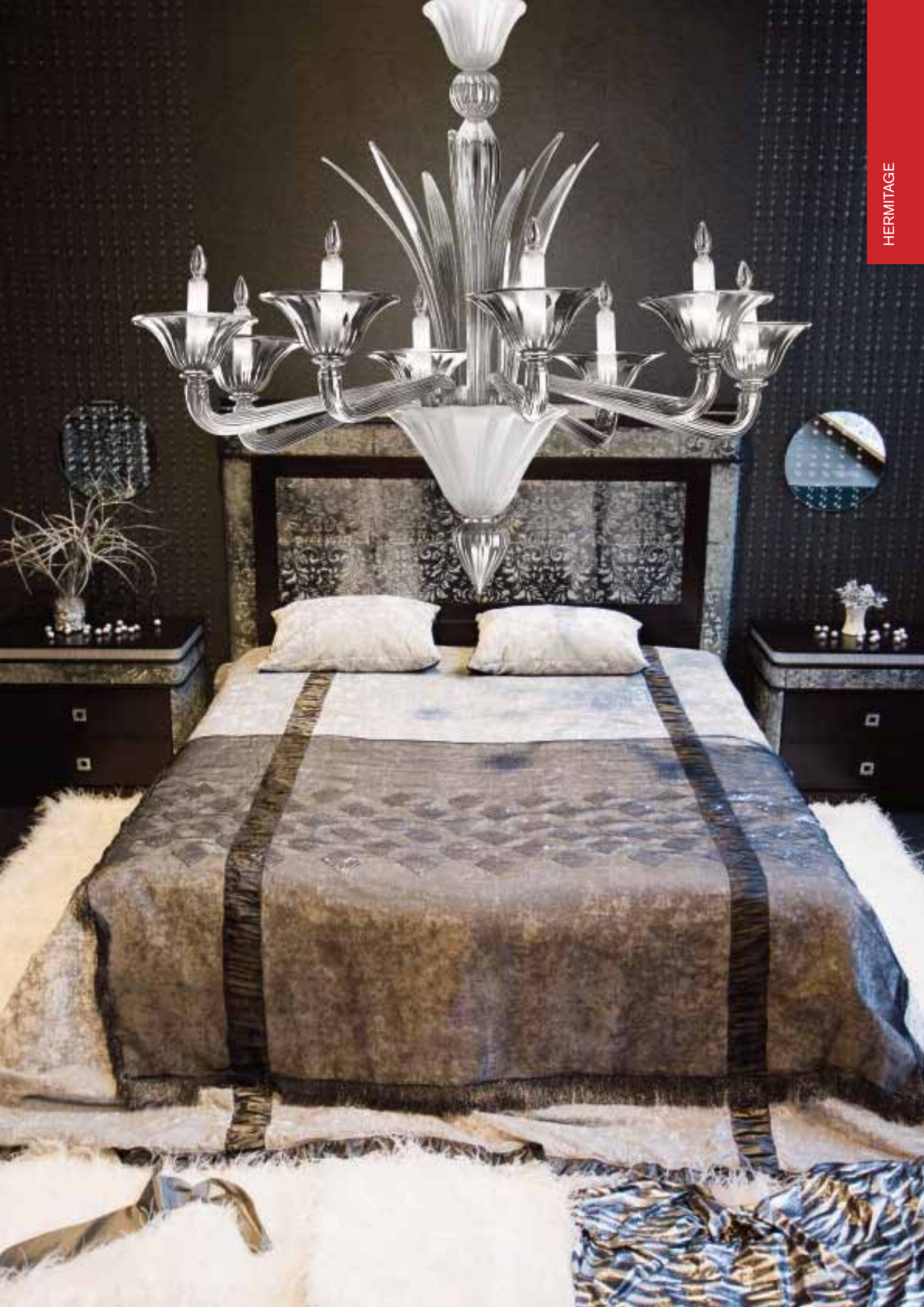







HERMITAGE

CHROME

WHITE

BLACK

RED

AMBER

CRYSTAL



HERMITAGE

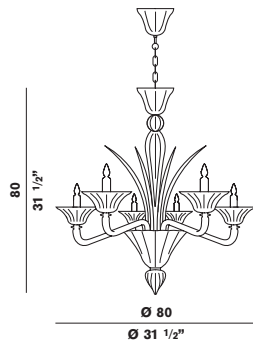

D8-1289
WHITE
MAX 6x60W G9

- D8-1290**
BLACK
- D8-1291**
RED
- D8-1292**
AMBER
- D8-1293**
CRYSTAL

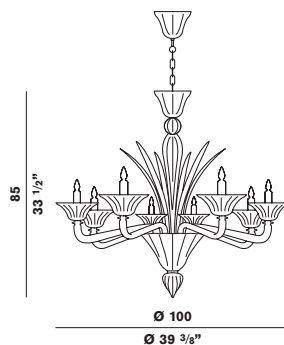

D8-1294
WHITE
MAX 8x60W G9

- D8-1295**
BLACK
- D8-1296**
RED
- D8-1297**
AMBER
- D8-1298**
CRYSTAL

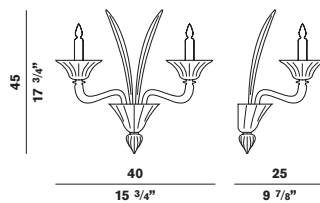

D8-3201
WHITE
MAX 2x60W G9

- D8-3202**
BLACK
- D8-3203**
RED
- D8-3204**
AMBER
- D8-3205**
CRYSTAL



WHITE



CRYSTAL



CEILING HOOK



LOUVRE









LOUVRE

CHROME

WHITE

BLACK

RED

AMBER

CRYSTAL



LOUVRE

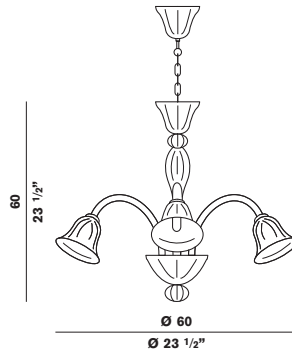

D8-1299
WHITE
MAX 3x60W G9

- D8-1300**
BLACK
- D8-1301**
RED
- D8-1302**
AMBER
- D8-1303**
CRYSTAL

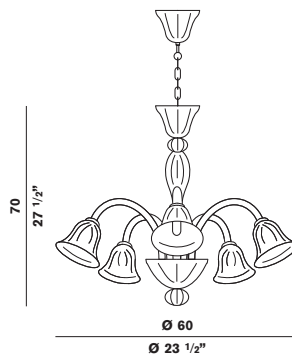

D8-1304
WHITE
MAX 5x60W G9

- D8-1305**
BLACK
- D8-1306**
RED
- D8-1307**
AMBER
- D8-1308**
CRYSTAL

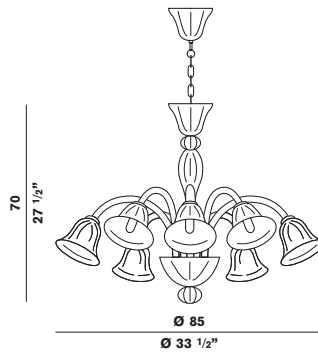

D8-1309
WHITE
MAX 8x60W G9

- D8-1310**
BLACK
- D8-1311**
RED
- D8-1312**
AMBER
- D8-1313**
CRYSTAL

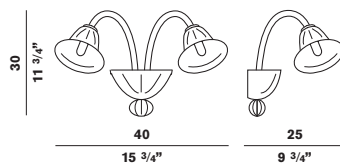

D8-3206
WHITE
MAX 2x60W G9

- D8-3207**
BLACK
- D8-3208**
RED
- D8-3209**
AMBER
- D8-3210**
CRYSTAL



WHITE



CEILING HOOK

ZANEEN LIGHTING
TEL. 1.800.388.3382
FAX 416.247.9319
E-MAIL: zaneen@zaneen.com



MOMA









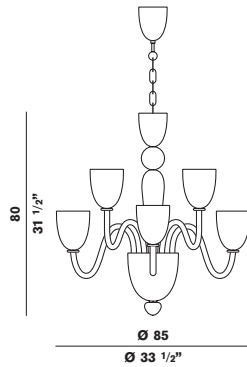

D8-1314
WHITE
MAX 6x60W G9

D8-1315
BLACK

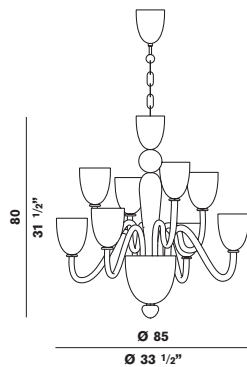

D8-1316
WHITE
MAX 8x60W G9

D8-1317
BLACK

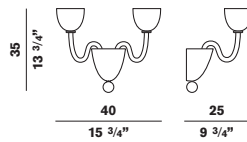

D8-3211
WHITE
MAX 2x60W G9

D8-3212
BLACK

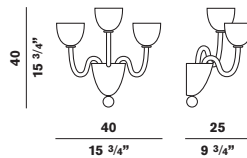

D8-3213
WHITE
MAX 3x60W G9

D8-3214
BLACK



WHITE



CEILING HOOK



PUŠKIN









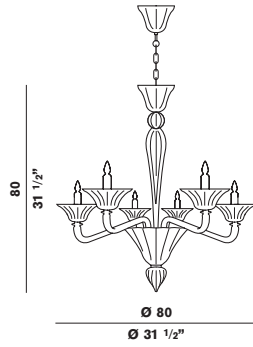

D8-1318
WHITE
MAX 6x60W G9

- D8-1319**
BLACK
- D8-1320**
RED
- D8-1321**
AMBER
- D8-1322**
CRYSTAL

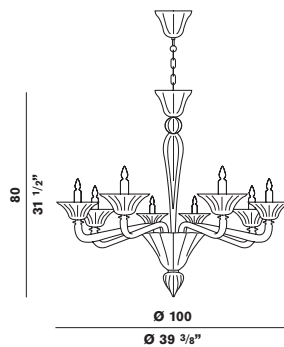

D8-1323
WHITE
MAX 8x60W G9

- D8-1324**
BLACK
- D8-1325**
RED
- D8-1326**
AMBER
- D8-1327**
CRYSTAL

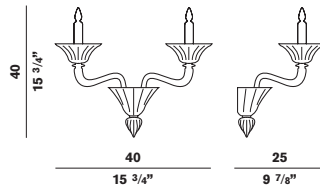

D8-3215
WHITE
MAX 2x60W G9

- D8-3216**
BLACK
- D8-3217**
RED
- D8-3218**
AMBER
- D8-3219**
CRYSTAL



WHITE



CRYSTAL



CEILING HOOK



TATE













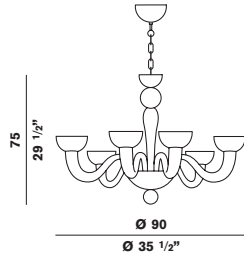

D8-1328
WHITE
MAX 6x60W G9

D8-1329
BLACK

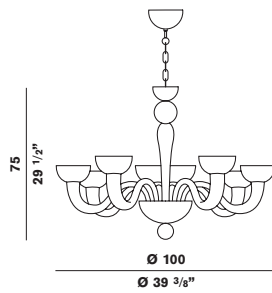

D8-1330
WHITE
MAX 8x60W G9

D8-1331
BLACK

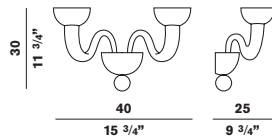

D8-3220
WHITE
MAX 2x60W G9

D8-3221
BLACK



WHITE



CEILING HOOK



UFFIZI



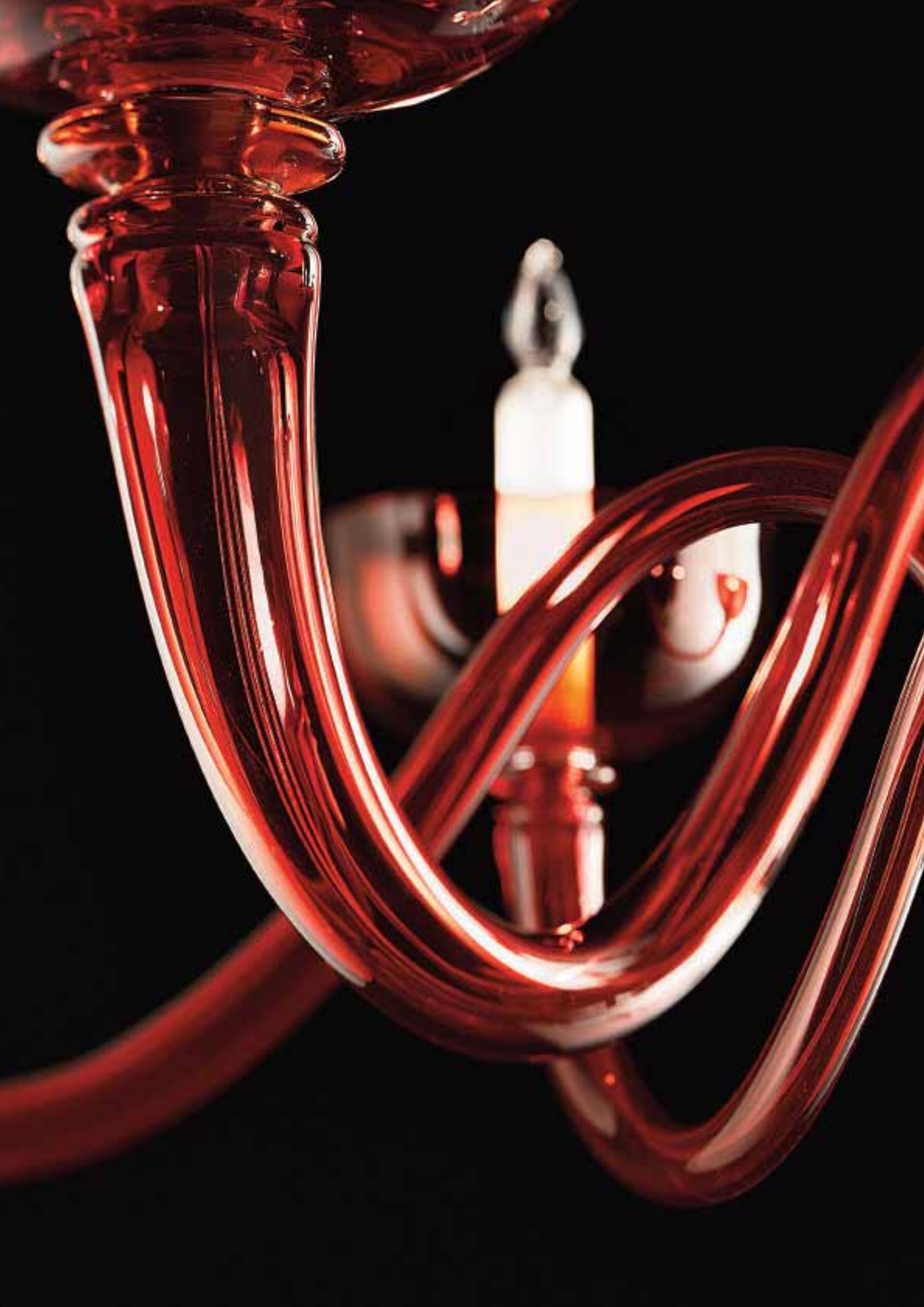



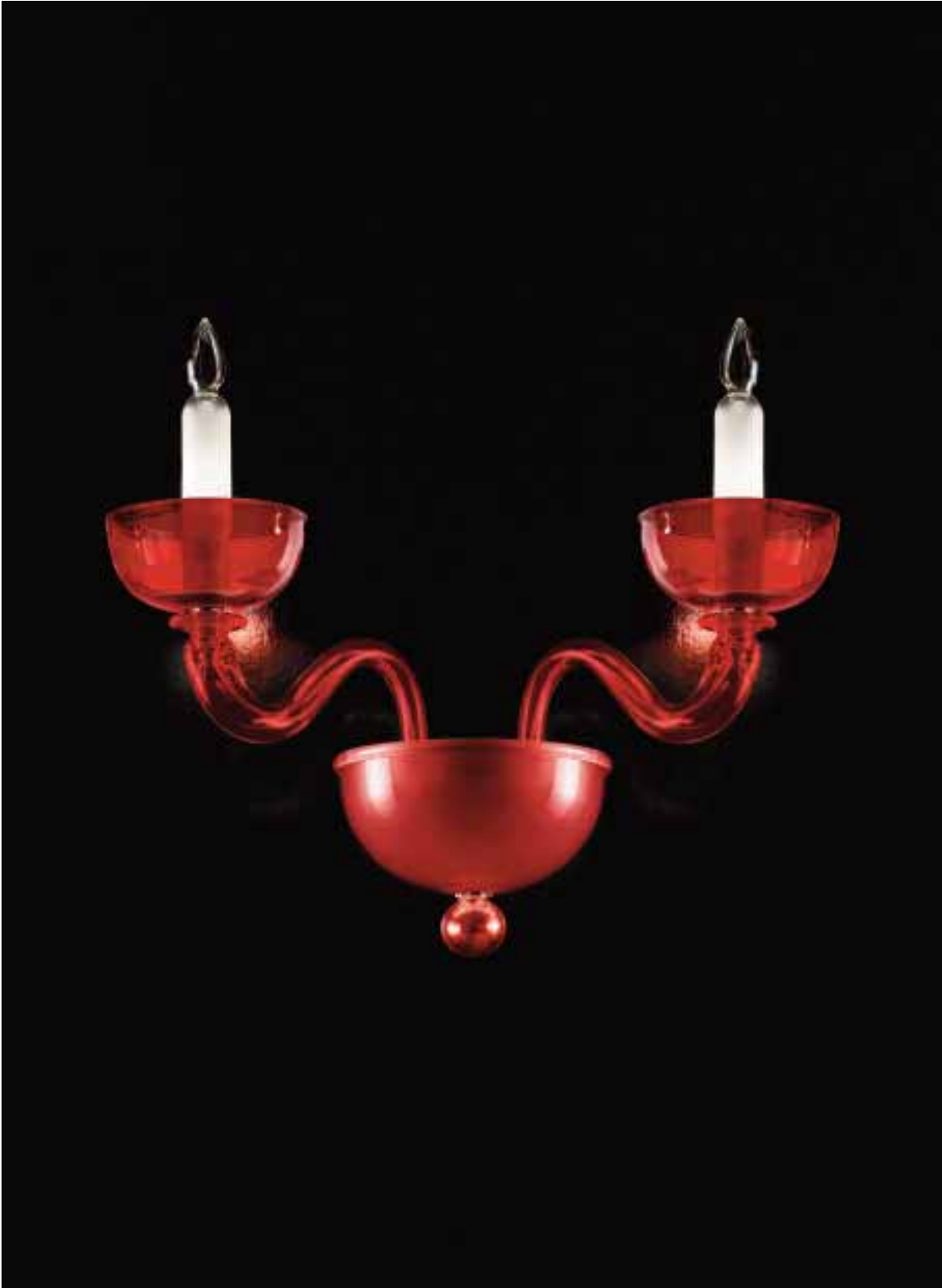

CHROME

WHITE

BLACK

RED

AMBER

CRYSTAL

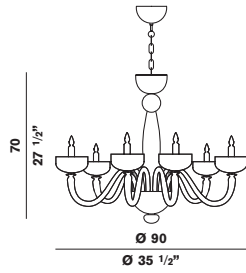

D8-1332
WHITE
MAX 6x60W G9

- D8-1333**
BLACK
- D8-1334**
RED
- D8-1335**
AMBER
- D8-1336**
CRYSTAL

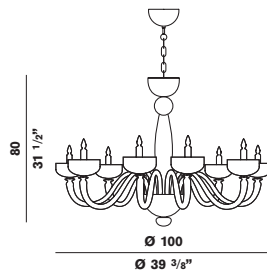

D8-1337
WHITE
MAX 8x60W G9

- D8-1338**
BLACK
- D8-1339**
RED
- D8-1340**
AMBER
- D8-1341**
CRYSTAL

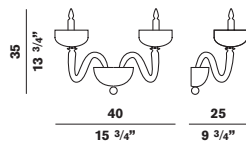

D8-3222
WHITE
MAX 2x60W G9

- D8-3223**
BLACK
- D8-3224**
RED
- D8-3225**
AMBER
- D8-3226**
CRYSTAL



WHITE



CRYSTAL



CEILING HOOK

INDEX

NUMERICAL ORDER

code	page	code	page	code	page
D8-1178	12	D8-1309	49	D8-3208	49
D8-1179	13	D8-1310	49	D8-3209	49
D8-1180	12	D8-1311	49	D8-3210	48
D8-1181	6	D8-1312	49	D8-3211	54
D8-1182	7	D8-1313	49	D8-3212	55
D8-1183	5	D8-1314	55	D8-3213	55
D8-1186	17,18	D8-1315	55	D8-3214	53
D8-1187	18	D8-1316	52	D8-3215	60
D8-1262	25	D8-1317	51	D8-3216	60
D8-1263	25	D8-1318	61	D8-3217	61
D8-1264	25	D8-1319	61	D8-3218	61
D8-1265	25	D8-1320	61	D8-3219	61
D8-1266	25	D8-1321	61	D8-3220	68
D8-1267	25	D8-1322	61	D8-3221	66
D8-1268	21	D8-1323	61	D8-3222	75
D8-1269	23	D8-1324	61	D8-3223	75
D8-1270	25	D8-1325	57	D8-3224	74
D8-1271	25	D8-1326	61	D8-3225	75
D8-1272	31	D8-1327	69	D8-3226	75
D8-1273	31	D8-1328	63,67	D8-9024	25,29,31,41,43,49,52 55,61,67,69,73,75
D8-1274	31	D8-1329	69	D8-9025	25,41,43,61,75
D8-1275	31	D8-1330	69	D8-9026	25,31,37,43,49,55,61,69,75
D8-1276	31	D8-1331	65		
D8-1277	31	D8-1332	75		
D8-1278	31	D8-1333	75		
D8-1279	27	D8-1334	75		
D8-1280	31	D8-1335	75		
D8-1281	29	D8-1336	75		
D8-1282	31	D8-1337	71		
D8-1283	31	D8-1338	73		
D8-1284	31	D8-1339	75		
D8-1285	31	D8-1340	75		
D8-1286	31	D8-1341	75		
D8-1287	37	D8-2098	11		
D8-1288	33,35	D8-2099	9		
D8-1289	43	D8-2100	15		
D8-1290	43	D8-3146	10		
D8-1291	43	D8-3189	25		
D8-1292	43	D8-3190	25		
D8-1293	43	D8-3191	25		
D8-1294	43	D8-3192	25		
D8-1295	41	D8-3193	24		
D8-1296	43	D8-3194	31		
D8-1297	43	D8-3195	31		
D8-1298	39	D8-3196	31		
D8-1299	49	D8-3197	30		
D8-1300	49	D8-3199	36		
D8-1301	49	D8-3200	36		
D8-1302	45	D8-3201	42		
D8-1303	49	D8-3202	43		
D8-1304	49	D8-3203	43		
D8-1305	49	D8-3204	43		
D8-1306	49	D8-3205	43		
D8-1307	49	D8-3206	49		
D8-1308	47	D8-3207	49		

AGAVE	page	4	HERMITAGE	page	38	PUŠKIN	page	56
D8-1178		12	D8-1289		43	D8-1318		61
D8-1179		13	D8-1290		43	D8-1319		61
D8-1180		12	D8-1291		43	D8-1320		61
D8-1181		6	D8-1292		43	D8-1321		61
D8-1182		7	D8-1293		43	D8-1322		61
D8-1183		5	D8-1294		43	D8-1323		61
D8-2098		11	D8-1295		41	D8-1324		61
D8-2099		9	D8-1296		43	D8-1325		57
D8-2100		15	D8-1297		43	D8-1326		61
D8-3146		10	D8-1298		39	D8-1327		59
			D8-3201		42	D8-3215		60
			D8-3202		43	D8-3216		60
			D8-3203		43	D8-3217		61
			D8-3204		43	D8-3218		61
			D8-3205		43	D8-3219		61
BRERA	page	20	IBIS	page	16	TATE	page	62
D8-1262		26	D8-1186		17,18	D8-1328		63,67
D8-1263		26	D8-1187		18	D8-1329		69
D8-1264		26				D8-1330		69
D8-1265		25	LOUVRE	page	44	D8-1331		65
D8-1266		25	D8-1299		49	D8-3220		68
D8-1267		25	D8-1300		49	D8-3221		66
D8-1268		21	D8-1301		49			
D8-1269		23	D8-1302		45	UFFIZI	page	70
D8-1270		25	D8-1303		49	D8-1332		75
D8-1271		25	D8-1304		49	D8-1333		75
D8-3189		25	D8-1305		49	D8-1334		75
D8-3190		25	D8-1306		49	D8-1335		75
D8-3191		25	D8-1307		49	D8-1336		75
D8-3192		25	D8-1308		47	D8-1337		71
D8-3193		24	D8-1309		49	D8-1338		73
			D8-1310		49	D8-1339		75
D'ORSAY	page	26	D8-1311		49	D8-1340		75
D8-1272		31	D8-1312		49	D8-1341		75
D8-1273		31	D8-1313		49	D8-3222		75
D8-1274		31	D8-3206		49	D8-3223		75
D8-1275		31	D8-3207		49	D8-3224		74
D8-1276		31	D8-3208		49	D8-3225		75
D8-1277		31	D8-3209		49	D8-3226		75
D8-1278		31	D8-3210		48			
D8-1279		27				ACCESSORIES		
D8-1280		31	MOMA	page	50	WHITE FABRIC		
D8-1281		29	D8-1314		55	D8-9024		25,29,31,41,43,49,52
D8-1282		31	D8-1315		55			55,61,67,69,73,75
D8-1283		31	D8-1316		52	CRYSTAL		
D8-1284		31	D8-1317		51	D8-9025		25,41,43,61,75
D8-1285		31	D8-3211		54	CEILING HOOK		
D8-1286		31	D8-3212		55	D8-9026		25,31,37,43,49,55,61,69,75
D8-3194		31	D8-3213		55			
D8-3195		31	D8-3214		53			
D8-3196		31						
D8-3197		30						
GUGGENHEIM	page	32						
D8-1287		37						
D8-1288		33,35						
D8-3199		36						
D8-3200		36						

BRANDS



Approved by CSA for CANADIAN & US Safety Standards.

ADA

The Americans with Disabilities Act.



Fixture meets standard EN 60598-1.



The Italian Quality Mark Institute is an official body to guarantee and check that all equipment conforms with EC norms (34-21).



Low-energy consumption bulbs can be fitted.



The fixture can be applied on surfaces normally inflammable.



Fixture class II.



Fixture class III

IP20

Index protection.

LIGHT BULBS



HALO G9



HALO E27



HALO GU10

D8

SERVING
NORTH AMERICA
SINCE 1981



ZANEEN LIGHTING
30 Tycos Drive
Toronto, Ontario
Canada M6B 1V9
T 416.247.9221
F 416.247.9319
zaneen@zaneen.com
www.zaneen.com

Made in Italy by:

 **PANZERI**[®]

NEW

1.2

D8



ZANEEN

DECORATIVE



INDEX

AFF2, RIMMEL8, TRACK16, BRI-BRI24, RING INOX34, RING40, TOY44

ENZO PANZERI 2008

AFFEF





REGISTERED DESIGN

POLISH STAINLESS STEEL

WHITE/WHITE
W/W

WHITE/BLACK
W/B

D8-1149 - W/W
D8-1150 - W/B

MAX 4x75W HI SPOT ES63GU10 
CE  IP20  

D8-1151 - RGB - W/W
D8-1152 - RGB - W/B



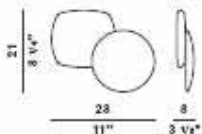
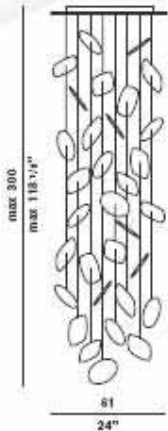
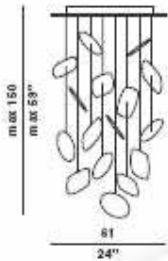

MAX 4x75W HI SPOT ES63GU10 
+ MODULO LED 3X3W RGB
+ REMOTE CONTROL
CE  IP20  

D8-1153 - W/W
D8-1154 - W/B

KIT WITH 8 H. 900CM WIRES,
16 CERAMIC ELEMENTS AND 16 FIXINGS



D8-3125 - W/W
D8-3126 - W/B

MAX 2x75W G9 
CE  IP20  





AFEF

COLOUR WITH MORE STYLE: THE LED MODEL ALLOWS TO SHINE RED, GREEN, BLUE LIGHT OR EVEN MIXED.







VALERIO BOTTIN 2008

RIMMEL

REGISTERED DESIGN

A SOFT AND WINDING LINE
REDRAWS THE CONCEPT OF
LIGHTING WITH A SPARK OF
CREATIVITY THAT CAN LIGHT
EVERY ROOM.





RIMMEL





RIMMEL

THE BALANCE DERIVES FROM A CAREFUL
FORMAL RESEARCH.





RIMMEL

VALERIO BOTTIN 2008

REGISTERED DESIGN

CHROME

SUSPENSIONS WITH
CHROMED DETAILS. WALL
LAMPS IN WHITE PAINTED
METAL. WHITE OPAL GLASSES.

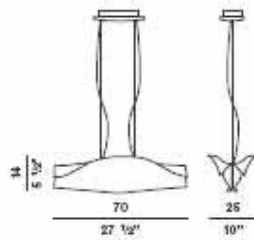

D8-1156

MAX 200W R7s

CE IP20

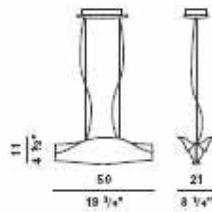

D8-1155

MAX 150W R7s 78 mm

CE IP20

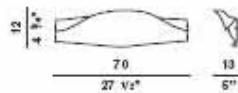

D8-3128

MAX 200W R7s

CE IP20

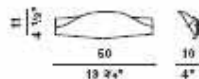

D8-3127

MAX 150W R7s 78 mm

CE IP20 600

VALERIO BOTTIN
GIAMPAOLO MENGATO 2008

TRACK

REGISTERED DESIGN

THE LIGHT OF INTUITION OPENS
NEW HORIZONS TO THE
CONTEMPORARY WAYS OF
LIVING. AN INTENSE PASSION
FOR DESIGN.

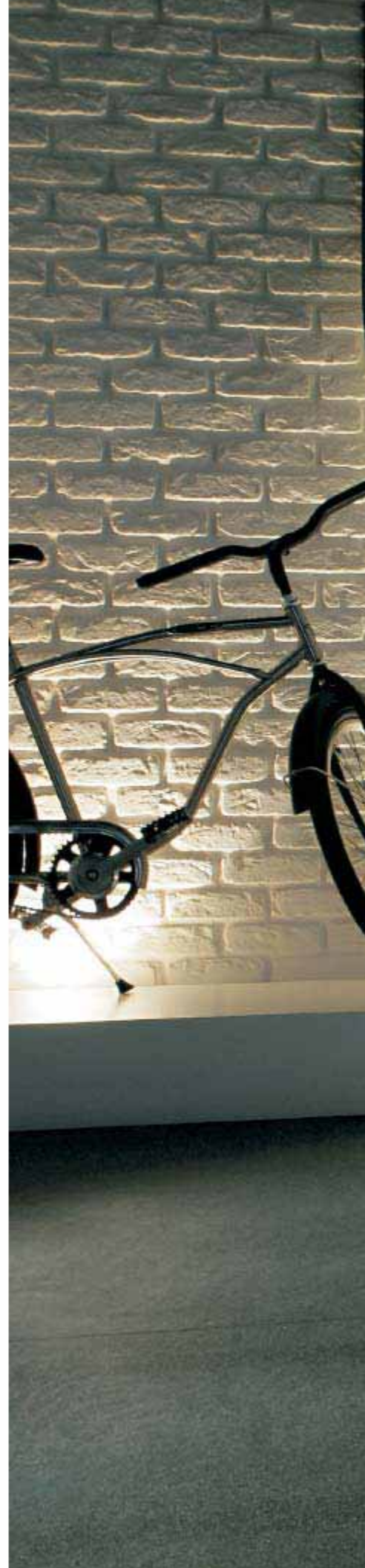







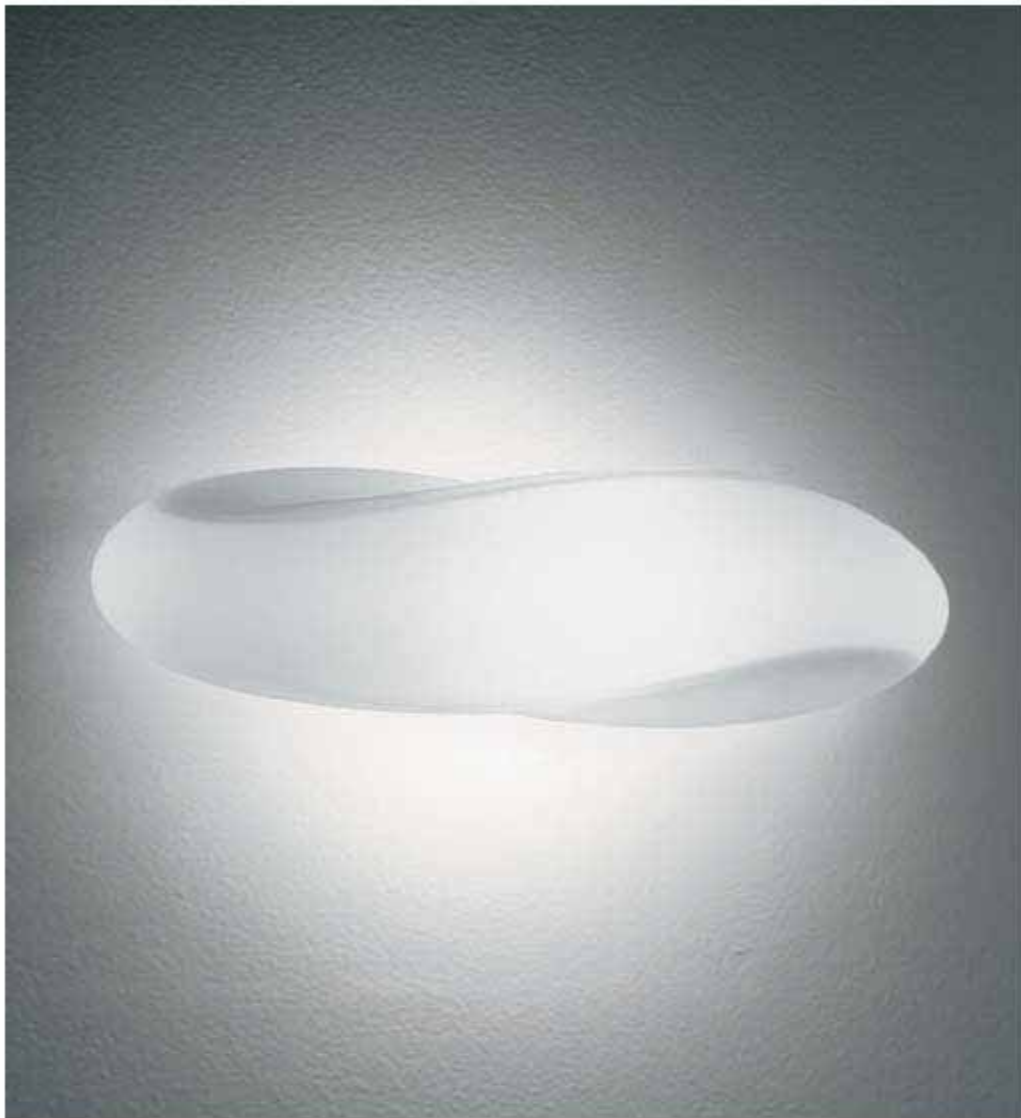

TRACK

A CLEAR AND DISTINCTLY PERSONAL STYLE
ALLOWS TO MATCH THE OBJECT TO ANY
CONTEXT.





VALERIO BOTTIN
GIAMPAOLO MENGATO 2008

REGISTERED DESIGN

FLOOR, TABLE, WALL/CEILING
AND SUSPENSION LAMP IN
METALLIZED GREY OR WHITE
METAL. BLOWN WHITE MAT
GLASS.



D8-1157
D8-1158
MAX 150W
CE IP40



D8-1159
D8-1160
MAX 150W
CE IP40

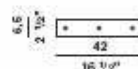

D8-1071
D8-1017

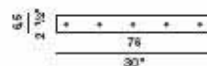

D8-1073
D8-1018

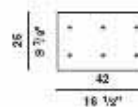

D8-1072
D8-1019

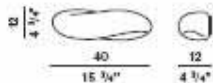

D8-2091
MAX 150W R7s 78 mm
CE IP40

CAN BE MOUNTED AS WALL/CEILING LAMP

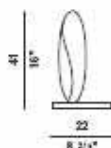

D8-4240
D8-4241
MAX 75W G9
CE IP20



D8-4242
D8-4243
MAX 150W
CE IP20

LEO DE CARLO 2008

BRI-BRI

REGISTERED DESIGN

LIGHT PRESENCES THAT GIVE TO THE ROOM AN EXCLUSIVE ATMOSPHERE, WHERE THE FREEDOM OF EXPRESSION COMBINES WITH FASHION STYLE INTUITIONS FROM OTHER TIMES.





BRI-BRI



THE ACCURATE ATTENTION FOR EVERY
DETAILS HELPS TO INCREASE THE VALUE
OF THE OBJECT.





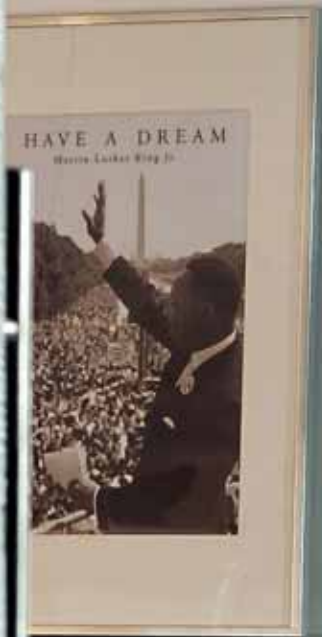

BRI-BRI



A NOTE OF SOFT AND BRIGHT IRONY
JOINS A TRUE MENTION OF THE
ESTETIC THEMES OF MODERNITY.
A VERY TOPICAL LIGHT TRANSLATION.





BRI-BRI

LEO DE CARLO 2008

REGISTERED DESIGN

CHROME

SUSPENSIONS AND WALL LAMPS IN CHROMED BRASS AND DIFFUSERS IN BLOWN TRANSPARENT GRINDED GLASS.

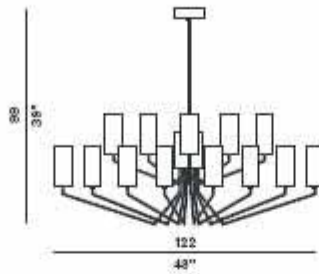

D8-1163
MAX 24x40W G9
CE IP40

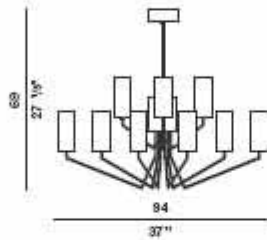
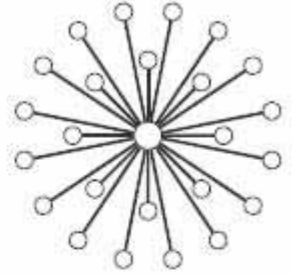

D8-1162
MAX 18x40W G9
CE IP40

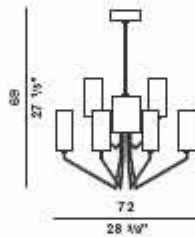
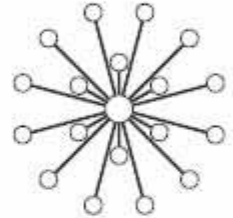

D8-1161
MAX 12x40W G9
CE IP40

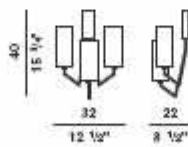
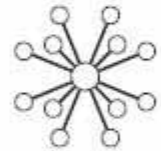

D8-3130
MAX 3x75W G9
CE IP40

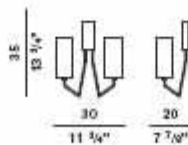

D8-3129
MAX 2x75W G9
CE IP40

SILVIA POMA 2008

RING INOX

REGISTERED DESIGN

IN THE HARMONIC COMBINATION OF THE ELEMENTS, IN THE SPARKLING METAL SHINES A SOBER AND AT THE SAME TIME INNOVATIVE DESIGN CONCEPTION.







RING INOX

LIGHTS THAT MARK THE ROOM AND
BRING OUT ITS PECULIAR UNIQUENESS
WITH THE SPARK OF STYLE.





SUSPENSIONS, WALL,
CEILING, TABLE LAMP IN
POLISHED STAINLESS STEEL.

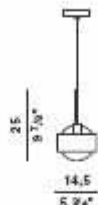

D8-1174
MAX 60W G9
CE IP40

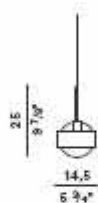

D8-1175
MAX 60W G9
CE IP40

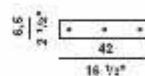

D8-1071
D8-1017

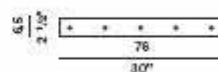

D8-1073
D8-1018

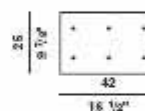

D8-1072
D8-1019

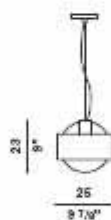

D8-1176
MAX 100W E27 Ø 80 mm
CE IP20

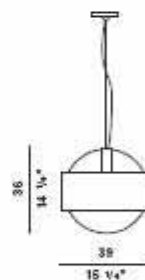

D8-1177
MAX 150W E27
CE IP20

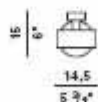

D8-2097
MAX 60W G9
CE IP40



D8-3136
MAX 60W G9
CE IP40

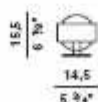

D8-4249
MAX 60W G9
CE IP20



SILVIA POMA 2007-2008

RING

REGISTERED DESIGN

THE SPIRIT OF A FREE CREATIVITY
OFFERS NEW ACCENTS OF STYLE.
THANKS TO A SPARKLING
MEASURED IRONY THAT LIGHTS
THE SPACE WITH BRILLIANTS LINES
AND ACTUALS COLOURS.





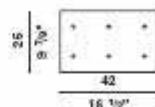
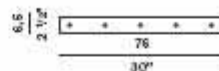
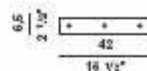
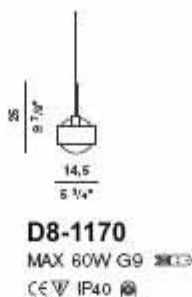
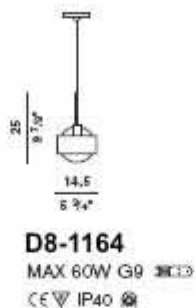

SUSPENSIONS, WALL, CEILING, TABLE, FLOOR LAMP IN BLOWN GLASS AND CHROMED METAL

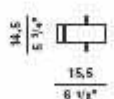
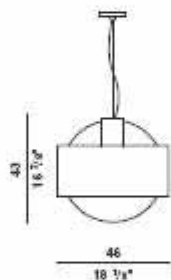
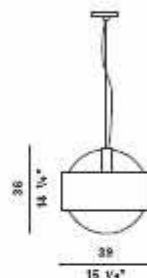
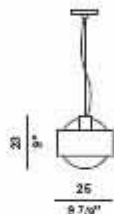

HIGHLIGHT 2007

TOY

EXPERIENCE AND PASSION,
FUSED IN COMPLETE HARMONY,
TURN INTO OBJECTS THAT
REDRAW WITH INTELLIGENCE
THE DIMENSION OF LIVING.











TOY

HIGHLIGHT 2007

WHITE

POLISHED STAINLESS STEEL

MAT STAINLESS STEEL

WALL LAMPS IN POLISHED OR
MAT STAINLESS STEEL OR IN
WHITE PAINTED METAL.
DIFFUSERS IN MAT GLASS.

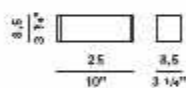

D8-3137

D8-3138

D8-3139

MAX 1x26W G24Q-3

CE IP40

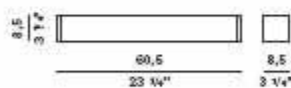

D8-3140

D8-3141

D8-3142

MAX 1x80W 2G11

CE IP40

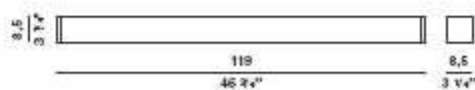

D8-3143

D8-3144

D8-3145

MAX 2x54W G5

CE IP40

NEW

1.1

D8



ZANEEN

DECORATIVE



LIGHTING-DESIGN

LUMIERE-DESIGN

LUZ-DESIGN

INDEX

FLORAL**4**, RING**18**, TOURBILLON**22**, DOMINO INOX**40**, DOMINO**46**, FLAN**50**, WILLY 100**54**, ALL STARS**58**, SNAKE**62**, CARRÈ PELLE**66**, DEBUT**70**, OFFSET**74**, LIGHTS BULBS**75**, BRANDS **76**, ACCESSORY**77**, INDEX**78**

HIROKI TAKADA 2007

FLORAL

NEW AESTHETIC INTUITIONS
GIVE TO THE AMBIENT A SPARK
OF FRESH AND UNUSUAL
ORIGINALITY, AS SIGN OF A
SUTTLE AND LIVELY IRONY.

DE NOUVELLES PERCEPTIONS
ESTHÉTIQUES DONNENT À LA
PIÈCE UN TOUCHE DE FRAÎCHE
ET INHABITUELLE ORIGINALITÉ,
SOUS LE SIGNE D'UNE VIVE ET
FINE IRONIE.

NUEVAS INTUICIONES
ESTÉTICAS DONAN AL
AMBIENTE UNA CHISPA DE
FRESCA Y INUSUAL
ORIGINALIDAD, EN EL SEÑO DE
UNA VIVAZ Y SUTIL IRONIA.









FLORAL



FLORAL

LIGHT AND FORM BECOME TOGETHER
PROTAGONISTS THANKS TO A STRONG
PERSONAL STYLE.

LA LUMIÈRE ET LA FORME
PROTAGONISTES ENSEMBLE, GRÂCE À
UN STYLE PUREMENT PERSONNEL.

LUZ Y FORMA PROTAGONISTAS
JUNTAS, GRACIAS A UN ESTILO
INTENSAMENTE PERSONAL.





FLORAL







FLORAL





FLORAL

THE CREATIVE THOUGHT TURNS INTO A FIRST RATE ARTICLE, ABLE TO UNDERLINE THE GLAMOUR OF THE HOUSE.

L'IDÉE CRÉATIVE SE REFLÈTE DANS UN OBJET DE CLASSE, CAPABLE DE SOULIGNER LE PRESTIGE DE LA MAISON.

EL PENSAMIENTO CREATIVO SE VUELVEN EN OBJETO DE CLASE, CAPAZ DE SUBRAYAR EL PRESTIGIO DE LA CASA.





FLORAL











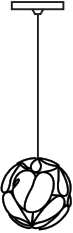



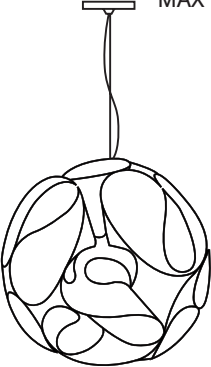

HIROKI TAKADA 2007

FLOOR, TABLE, CEILING AND
SUSPENSIONS IN ALUMINUM.
FITTINGS IN CHROMED METAL
WITH PYREX DIFFUSER.

LAMPE AU SOL, DE TABLE,
PLAFONNIER ET SUSPENSIONS
EN ALUMINIUM. MONTURE EN
MÉTAL CHROMÉ AVEC
DIFFUSEUR EN PYREX.

LAMPARA DE SUELO, DE MESA,
DE PLAFON Y SUSPENSION IN
ALUMINIO. MONTURA EN METAL
CROMADO CON DIFUSOR DE
PYREX.

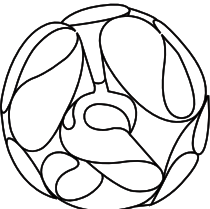
REGISTERED DESIGN

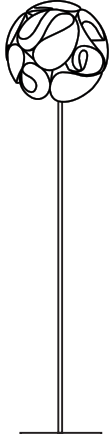
<p>D8-1074 PENDANT MAX 60W G9 </p>  <p>7 3/4" (20 cm)</p>	<p>D8-1075 PENDANT MAX 150W T10 </p>  <p>15 3/4" (40 cm)</p>	<p>D8-1076 PENDANT MAX 150W T10 </p>  <p>23 5/8" (60 cm)</p>
<p>D8-2057 FLUSH MOUNT MAX 60W G9 </p>  <p>7 3/4" (20 cm)</p> <p>CAN BE MOUNTED AS A WALL SCONCE UTILISABLE COME APPLIQUE - UTILIZABLE DA PARED</p>	<p>D8-2058 FLUSH MOUNT MAX 150W T10 </p>  <p>15 3/4" (40 cm)</p> <p>CAN BE MOUNTED AS A WALL SCONCE UTILISABLE COME APPLIQUE - UTILIZABLE DA PARED</p>	<p>D8-4093 TABLE LAMP MAX 60W G9 </p>  <p>7 3/4" (20 cm)</p>
<p>D8-4094 TABLE LAMP MAX 150W T10 </p>  <p>15 3/4" (40 cm)</p>	<p>D8-4095 TABLE LAMP MAX 150W T10 </p>  <p>23 5/8" (60 cm)</p>	<p>D8-4096 FLOOR LAMP MAX 150W T10 </p>  <p>max 76 3/4" (max 195 cm)</p> <p>15 3/4" (40 cm)</p>



SILVIA POMA 2002

RING

THE SPIRIT OF A FREE CREATIVITY OFFERS NEW ACCENTS OF STYLE THANKS TO A SPARKLING MEASURED IRONY THAT LIGHTS THE SPACE WITH BRILLIANT LINES AND ACTUAL COLOURS.

L'ESPRIT D'UNE CREATIVITÉ LIBRE OFFRE DE NOUVEAUX ACCENTS DE STYLE, PARMIS UNE TOUCHÉ D'ÉTINCELANTE MESURÉE HIRONIE, QUI EXCITE L'ESPACE AVEC DE LIGNES BRILLANTES ET DE COULEURS ACTUELLES.

EL ESPIRITU DE UNA CREATIVIDAD LIBRE OFRECE NUEVOS ACENTOS DE ESTILO CON UNA CHISPA DE MEDIDA IRONIA, QUE ENCIENDE EL ESPACIO CON LINEAS BRILLANTES Y COLORES ACTUALES.





RING

SILVIA POMA 2007

FLOOR LAMP AND
SUSPENSIONS IN BLOWN
GLASS AND CHROMED METAL.

LAMPE AU SOL ET
SUSPENSIONS EN VERRE
SOUFFLÉ.
MONTURE EN MÉTAL CHROMÉ.

LÁMPARA DE SUELO Y
SUSPENSIONES EN VIDRIO
SOPLADO. MONTURA DE METAL
CROMADO.

WHITE **BLACK** **RED** **ORANGE** **GREEN**

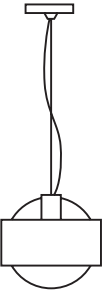
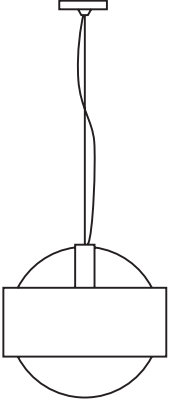
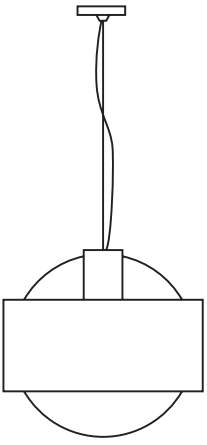
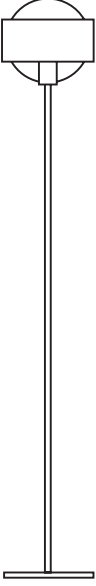

 <p>9" (23 cm)</p> <p>9 7/8" (25 cm)</p>	<p>D8-1085 WHITE PENDANT MAX 100W G25 MED.</p> <p>D8-1086 BLACK</p> <p>D8-1087 RED</p> <p>D8-1088 ORANGE</p> <p>D8-1089 GREEN</p>  <p>14 1/4" (36 cm)</p> <p>15 1/4" (39 cm)</p> <p>D8-1090 WHITE PENDANT MAX 150W T10</p> <p>D8-1091 BLACK</p> <p>D8-1092 RED</p> <p>D8-1093 ORANGE</p> <p>D8-1094 GREEN</p>
 <p>16 7/8" (43 cm)</p> <p>18 1/8" (46 cm)</p> <p>D8-1095 WHITE PENDANT MAX 150W T10</p> <p>D8-1096 BLACK</p> <p>D8-1097 RED</p> <p>D8-1098 ORANGE</p> <p>D8-1099 GREEN</p>	 <p>71" (180 cm)</p> <p>9 7/8" (25 cm)</p> <p>D8-4101 WHITE FLOOR LAMP MAX 150W T10</p> <p>D8-4102 BLACK</p> <p>D8-4103 RED</p> <p>D8-4104 ORANGE</p> <p>D8-4105 GREEN</p>



ENZO PANZERI 2006

TOURBILLON

REGISTERED DESIGN

HARMONY, MOVEMENT AND COLOR,
TOURBILLON IS THE IDEAL
IMAGINATIVE TOUCH TO BRIGHTEN
UP ANY ROOM. A TOUCH OF LIVELY
CREATIVITY THAT TURNS ON THE
PLEASURE OF THE HOME.

HARMONIE, MOUVEMENT, COULEUR.
TOURBILLON INCARNE UNE NOTE
DE FANTASIE IDÉALE POUR
RANIMER LES INTÉRIEURS LES PLUS
VARIÉS. UNE TOUCHE DE CRÉATIVITÉ
PLEINE DE BRIO QUI RAVIVE LE
PLAISIR D'HABITER UN ESPACE.

ARMONÍA, MOVIMIENTO, COLOR.
TURBILLON REPRESENTA UNA NOTA
DE FANTASÍA IDEAL PARA REAVIVAR
LOS AMBIENTES MÁS DIVERSOS. UN
TOQUE DE CREATIVIDAD VIVAZ, QUE
ENCIENDE EL PLACER DE HABITAR.





TOURBILLON





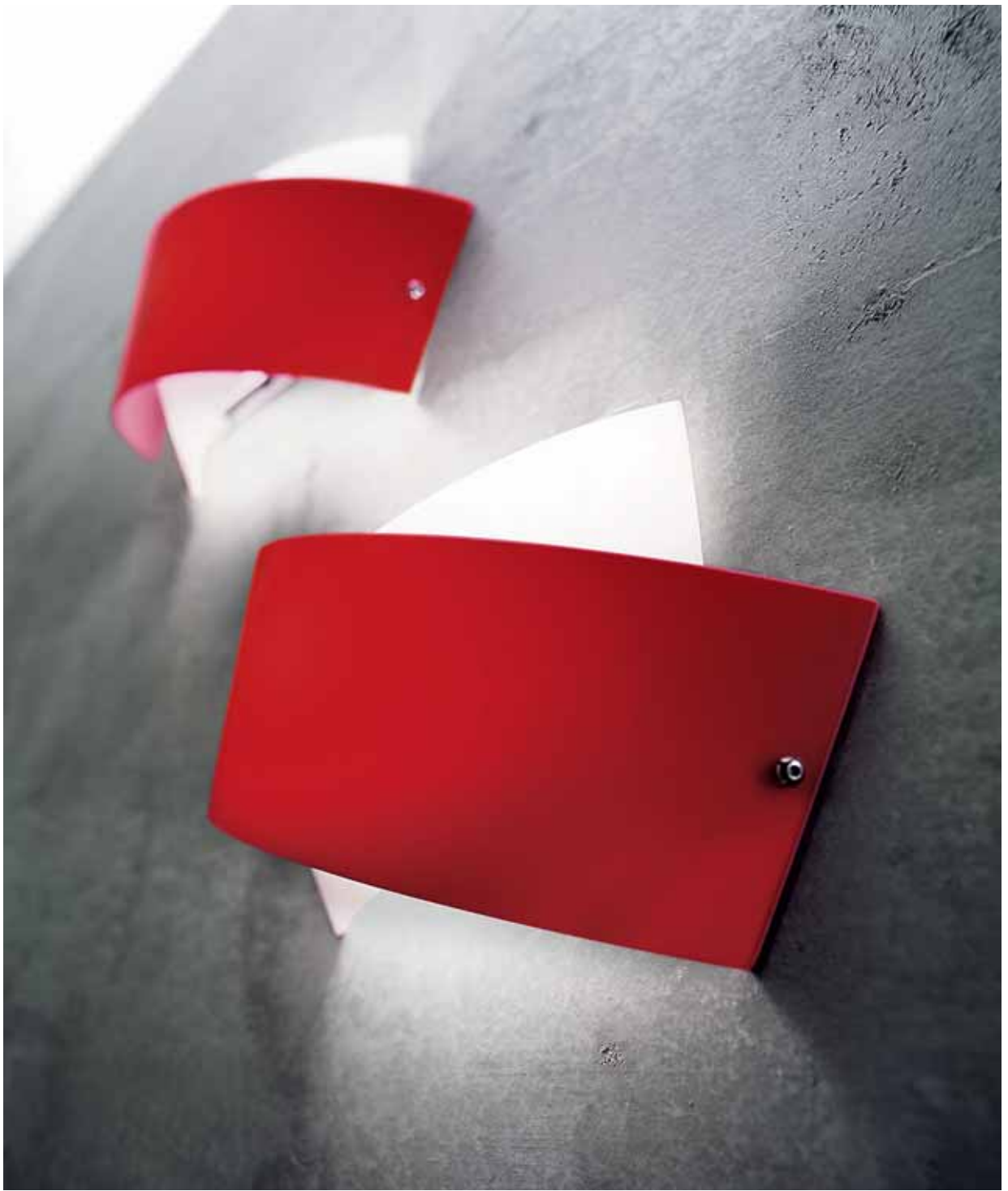





TOURBILLON

A TOUCH OF LIVELY CREATIVITY THAT TURNS ON
THE PLEASURE OF THE HOME.

UN TOQUE DE CREATIVIDAD VIVAZ, QUE
ENCIENDE EL PLACER DE HABITAR.

UNE TOUCHE DE CRÉATIVITÉ PLEINE DE BRIO
QUI RAVIVE LE PLAISIR D'HABITER UN ESPACE.

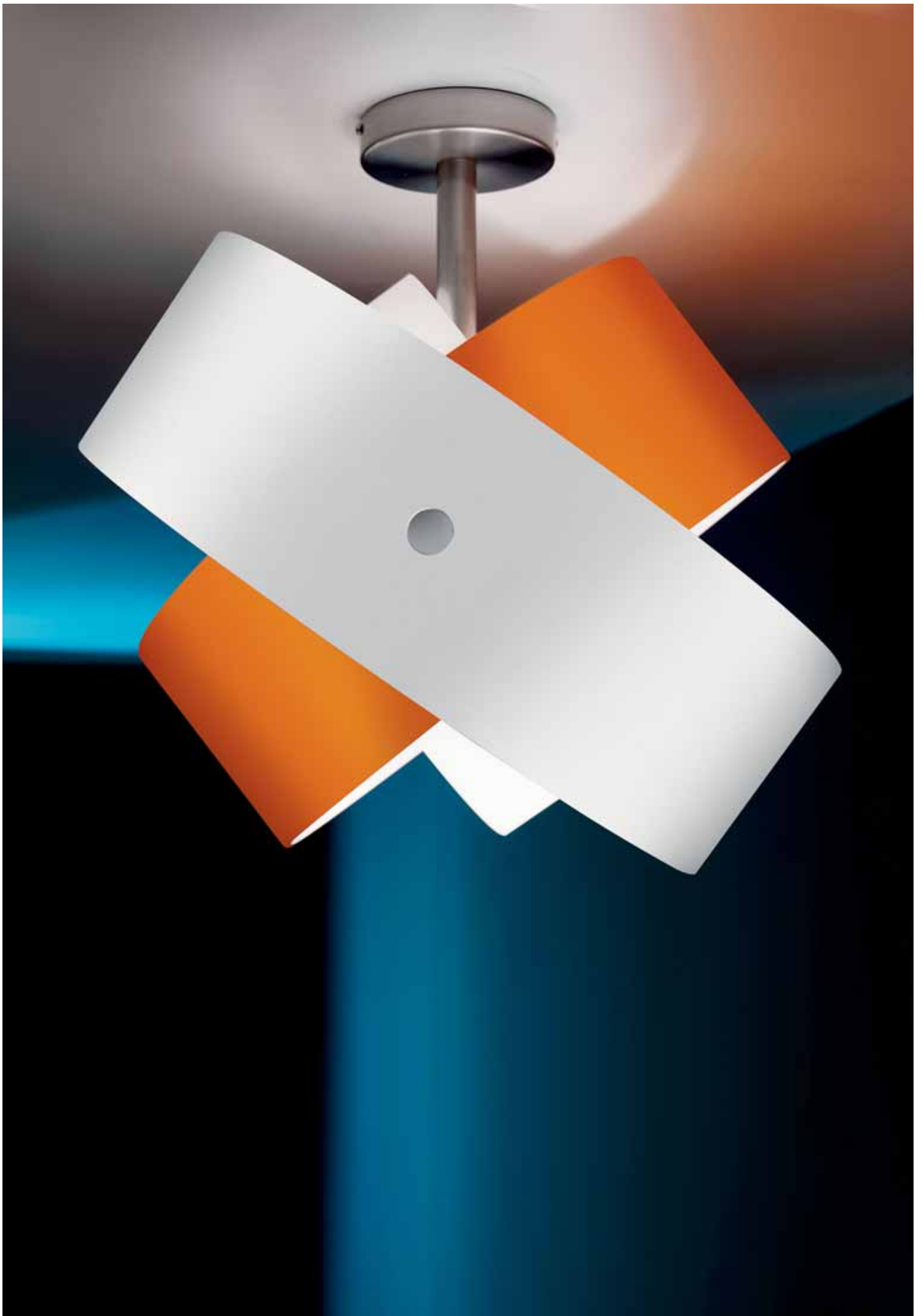

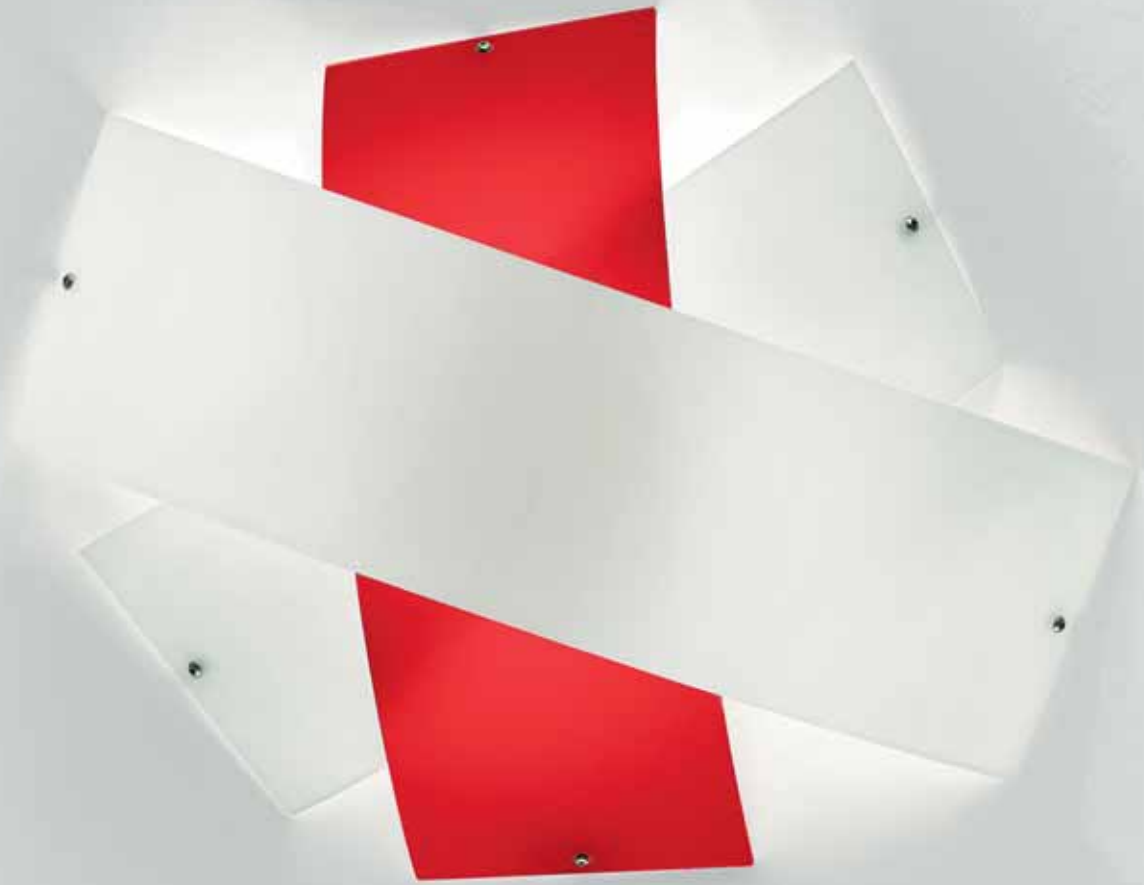



M8933-76 + 5 M9632.16-S

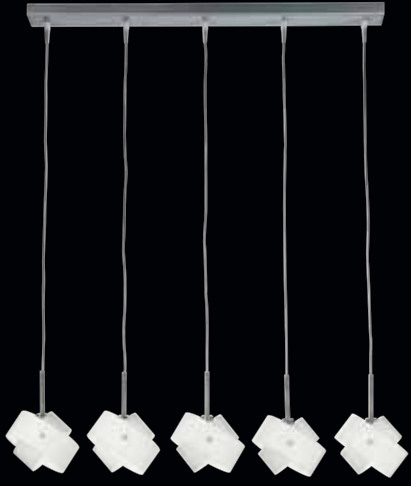

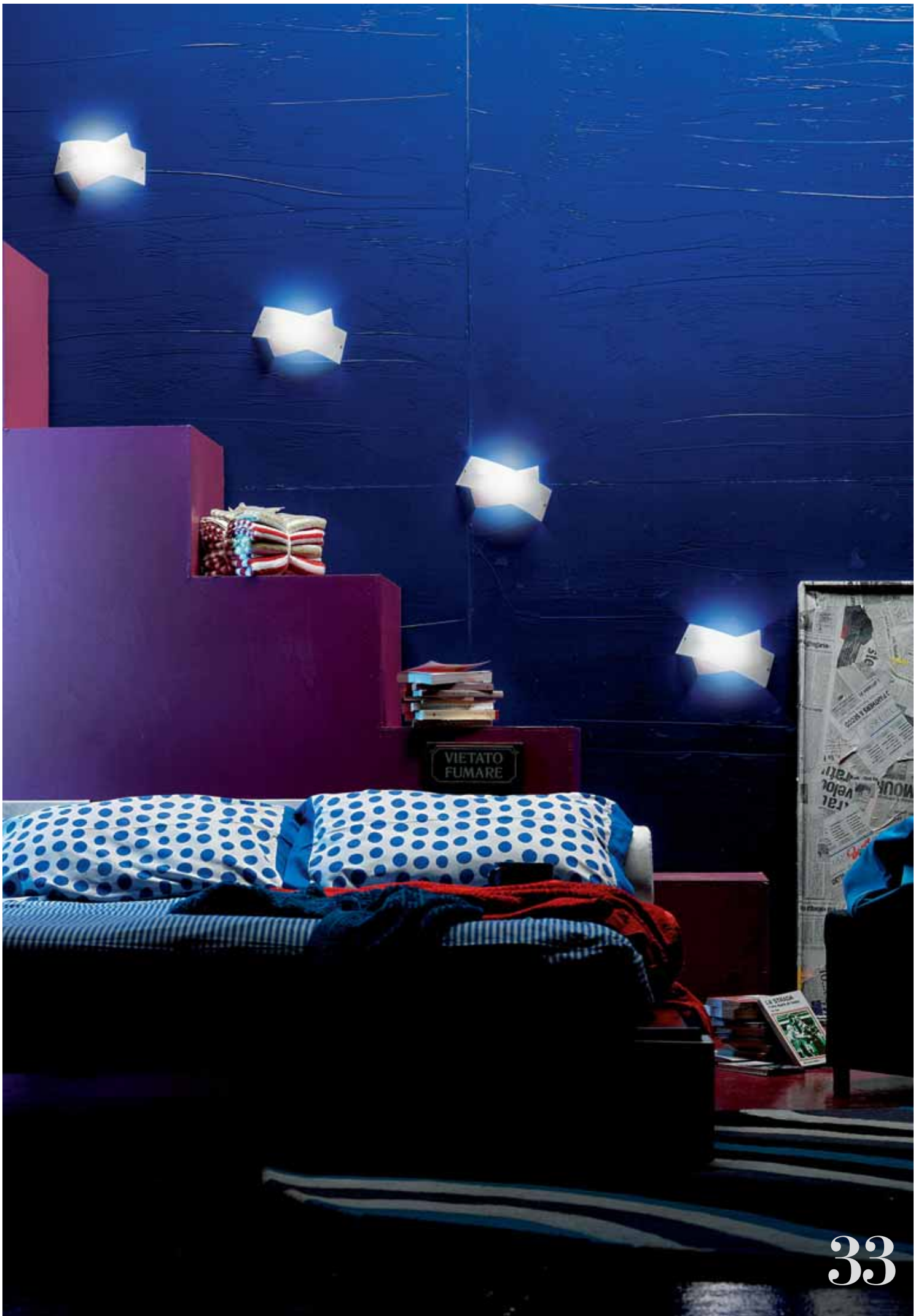

TOURBILLON

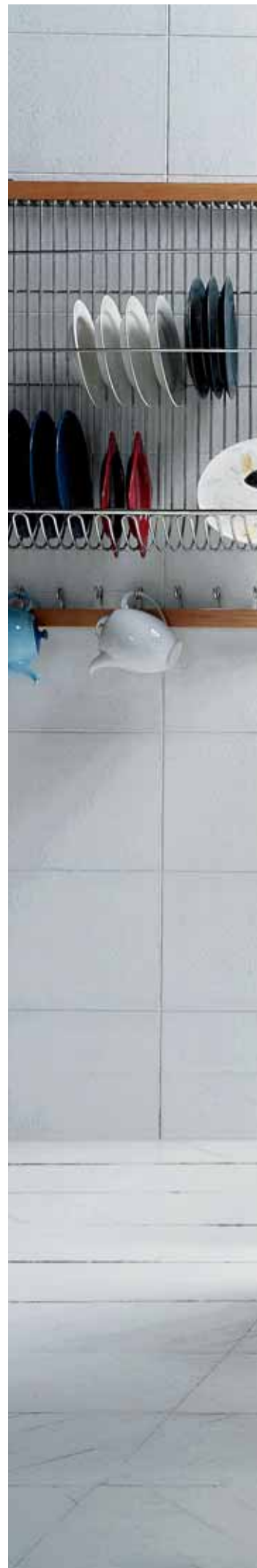





THE NEW YORK COLLECTION



TOURBILLON

ENZO PANZERI

FLOOR, TABLE, CEILING,
WALL LAMP AND
SUSPENSIONS IN
BLOWN GLASS. WHITE
METAL AND NICKEL
DETAILS.

LAMPE AU SOL, DE
TABLE, PLAFONNIERS,
APPLIQUE ET
SUSPENSIONS EN
VERRE SOUFFLÉ.
MONTURE EN
MÉTAL BLANC AVEC
DÉTAILS EN NICKEL.

LÁMPARA DE SUELO,
DE MESA, DE PARED,
DE PLAFONS Y
SUSPENSIONES EN
VIDRIO SOPLADO.
MONTURA DE METAL
BLANCO CON DETALLES
NIQUELADOS.

ITEMS WITH MULTIPLE GLASSES:
LAMPES AVEC PLUSIEURS
VERRES. LÁMPARAS CON VARIOS VIDRIOS:

WHITE/WHITE



WHITE/RED



WHITE/BLACK



WHITE/ORANGE



WHITE/GREEN

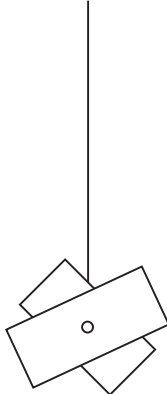
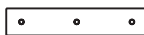
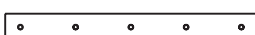
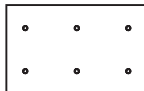
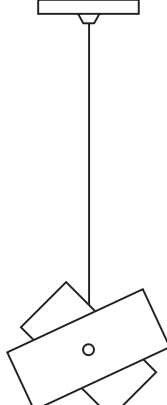
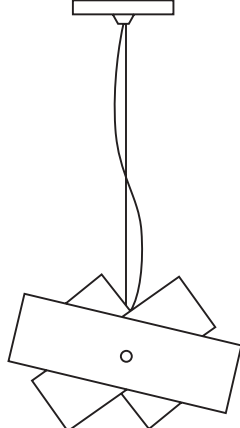

 <p>D8-1144 WHITE/WHITE PENDANT MAX 60W G9</p> <p>D8-1145 WHITE/BLACK</p> <p>D8-1146 WHITE/RED</p> <p>D8-1147 WHITE/ORANGE</p> <p>D8-1148 WHITE/GREEN</p> <p>HOLDER MUST BE ORDERED SEPARATELY</p> <p>7 ³/₄" (12 cm)</p> <p>5 ¹/₂" (14 cm)</p>	<p>PENDANT HOLDER (SOLD SEPARATELY)</p> <p>2 ¹/₂" (6,5 cm)</p>  <p>16 ¹/₂" (42 cm)</p> <p>2 ¹/₂" (6,5 cm)</p>  <p>30" (76 cm)</p> <p>9 ⁷/₈" (25 cm)</p>  <p>16 ¹/₂" (42 cm)</p> <p>D8-1071 GRAY D8-1017 WHITE</p> <p>D8-1073 GRAY D8-1018 WHITE</p> <p>D8-1072 GRAY D8-1019 WHITE</p>
 <p>D8-1100 WHITE/WHITE PENDANT MAX 60W G9</p> <p>D8-1101 WHITE/BLACK</p> <p>D8-1102 WHITE/RED</p> <p>D8-1103 WHITE/ORANGE</p> <p>D8-1104 WHITE/GREEN</p> <p>7 ³/₄" (12 cm)</p> <p>5 ¹/₂" (14 cm)</p>	 <p>D8-1105 WHITE/WHITE PENDANT MAX 100W G30 MED.</p> <p>D8-1106 WHITE/BLACK</p> <p>D8-1107 WHITE/RED</p> <p>D8-1108 WHITE/ORANGE</p> <p>D8-1109 WHITE/GREEN</p> <p>9 ⁷/₈" (25 cm)</p> <p>11 ³/₄" (30 cm)</p>

TOURBILLON

ENZO PANZERI

FLOOR, TABLE, CEILING,
WALL LAMP AND
SUSPENSIONS IN
BLOWN GLASS. WHITE
METAL AND NICKEL
DETAILS.

LAMPE AU SOL, DE
TABLE, PLAFONNIERS,
APPLIQUE ET
SUSPENSIONS EN
VERRE SOUFLÉ.
MONTURE EN
MÉTAL BLANC AVEC
DÉTAILS EN NICKEL.

LÁMPARA DE SUELO,
DE MESA, DE PARED,
DE PLAFONS Y
SUSPENSIONES EN
VIDRIO SOPLADO.
MONTURA DE METAL
BLANCO CON DETALLES
NIQUELADOS.

D8-2076
WHITE/WHITE
FLUSH MOUNT
MAX 150W T3Q
(119 mm) 

D8-2077
WHITE/BLACK

D8-2078
WHITE/RED

D8-2079
WHITE/ORANGE

D8-2080
WHITE/GREEN

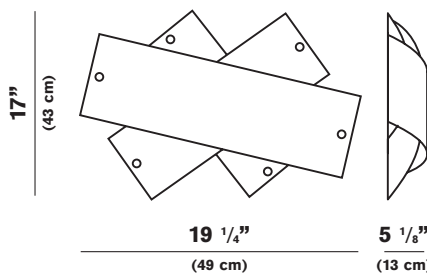

CAN BE MOUNTED AS A WALL SCONCE
UTILISABLE COME APPLIQUE - UTILIZABLE DA PARED

D8-3096
WHITE/WHITE
WALL SCONCE
MAX 100W T3Q/3
(79 mm) 

D8-3105
WHITE/BLACK

D8-3095
WHITE/RED

D8-3106
WHITE/ORANGE

D8-3107
WHITE/GREEN

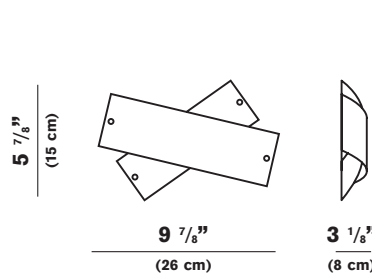

D8-2081
WHITE/WHITE
SEMI FLUSH MOUNT
MAX 60W G9 

D8-2082
WHITE/BLACK

D8-2083
WHITE/RED

D8-2084
WHITE/ORANGE

D8-2085
WHITE/GREEN

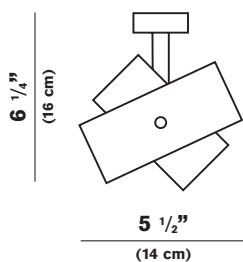

D8-2086
WHITE/WHITE
SEMI FLUSH MOUNT
MAX 100W G30 MED. 

D8-2087
WHITE/BLACK

D8-2088
WHITE/RED

D8-2089
WHITE/ORANGE

D8-2090
WHITE/GREEN

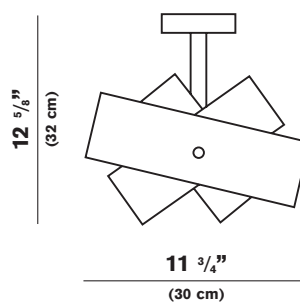

ITEMS WITH MULTIPLE GLASSES:
 LAMPES AVEC PLUSIEURS
 VERRES.LÁMPARAS CON VARIOS VIDRIOS:

WHITE/WHITE



WHITE/RED



WHITE/BLACK



WHITE/ORANGE



WHITE/GREEN



<div data-bbox="172 943 411 1279" data-label="Image"> </div> <div data-bbox="590 698 751 806" data-label="Text"> <p>D8-4111 WHITE/WHITE TABLE LAMP MAX 60W G9</p> </div> <div data-bbox="590 851 754 909" data-label="Text"> <p>D8-4112 WHITE/BLACK</p> </div> <div data-bbox="590 940 726 999" data-label="Text"> <p>D8-4113 WHITE/RED</p> </div> <div data-bbox="590 1032 777 1090" data-label="Text"> <p>D8-4114 WHITE/ORANGE</p> </div> <div data-bbox="590 1124 759 1182" data-label="Text"> <p>D8-4115 WHITE/GREEN</p> </div>	<div data-bbox="869 891 1177 1279" data-label="Image"> </div> <div data-bbox="1279 698 1522 806" data-label="Text"> <p>D8-4116 WHITE/WHITE TABLE LAMP MAX 100W G30 MED.</p> </div> <div data-bbox="1279 851 1450 909" data-label="Text"> <p>D8-4117 WHITE/BLACK</p> </div> <div data-bbox="1279 940 1422 999" data-label="Text"> <p>D8-4118 WHITE/RED</p> </div> <div data-bbox="1279 1032 1474 1090" data-label="Text"> <p>D8-4119 WHITE/ORANGE</p> </div> <div data-bbox="1279 1124 1453 1182" data-label="Text"> <p>D8-4120 WHITE/GREEN</p> </div>
---	---

YOHJI TERAZERI 2006

DOMINO INOX

STYLE AND RATIONALITY BLEND
IN THE MEASURED FORMS OF
THIS COLLECTION. THE CLEAR
BALANCED DESIGN CREATES A
HARMONY EXPRESSING PURE
ELEGANCE.

LE STYLE ET LA RATIONALITÉ SE
JOIGNENT DANS LES FORMES
MESURÉES DE CETTE
COLLECTION. L'ÉQUILIBRE DU
DESIGN CRÉE UNE HARMONIE
QUI EXPRIME LA PURETÉ DE
L'ELEGANCE.

ESTILO Y RACIONALIDAD SE
ENCUENTRAN EN LAS FORMAS
MEDIDAS DE ESTA COLECCIÓN.
EL CLARO EQUILIBRO DEL
DISEÑO CREA UNA ARMONIA
CON EXPRESIÓN DE PURA
ELEGANCIA.

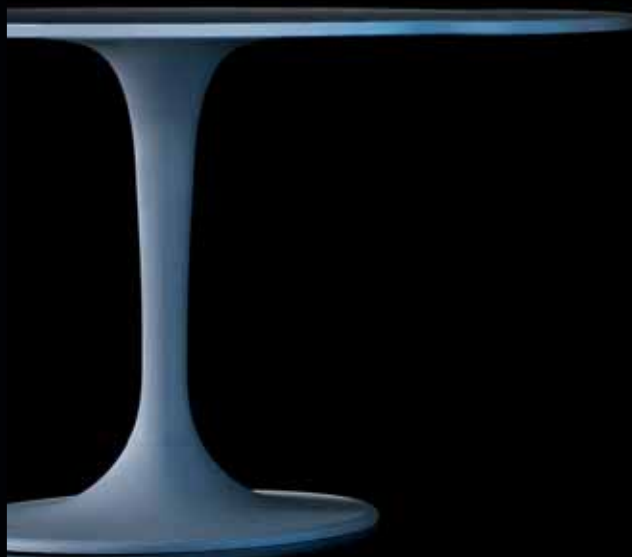





DOMINO INOX





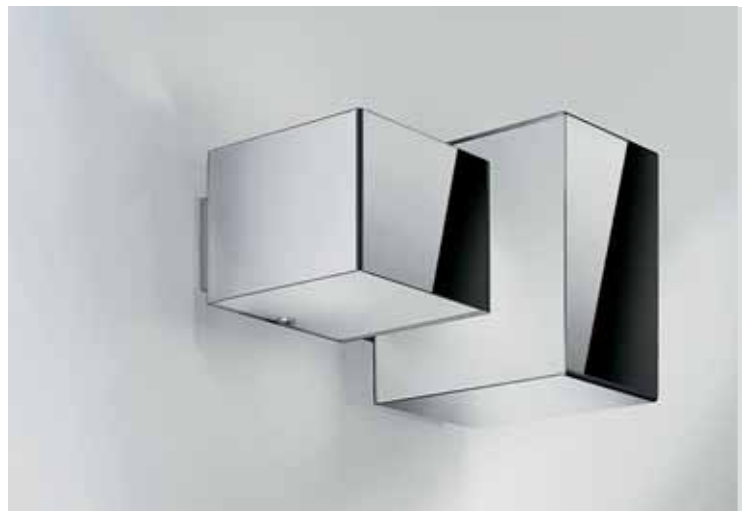

DOMINO INOX

CEILING/WALL LAMPS IN
STAINLESS STEEL AND
METALLIZED GREY METAL PART
AND PROTECTION GLASSES.

APPLIQUE/PLAFONNIER
EN ACIER INOXYDABLE.
MONTURE EN GRIS MÉTALLISÉ
AVEC DE VERRES DE
PROTECTION.

PARED/PLAFONES DE ACERO
INOXIDABLE Y MONTURA DE
METAL GRIS CON VIDROS DE
PROTECCIÓN.

YOHJI TERAZERI 2006

<p>D8-2072 FLUSH MOUNT INOX MAX 60W G9</p> <p>5" (13 cm)</p> <p>4 1/4" (11 cm) 3 1/4" (8 cm)</p> <p>CAN BE MOUNTED AS A WALL SCONCE UTILISABLE COME APPLIQUE - UTILIZABLE DA PARED</p>	<p>D8-2073 FLUSH MOUNT INOX MAX 60W G9</p> <p>6 1/4" (16 cm)</p> <p>5 1/2" (14 cm) 3 1/2" (9 cm)</p> <p>CAN BE MOUNTED AS A WALL SCONCE UTILISABLE COME APPLIQUE - UTILIZABLE DA PARED</p>	<p>D8-2074 FLUSH MOUNT INOX MAX 2x60W G9</p> <p>6 1/4" (16 cm)</p> <p>9" (23 cm) 9" (23 cm)</p> <p>CAN BE MOUNTED AS A WALL SCONCE UTILISABLE COME APPLIQUE - UTILIZABLE DA PARED</p>
<p>D8-2075 FLUSH MOUNT INOX MAX 3x40W G9</p> <p>5" (13 cm)</p> <p>13" (33 cm) 3 1/2" (9 cm)</p> <p>CAN BE MOUNTED AS A WALL SCONCE UTILISABLE COME APPLIQUE - UTILIZABLE DA PARED</p>		

DOMINO

YOHJI TERAZERI

PENDANTS, WALL/CEILING, TABLE, FLOOR LAMP IN METALLIZED GREY METAL. BLOWN WHITE MATTE GLASS OR BLACK OR RED. IN MULTIPLE SHADE VERSIONS (FLOOR AND WALL/CEILING LAMP) AVAILABLE COMBINATIONS ARE WHITE/WHITE, WHITE/BLACK OR WHITE/RED.

SUSPENSIONS, LAMPE AU SOL, DE TABLE ET APPLIQUE / PLAFONNIERS EN GRIS MÉTALLISÉ. VERRE SOUFFLÉ BLANC SATINÉ OU NOIR OU ROUGE. COMBINAISON DE COULEURS POUR LAMPE AU SOL ET APPLIQUE/PLAFONNIERS SONT BLANC/BLANC OU BLANC/NOIR OU BLANC/ROUGE.

LÁMPARA DE SUELO, DE MESA, DE PARED/PLAFONES Y SUSPENSIONES EN GRIS METALIZADO. VIDRIO SOPLADO BLANCO SATINADO O ROJO O NEGRO. COMBINACIÓN DE COLORES POR LÁMPARA DE SUELO, DE PARED/PLAFONES SON BLANCO/BLANCO O BLANCO/NEGRO O BLANCO/ROJO.

ITEMS WITH SINGLE GLASS:

LAMPES AVEC UN SEUL VERRE:
LÁMPARAS CON UNO VIDRIO:

WHITE



BLACK

RED

ORANGE

GREEN

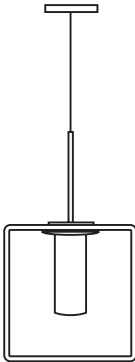
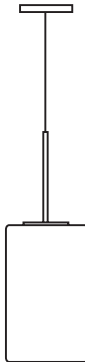
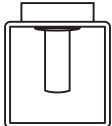
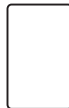
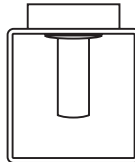
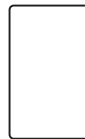

<div style="display: flex; justify-content: space-around; align-items: center;"> <div style="text-align: center;">  <p>10 1/4" (26 cm)</p> <p>4 3/8" (11 cm)</p> </div> <div style="text-align: center;">  <p>3 1/8" (8 cm)</p> </div> </div> <div style="margin-top: 20px;"> <p>D8-1045 WHITE PENDANT MAX 60W G9</p> <p>D8-1046 BLACK</p> <p>D8-1047 RED</p> <p>D8-1048 ORANGE</p> <p>D8-1049 GREEN</p> </div>	<div style="display: flex; justify-content: space-around; align-items: center;"> <div style="text-align: center;">  <p>11 3/8" (28 cm)</p> <p>5 1/2" (14 cm)</p> </div> <div style="text-align: center;">  <p>3 1/2" (9 cm)</p> </div> </div> <div style="margin-top: 20px;"> <p>D8-1048 WHITE PENDANT MAX 60W G9</p> <p>D8-1049 BLACK</p> <p>D8-1050 RED</p> <p>D8-1083 ORANGE</p> <p>D8-1084 GREEN</p> </div>
<div style="display: flex; justify-content: space-around; align-items: center;"> <div style="text-align: center;">  <p>5 1/4" (13 cm)</p> <p>4 3/8" (11 cm)</p> </div> <div style="text-align: center;">  <p>3 1/8" (8 cm)</p> </div> </div> <div style="margin-top: 20px;"> <p>D8-2033 WHITE FLUSH MOUNT MAX 60W G9</p> <p>D8-2034 BLACK</p> <p>D8-2035 RED</p> <p>D8-2062 ORANGE</p> <p>D8-2063 GREEN</p> </div>	<div style="display: flex; justify-content: space-around; align-items: center;"> <div style="text-align: center;">  <p>6 1/4" (16 cm)</p> <p>5 1/2" (14 cm)</p> </div> <div style="text-align: center;">  <p>3 1/2" (9 cm)</p> </div> </div> <div style="margin-top: 20px;"> <p>D8-2036 WHITE FLUSH MOUNT MAX 60W G9</p> <p>D8-2037 BLACK</p> <p>D8-2038 RED</p> <p>D8-2064 ORANGE</p> <p>D8-2065 GREEN</p> </div>





DOMINO

YOHJI TERAZERI

ITEMS WITH SINGLE GLASS:

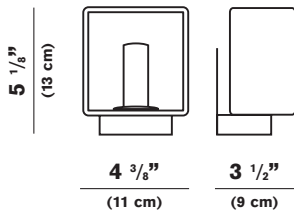
LAMPES AVEC UN SEUL VERRE:
LÁMPARAS CON UNO VIDRIO:

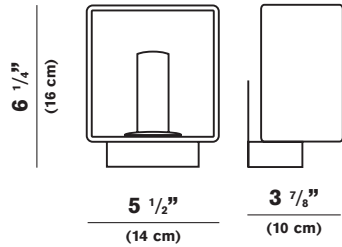

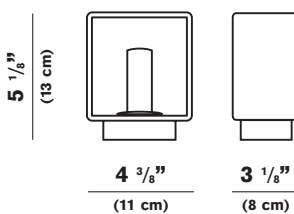
<p>D8-3068 WHITE WALL SCONCE MAX 75W G9 ADA </p> <p>D8-3069 BLACK</p> <p>D8-3070 RED</p> <p>D8-3101 ORANGE</p> <p>D8-3102 GREEN</p>  <p>5 ¹/₈" (13 cm)</p> <p>4 ³/₈" (11 cm)</p> <p>3 ¹/₂" (9 cm)</p>	<p>D8-3071 WHITE WALL SCONCE MAX 75W G9 ADA </p> <p>D8-3072 BLACK</p> <p>D8-3073 RED</p> <p>D8-3103 ORANGE</p> <p>D8-3104 GREEN</p>  <p>6 ¹/₄" (16 cm)</p> <p>5 ¹/₂" (14 cm)</p> <p>3 ⁷/₈" (10 cm)</p>
<p>D8-4079 WHITE WALL SCONCE MAX 75W G9 </p> <p>D8-4080 BLACK</p> <p>D8-4081 RED</p> <p>D8-4097 ORANGE</p> <p>D8-4098 GREEN</p>  <p>5 ¹/₈" (13 cm)</p> <p>4 ³/₈" (11 cm)</p> <p>3 ¹/₈" (8 cm)</p>	

DOMINO

YOHJI TERAZERI

PENDANTS, WALL/CEILING, TABLE, FLOOR LAMP IN METALLIZED GREY METAL. BLOWN WHITE MATTE GLASS OR BLACK OR RED. IN MULTIPLE SHADE VERSIONS (FLOOR AND WALL/CEILING LAMP) AVAILABLE COMBINATIONS ARE WHITE/WHITE, WHITE/BLACK OR WHITE/RED.

SUSPENSIONS, LAMPE AU SOL, DE TABLE ET APPLIQUE / PLAFONNIERS EN GRIS MÉTALLISÉ. VERRE SOUFFLÉ BLANC SATINÉ OU NOIR OU ROUGE. COMBINAISON DE COULEURS POUR LAMPE AU SOL ET APPLIQUE/PLAFONNIERS SONT BLANC/BLANC OU BLANC/NOIR OU BLANC/ROUGE.

LÁMPARA DE SUELO, DE MESA, DE PARED/PLAFONES Y SUSPENSIONES EN GRIS METALIZADO. VIDRIO SOPLADO BLANCO SATINADO O ROJO O NEGRO. COMBINACIÓN DE COLORES POR LÁMPARA DE SUELO, DE PARED/PLAFONES SON BLANCO/BLANCO O BLANCO/NEGRO O BLANCO/ROJO.

ITEMS WITH MULTIPLE GLASSES.

LAMPES AVEC PLUSIEURS VERRES.
LÁMPARAS CON VARIOS VIDRIOS.

WHITE/WHITE

WHITE/BLACK

WHITE/RED

WHITE/ORANGE

WHITE/GREEN

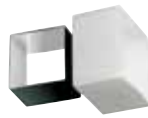

D8-2039
WHITE/WHITE
FLUSH MOUNT
MAX 2x60W G9

D8-2040
WHITE/BLACK

D8-2041
WHITE/RED

D8-2066
WHITE/ORANGE

D8-2067
WHITE/GREEN

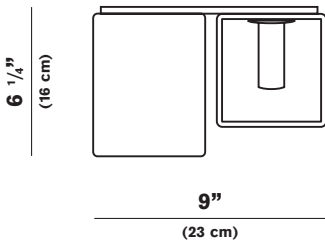
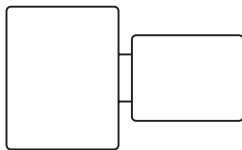

CAN BE MOUNTED AS A WALL SCONCE
UTILISABLE COME APPLIQUE - UTILIZABLE DA PARED

D8-2042
WHITE/WHITE
FLUSH MOUNT
MAX 4x40W G9

D8-2043
WHITE/BLACK

D8-2044
WHITE/RED

D8-2068
WHITE/ORANGE

D8-2069
WHITE/GREEN

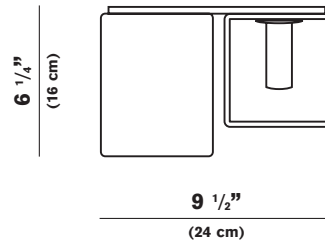
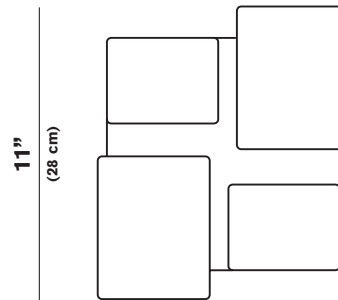

CAN BE MOUNTED AS A WALL SCONCE
UTILISABLE COME APPLIQUE - UTILIZABLE DA PARED

DOMINO

YOHJI TERAZERI

ITEMS WITH MULTIPLE GLASSES.

LAMPES AVEC PLUSIEURS VERRES.
LÂMPARAS CON VARIOS VIDRIOS.

WHITE/WHITE



WHITE/BLACK

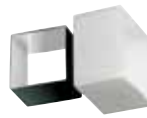

WHITE/RED



WHITE/ORANGE



WHITE/GREEN

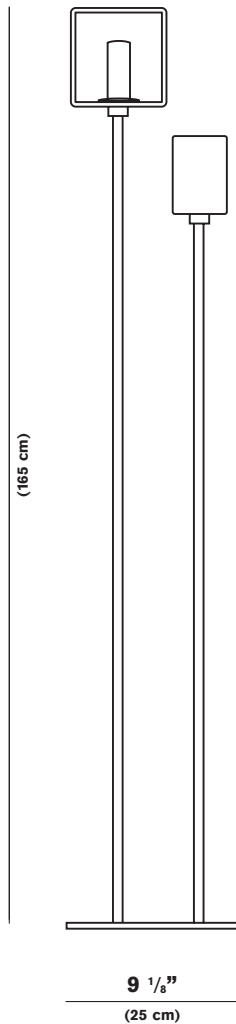

D8-4082
WHITE/WHITE
FLOOR LAMP
MAX 2x75W G9

D8-4083
WHITE/BLACK

D8-4084
WHITE/RED

D8-4099
WHITE/ORANGE

D8-4100
WHITE/GREEN

D8-2045
WHITE/WHITE
FLUSH MOUNT
MAX 9x40W G9

D8-2046
WHITE/BLACK

D8-2047
WHITE/RED

D8-2070
WHITE/ORANGE

D8-2071
WHITE/GREEN

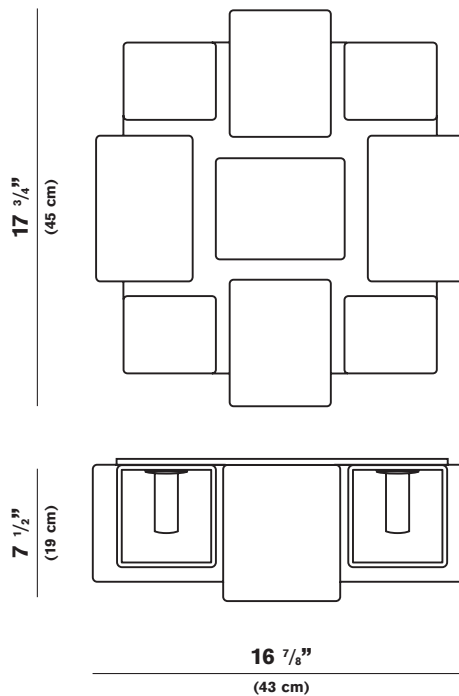

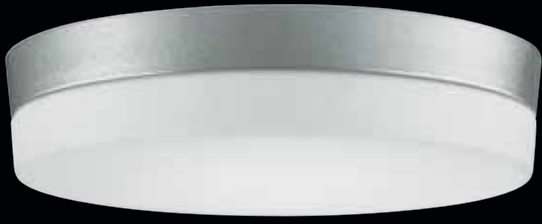

ENZO PANZERI 2007

FLAN

SOURCES OF LIGHT UNDERLINING SPACE. A MINIMALIST AND SOBER AESTHETIC MARKED BY A CONTEMPORARY SIGN OPEN TO NEW VALUES READY TO ENLIGHTEN OUR TIME.





SOURCES DE LUMIÈRE SOULIGNENT L'ESPACE. UNE ESTHÉTIQUE MINIMALISTE ET SOBRE DISTINCTEMENT CONTEMPORAINE OUVRE AUX NOUVELLES VALEURS DÉJÀ PRÊTES POUR ÉCLARER NOTRE TEMPS.

FUENTES DE LUZ SUBRAYANDO EL ESPACIO, CON UNA ESTETICA MINIMALISTA Y SOBRIA MARCADAMENTE CONTEMPORÁNEA. NUEVOS VALORES PREPARADOS PARA ILUMINAR NUESTRO TIEMPO.





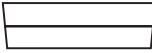

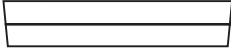
<p>D8-2059 WALL SCONCE MAX 40W G9 ADA </p> <p>$3 \frac{3}{4}"$ (9,5 cm)</p>  <p>$5 \frac{1}{2}"$ (14 cm)</p> <p>CAN BE MOUNTED AS A WALL SCONCE UTILISABLE COME APPLIQUE - UTILIZABLE DA PARED</p>	<p>D8-2060 WALL SCONCE MAX 2x26W G24 Q3 </p> <p>$4"$ (10 cm)</p>  <p>$10 \frac{1}{4}"$ (26 cm)</p> <p>CAN BE MOUNTED AS A WALL SCONCE UTILISABLE COME APPLIQUE - UTILIZABLE DA PARED</p>	<p>D8-2061 WALL SCONCE MAX 22W + 40W T5 CIRC. 2GX13 </p> <p>$4"$ (10 cm)</p>  <p>$18 \frac{1}{8}"$ (46 cm)</p> <p>CAN BE MOUNTED AS A WALL SCONCE UTILISABLE COME APPLIQUE - UTILIZABLE DA PARED</p>
---	--	---

ENZO PANZERI 2007

WILLY 100

SIMPLICITY AS A TIMELESS AESTHETIC RULE, GIVES CHARM THAT PERFECTLY FITS IN WITH THE ELEGANCE AND PERSONALITY OF ANY FURNISHING CONTEXT.

LA SIMPLICITE COMME REGLE ESTHETIQUE ETERNELLE, OFFRE UN CHARME QUI SAIT S'INSERER AVEC CLASSE ET PERSONNALITE DANS N'IMPORTE QUEL CONTEXTE D'AMEUBLEMENT.

LA SIMPLICIDAD COMO REGLA ESTÉTICA INTRAMONTABLE, REGALA UN ENCANTO QUE SABE INTRODUCIRSE CON CLASE Y PERSONALIDAD EN CUALQUIER CONTEXTO DE DECORACIÓN.









WILLY

ENZO PANZERI 2007

SUSPENSION OF
POLYETHYLENE WITH FITTINGS
IN METALLIZED GREY METAL AND
GLASS SHEET AS DIFFUSER.
ALSO AVAILABLE MODEL WITH
METAL HALIDE LAMPS.

SUSPENSION EN POLYÉTHYLÈNE
AVEC MONTURE GRIS
MÉTALLISÉE ET DIFFUSEUR EN
PLAQUE DE VERRE. VERSION
AVEC LAMPES AUX
HALOGÉNURES MÉTALLIQUES
AUSSI.

SUSPENSION IN POLIETILENO
CON MONTURA GRIS
METALIZADO Y DIFUSOR EN
LASTRA DE VIDRIO. DISPONIBLE
EN LA VERSION CON LAMPARA
DE ALOGENURO METALICO
TAMBIEN.

D8-1077 WHITE
PENDANT
MAX 4x100W MED.



D8-1078 BLACK
PENDANT
MAX 4x100W MED.



D8-1079 WHITE
PENDANT
MAX 150W MED. HQI
METAL HALIDE



D8-1080 BLACK
PENDANT
MAX 150W MED. HQI
METAL HALIDE

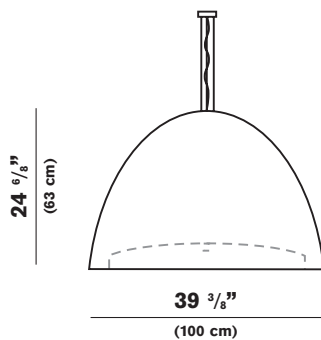

ENZO PANZERI 2005

ALL STARS

COLOR, WARMTH AND A PINCH OF IRONY HAVE GIVEN LIFE TO NEW LIGHTING SOLUTIONS IN A PERSPECTIVE OF PERFECT HARMONY BETWEEN ELEGANCE AND CREATIVITY.

COULEUR, CHALEUR ET UNE PINCEE D'IRONIE SONT LES ELEMENTS QUI CREENT DE NOUVELLES SOLUTIONS D'ECLAIRAGE. DANS UN CADRE D'HARMONIE PARFAITE ENTRE ELEGANCE ET CREATIVITE.

COLOR, CALOR Y UNA PIZCA DE IRONIA SON LOS ELEMENTOS QUE DAN VIDA A NUEVAS SOLUCIONES DE LUZ. EN UN CUADRO DE PERFECTA ARMONIA ENTRE ELEGANCIA Y CREATIVIDAD.







ALL STARS

ENZO PANZERI

CEILING AND WALL LAMP WITH
FRAME IN SANDED ALUMINUM.
MATTE GLASS AND STAINLESS
INOX WIRE WITH COLORED
GLASS BALLS.
ELECTRONIC BALLAST.

LAMPE DE PLAFON ET APPLIQUE
AVEC CADRE EN ALUMINIUM
SABLÉ. VERRE SATINÉ ET FIL
ACIER INOXYDABLE AVEC DES
PERLES EN VERRE COLORÉ.
VERSION FLUORESCENT AVEC
REACTEUR ÉLECTRONIQUE.
LÁMPARA DE PARED Y DE

TECHO CON MARCO IN
ARENADO ALUMINIO. VIDRIO
SATINADO Y ALAMBRE ACERO
INOXIDABLE CON PERLAS DE
VIDRIO COLORADO VERSIÓN
FLUORESCENTE CON REACTOR
ELECTRÓNICO.

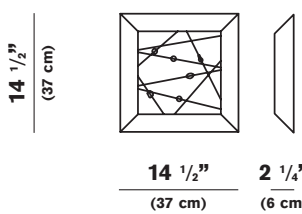
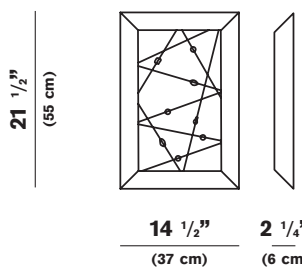
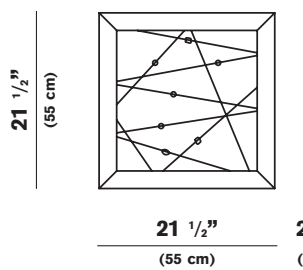
<p>D8-3098 WHITE</p> <p>D8-3080 FLUO ALUMINUM WALL SCONCE MAX 2x18W 2G11</p>  <p>14 1/2" (37 cm)</p> <p>14 1/2" (37 cm)</p> <p>2 1/4" (6 cm)</p> <p>ELECTRONIC BALLAST INCLUDED AVEC ALIMENTATEUR ÉLECTRONIQUE ALIMENTADOR ELECTRÓNICO INCLUIDO CAN BE MOUNTED AS A CEILING LIGHT UTILISABLE COMME PLAFONNIER UTILIZABLE COMO PLAFÓN</p>	<p>D8-3099 WHITE</p> <p>D8-3081 ALUMINUM WALL SCONCE MAX 2x36W 2G11</p>  <p>21 1/2" (55 cm)</p> <p>14 1/2" (37 cm)</p> <p>2 1/4" (6 cm)</p> <p>ELECTRONIC BALLAST INCLUDED AVEC ALIMENTATEUR ÉLECTRONIQUE ALIMENTADOR ELECTRÓNICO INCLUIDO CAN BE MOUNTED AS A CEILING LIGHT UTILISABLE COMME PLAFONNIER UTILIZABLE COMO PLAFÓN</p>	<p>D8-3100 WHITE</p> <p>D8-3082 ALUMINUM WALL SCONCE MAX 4x36W 2G11</p>  <p>21 1/2" (55 cm)</p> <p>21 1/2" (55 cm)</p> <p>2 1/4" (6 cm)</p> <p>ELECTRONIC BALLAST INCLUDED AVEC ALIMENTATEUR ÉLECTRONIQUE ALIMENTADOR ELECTRÓNICO INCLUIDO CAN BE MOUNTED AS A CEILING LIGHT UTILISABLE COMME PLAFONNIER UTILIZABLE COMO PLAFÓN</p>
--	---	---

SNAKE

HANDCRAFT PRODUCT "MADE IN ITALY".
MANUFACTURED IN RECYCLED LEATHER
OBTAINED FROM LEATHER FIBRES, LATEX AND
NATURAL GREASE. RESPECT FOR THE
ENVIRONMENT, FLEXIBILITY, RESISTANCE AND
NATURAL AGING PROCESS ARE THE
FUNDAMENTAL FEATURES THAT MAKE THIS
MATERIAL INNOVATIVE AND AT TOP QUALITY
STANDARDS.

PRODUIT ARTISANAL "MADE IN ITALY", EN CUIR
RÉGÉNÉRÉ: MATÉRIEL COMPOSÉ PAR DE
FIBRES DE CUIR, LATEX ET GRAS NATURELS.
RESPECT POUR L'ENVIRONNEMENT,
FLEXIBILITÉ, RÉSISTANCE ET UN NATUREL
VIEILLISSEMENT SONT LES
CARACTÉRISTIQUES FONDAMENTALES QUI
RENDENT CE MATÉRIEL INNOVANT ET DE
SUPERBE QUALITÉ.

PRODUCTO DE ARTISÁN "MADE IN ITALY".
FABRICADO EN CUERO RECICLADO,
OBTENIDO DE LAS FIBRAS DE CUERO, LÁTEX
Y GRASA NATURAL. EL RESPECTO POR EL
AMBIENTE, LA FLEXIBILIDAD, LA RESISTENCIA
Y EL PROCESO NATURAL DEL
ENVEJECIMIENTO SON LAS CARACTERÍSTICAS
FUNDAMENTALES QUE HACEN ESTE
MATERIAL DINÁMICO Y DE ALTÍSIMA CALIDAD.











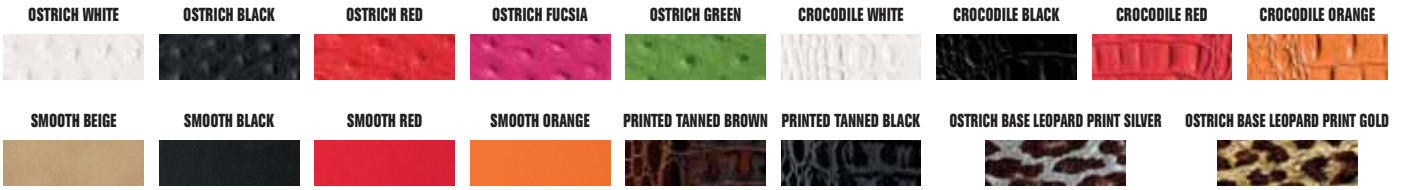

SNAKE

MANUFACTURED IN RECYCLED LEATHER, AN ECOLOGIC MATERIAL OBTAINED FROM LEATHER FIBRES, LATEX AND NATURAL GREASE.

PRODUIT ARTISANAL EN CUIR RÉGÉNÉRÉ: MATÉRIEL ÉCOLOGIQUE, COMPOSÉ PAR DE FIBRES DE CUIR, LATEX ET GRAS NATURELS.

FABRICADO EN CUERO RECICLADO, UN MATERIAL ECOLÓGICO OBTENIDO DE LAS FIBRAS DE CUERO, LÁTEX Y GRASA NATURAL.



 <p>26" (66 cm)</p> <p>8 1/4" (21 cm)</p>	<p>D8-1127 SMOOTH BEIGE PENDANT MAX 100W MED.  ADA</p>	<p>D8-1128 SMOOTH BLACK</p> <p>D8-1129 SMOOTH RED</p> <p>D8-1130 SMOOTH ORANGE</p> <p>D8-1131 CROCODILE WHITE</p> <p>D8-1132 CROCODILE BLACK</p> <p>D8-1133 CROCODILE RED</p>	<p>D8-1134 CROCODILE ORANGE</p> <p>D8-1135 OSTRICH WHITE</p> <p>D8-1136 OSTRICH BLACK</p> <p>D8-1137 OSTRICH RED</p> <p>D8-1138 OSTRICH FUCSIA</p> <p>D8-1139 OSTRICH GREEN</p>	<p>D8-1140 LEOPARD SILVER</p> <p>D8-1141 LEOPARD GOLD</p> <p>D8-1142 PRINTED TANNED BROWN</p> <p>D8-1143 PRINTED TANNED BLACK</p>
 <p>26 3/4" (68 cm)</p> <p>9" (23 cm)</p>	<p>D8-4206 SMOOTH BEIGE TABLE LAMP MAX 100W MED.  ADA</p>	<p>D8-4207 SMOOTH BLACK</p> <p>D8-4208 SMOOTH RED</p> <p>D8-4209 SMOOTH ORANGE</p> <p>D8-4210 CROCODILE WHITE</p> <p>D8-4211 CROCODILE BLACK</p> <p>D8-4212 CROCODILE RED</p>	<p>D8-4213 CROCODILE ORANGE</p> <p>D8-4214 OSTRICH WHITE</p> <p>D8-4215 OSTRICH BLACK</p> <p>D8-4216 OSTRICH RED</p> <p>D8-4217 OSTRICH FUCSIA</p> <p>D8-4218 OSTRICH GREEN</p>	<p>D8-4219 LEOPARD SILVER</p> <p>D8-4220 LEOPARD GOLD</p> <p>D8-4221 PRINTED TANNED BROWN</p> <p>D8-4222 PRINTED TANNED BLACK</p>
 <p>78 3/4" (200 cm)</p> <p>11" (28 cm)</p>	<p>D8-4223 SMOOTH BEIGE FLOOR LAMP MAX 150W T10  + 3 MAX 60W MED.  ADA</p>	<p>D8-4224 SMOOTH BLACK</p> <p>D8-4225 SMOOTH RED</p> <p>D8-4226 SMOOTH ORANGE</p> <p>D8-4227 CROCODILE WHITE</p> <p>D8-4228 CROCODILE BLACK</p> <p>D8-4229 CROCODILE RED</p>	<p>D8-4230 CROCODILE ORANGE</p> <p>D8-4231 OSTRICH WHITE</p> <p>D8-4232 OSTRICH BLACK</p> <p>D8-4233 OSTRICH RED</p> <p>D8-4234 OSTRICH FUCSIA</p> <p>D8-4235 OSTRICH GREEN</p>	<p>D8-4236 LEOPARD SILVER</p> <p>D8-4237 LEOPARD GOLD</p> <p>D8-4238 PRINTED TANNED BROWN</p> <p>D8-4239 PRINTED TANNED BLACK</p>

CARRÈ pelle



HANDCRAFT PRODUCT "MADE IN ITALY".
MANUFACTURED IN RECYCLED LEATHER
OBTAINED FROM LEATHER FIBRES, LATEX AND
NATURAL GREASE. RESPECT FOR THE
ENVIRONMENT, FLEXIBILITY, RESISTANCE AND
NATURAL AGING PROCESS ARE THE
FUNDAMENTAL FEATURES THAT MAKE THIS
MATERIAL INNOVATIVE AND AT TOP QUALITY
STANDARDS.

PRODUIT ARTISANAL "MADE IN ITALY", EN CUIR
RÉGÉNÉRÉ: MATÉRIEL COMPOSÉ PAR DE
FIBRES DE CUIR, LATEX ET GRAS NATURELS.
RESPECT POUR L'ENVIRONNEMENT,
FLEXIBILITÉ, RÉSISTANCE ET UN NATUREL
VIEILLISSEMENT SONT LES
CARACTÉRISTIQUES FONDAMENTALES QUI
RENDENT CE MATÉRIEL INNOVANT ET DE
SUPERBE QUALITÉ.

PRODUCTO DE ARTISÁN "MADE IN ITALY".
FABRICADO EN CUERO RECICLADO,
OBTENIDO DE LAS FIBRAS DE CUERO, LÁTEX
Y GRASA NATURAL. EL RESPECTO POR EL
AMBIENTE, LA FLEXIBILIDAD, LA RESISTENCIA
Y EL PROCESO NATURAL DEL
ENVEJECIMIENTO SON LAS CARACTERÍSTICAS
FUNDAMENTALES QUE HACEN ESTE
MATERIAL DINÁMICO Y DE ALTÍSIMA CALIDAD.





CARRÉ pelle

MANUFACTURED IN RECYCLED LEATHER, AN ECOLOGIC MATERIAL OBTAINED FROM LEATHER FIBRES, LATEX AND NATURAL GREASE.

PRODUIT ARTISANAL EN CUIR RÉGÉNÉRÉ: MATÉRIEL ÉCOLOGIQUE, COMPOSÉ PAR DE FIBRES DE CUIR, LATEX ET GRAS NATURELS.

FABRICADO EN CUERO RECICLADO, UN MATERIAL ECOLÓGICO OBTENIDO DE LAS FIBRAS DE CUERO, LÁTEX Y GRASA NATURAL.

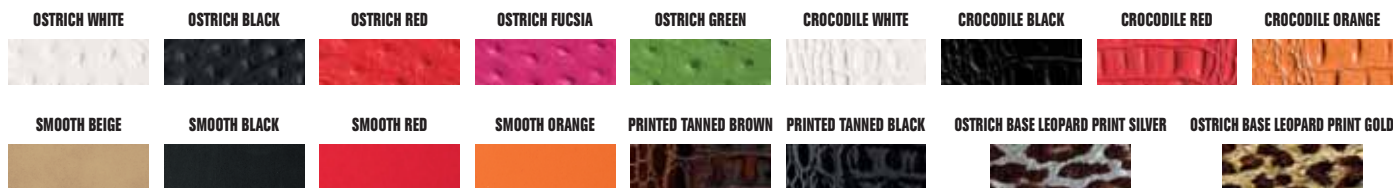

	<p>D8-3108 SMOOTH BEIGE WALL SCONCE MAX 75W MED. ADA</p> <p>D8-3109 SMOOTH BLACK</p> <p>D8-3110 SMOOTH RED</p> <p>D8-3111 SMOOTH ORANGE</p> <p>D8-3112 CROCODILE WHITE</p>	<p>D8-3113 CROCODILE BLACK</p> <p>D8-3114 CROCODILE RED</p> <p>D8-3115 CROCODILE ORANGE</p> <p>D8-3116 OSTRICH WHITE</p> <p>D8-3117 OSTRICH BLACK</p> <p>D8-3118 OSTRICH RED</p>	<p>D8-3119 OSTRICH FUCSIA</p> <p>D8-3120 OSTRICH GREEN</p> <p>D8-3121 LEOPARD SILVER</p> <p>D8-3122 LEOPARD GOLD</p> <p>D8-3123 PRINTED TANNED BROWN</p> <p>D8-3124 PRINTED TANNED BLACK</p>
	<p>D8-4121 SMOOTH BEIGE TABLE LAMP MAX 75W MED. ADA</p> <p>D8-4122 SMOOTH BLACK</p> <p>D8-4123 SMOOTH RED</p> <p>D8-4124 SMOOTH ORANGE</p> <p>D8-4125 CROCODILE WHITE</p>	<p>D8-4126 CROCODILE BLACK</p> <p>D8-4127 CROCODILE RED</p> <p>D8-4128 CROCODILE ORANGE</p> <p>D8-4129 OSTRICH WHITE</p> <p>D8-4130 OSTRICH BLACK</p> <p>D8-4131 OSTRICH RED</p>	<p>D8-4132 OSTRICH FUCSIA</p> <p>D8-4133 OSTRICH GREEN</p> <p>D8-4134 LEOPARD SILVER</p> <p>D8-4135 LEOPARD GOLD</p> <p>D8-4136 PRINTED TANNED BROWN</p> <p>D8-4137 PRINTED TANNED BLACK</p>
	<p>D8-4138 SMOOTH BEIGE FLOOR LAMP MAX 100W MED. ADA</p> <p>D8-4139 SMOOTH BLACK</p> <p>D8-4140 SMOOTH RED</p> <p>D8-4141 SMOOTH ORANGE</p> <p>D8-4142 CROCODILE WHITE</p>	<p>D8-4143 CROCODILE BLACK</p> <p>D8-4144 CROCODILE RED</p> <p>D8-4145 CROCODILE ORANGE</p> <p>D8-4146 OSTRICH WHITE</p> <p>D8-4147 OSTRICH BLACK</p> <p>D8-4148 OSTRICH RED</p>	<p>D8-4149 OSTRICH FUCSIA</p> <p>D8-4150 OSTRICH GREEN</p> <p>D8-4151 LEOPARD SILVER</p> <p>D8-4152 LEOPARD GOLD</p> <p>D8-4153 PRINTED TANNED BROWN</p> <p>D8-4154 PRINTED TANNED BLACK</p>



9 1/2" x 9 1/2"
(24 x 24 cm)

D8-9017

GLASS SCREEN FOR SHADE
ÉCRAN POUR ABAT-JOUR
DEFENSA POR PANTALLA



DEBUT

HANDCRAFT PRODUCT "MADE IN ITALY".
MANUFACTURED IN RECYCLED LEATHER
OBTAINED FROM LEATHER FIBRES, LATEX AND
NATURAL GREASE. RESPECT FOR THE
ENVIRONMENT, FLEXIBILITY, RESISTANCE AND
NATURAL AGING PROCESS ARE THE
FUNDAMENTAL FEATURES THAT MAKE THIS
MATERIAL INNOVATIVE AND AT TOP QUALITY
STANDARDS.

PRODUIT ARTISANAL "MADE IN ITALY", EN CUIR
RÉGÉNÉRÉ: MATÉRIEL COMPOSÉ PAR DE
FIBRES DE CUIR, LATEX ET GRAS NATURELS.
RESPECT POUR L'ENVIRONNEMENT,
FLEXIBILITÉ, RÉSISTANCE ET UN NATUREL
VIEILLISSEMENT SONT LES
CARACTÉRISTIQUES FONDAMENTALES QUI
RENDENT CE MATÉRIEL INNOVANT ET DE
SUPERBE QUALITÉ.

PRODUCTO DE ARTISÁN "MADE IN ITALY".
FABRICADO EN CUERO RECICLADO,
OBTENIDO DE LAS FIBRAS DE CUERO, LÁTEX
Y GRASA NATURAL. EL RESPECTO POR EL
AMBIENTE, LA FLEXIBILIDAD, LA RESISTENCIA
Y EL PROCESO NATURAL DEL
ENVEJECIMIENTO SON LAS CARACTERÍSTICAS
FUNDAMENTALES QUE HACEN ESTE
MATERIAL DINÁMICO Y DE ALTÍSIMA CALIDAD.







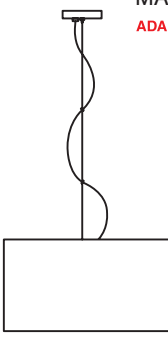

DEBUT

MANUFACTURED IN RECYCLED LEATHER, AN ECOLOGIC MATERIAL OBTAINED FROM LEATHER FIBRES, LATEX AND NATURAL GREASE.

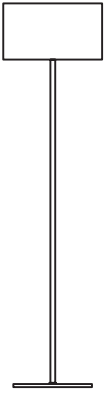
PRODUIT ARTISANAL EN CUIR RÉGÉNÉRÉ: MATÉRIEL ÉCOLOGIQUE, COMPOSÉ PAR DE FIBRES DE CUIR, LATEX ET GRAS NATURELS.

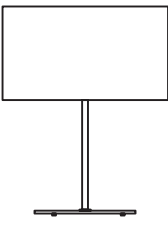
FABRICADO EN CUERO RECICLADO, UN MATERIAL ECOLÓGICO OBTENIDO DE LAS FIBRAS DE CUERO, LÁTEX Y GRASA NATURAL.

 <p>D8-1110 SMOOTH BEIGE PENDANT MAX 150W T10  ADA</p> <p>10" (25 cm)</p> <p>17 1/3" (44 cm)</p>	<p>D8-1111 SMOOTH BLACK</p> <p>D8-1112 SMOOTH RED</p> <p>D8-1113 SMOOTH ORANGE</p> <p>D8-1114 CROCODILE WHITE</p> <p>D8-1115 CROCODILE BLACK</p> <p>D8-1116 CROCODILE RED</p>	<p>D8-1117 CROCODILE ORANGE</p> <p>D8-1118 OSTRICH WHITE</p> <p>D8-1119 OSTRICH BLACK</p> <p>D8-1120 OSTRICH RED</p> <p>D8-1121 OSTRICH FUCSIA</p> <p>D8-1122 OSTRICH GREEN</p>	<p>D8-1123 LEOPARD SILVER</p> <p>D8-1124 LEOPARD GOLD</p> <p>D8-1125 PRINTED TANNED BROWN</p> <p>D8-1126 PRINTED TANNED BLACK</p>
 <p>D8-4189 SMOOTH BEIGE FLOOR LAMP MAX 150W T10  ADA</p> <p>67" (170 cm)</p> <p>17 1/3" (28 cm)</p>	<p>D8-4190 SMOOTH BLACK</p> <p>D8-4191 SMOOTH RED</p> <p>D8-4192 SMOOTH ORANGE</p> <p>D8-4193 CROCODILE WHITE</p> <p>D8-4194 CROCODILE BLACK</p> <p>D8-4195 CROCODILE RED</p>	<p>D8-4196 CROCODILE ORANGE</p> <p>D8-4197 OSTRICH WHITE</p> <p>D8-4198 OSTRICH BLACK</p> <p>D8-4199 OSTRICH RED</p> <p>D8-4200 OSTRICH FUCSIA</p> <p>D8-4201 OSTRICH GREEN</p>	<p>D8-4202 LEOPARD SILVER</p> <p>D8-4203 LEOPARD GOLD</p> <p>D8-4204 PRINTED TANNED BROWN</p> <p>D8-4205 PRINTED TANNED BLACK</p>
 <p>D8-4155 SMOOTH BEIGE TABLE LAMP MAX 150W T10  ADA</p> <p>22 1/2" (57 cm)</p> <p>17 1/3" (44 cm)</p>	<p>D8-4156 SMOOTH BLACK</p> <p>D8-4157 SMOOTH RED</p> <p>D8-4158 SMOOTH ORANGE</p> <p>D8-4159 CROCODILE WHITE</p> <p>D8-4160 CROCODILE BLACK</p> <p>D8-4161 CROCODILE RED</p>	<p>D8-4162 CROCODILE ORANGE</p> <p>D8-4163 OSTRICH WHITE</p> <p>D8-4164 OSTRICH BLACK</p> <p>D8-4165 OSTRICH RED</p> <p>D8-4166 OSTRICH FUCSIA</p> <p>D8-4167 OSTRICH GREEN</p>	<p>D8-4168 LEOPARD SILVER</p> <p>D8-4169 LEOPARD GOLD</p> <p>D8-4170 PRINTED TANNED BROWN</p> <p>D8-4171 PRINTED TANNED BLACK</p>

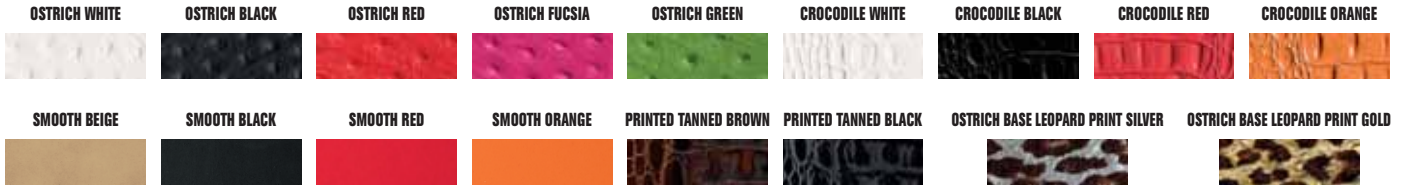

D8-4172

SMOOTH BEIGE
TABLE LAMP
MAX 75W MED. 
ADA

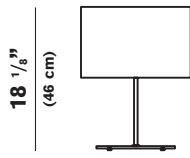

11 3/8"
(29 cm)

D8-4173

SMOOTH BLACK

D8-4174

SMOOTH RED

D8-4175

SMOOTH ORANGE

D8-4176

CROCODILE WHITE

D8-4177

CROCODILE BLACK

D8-4178

CROCODILE RED

D8-4179

CROCODILE ORANGE

D8-4180

OSTRICH WHITE

D8-4181

OSTRICH BLACK

D8-4182

OSTRICH RED

D8-4183

OSTRICH FUCSIA

D8-4184

OSTRICH GREEN

D8-4185

LEOPARD SILVER

D8-4186

LEOPARD GOLD

D8-4187

PRINTED TANNED BROWN

D8-4188

PRINTED TANNED BLACK

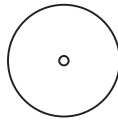

16 1/8"
(41 cm)

D8-9018

GLASS SCREEN FOR SHADE
ÉCRAN POUR ABAT-JOUR
DEFENSA POR PANTALLA

OFFSET

DECENTRAGE - DESCENTRADO



D8-9003
GREY METAL
GRIS METALLISE
GRIS METALIZADO

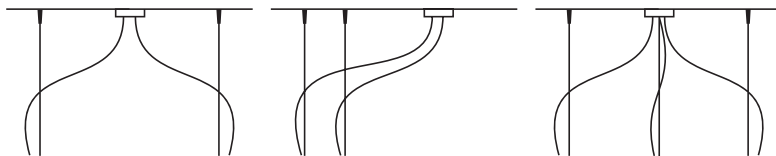

D8-9004
GREY METAL
GRIS METALLISE
GRIS METALIZADO

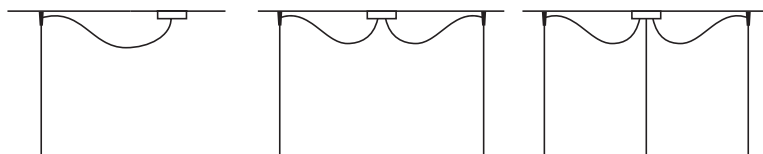

D8-9007
GREY METAL
GRIS METALLISE
GRIS METALIZADO

D8-9008
NICKEL
NICKEL
NÍQUEL

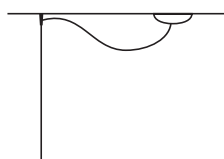

D8-9009
GREY METAL
GRIS METALLISE
GRIS METALIZADO

D8-9010
NICKEL
NICKEL
NÍQUEL

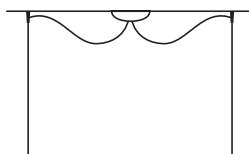

D8-9011
GREY METAL
GRIS METALLISE
GRIS METALIZADO



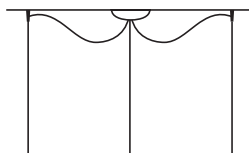



D8-9012
NICKEL
NICKEL
NÍQUEL



LIGHT BULBS

AMPOULES - FOCOS





Halogen 120V

G9	
E12	
E26-T10	
GU10	
GZ10	
R7S-T3Q (119 mm)	
R7S-T3Q/3 (79 mm)	







Halogen 12V

GY6.35	
--------	---

Incandescent

E12 - G16 1/2 Candelabra	
E12-B10 Candelabra	
E26 Medium	
E26 Chrome Bottom	
G16 1/2; G25; G30 Medium	

Compact Fluorescent

G24 Q3; G24 D3	
2G11	
G24 Q2	
E26 Dulux EL Longlife	
T5 Circline	
HQI	

BRANDS

MARQUES - MARCAS



Approved by CSA for CANADIAN & US Safety Standards.

ADA

The Americans with Disabilities Act.



Fixture meets standard EN 60598-1.
Luminaires selon standard EN 60598-1.
Lampára correspondiente a la norma EN 60598-1



The Italian Quality Mark Institute is an official body to guarantee and check that all equipment conforms with EC norms (34-21).
Le marque de qualité italien IMQ garantit la conformité des appareils aux normes CE (34-21).
Istituto del "Marchio Italiano di Qualità" IMQ es organo autorizado que garantiza y controla que les lamparas eran conforme a la norma CE (34-21).



Low-energy consumption bulbs can be fitted.
Il est possible d'installer des ampoules à faible consommation d'énergie.
Posibilidad de instalar lamparas de bajo consumo.



The fixture can be applied on surfaces normally inflammable.
Lampe qui peut être installée surfaces normalment infiammables.
Aparado para ser instalado en superficies normalmente inflamables.



Fixture class II.
Luminaire classe II.
Aparado de clase II.



Fixture class III
Luminaire classe III
Aparado de clase III

IP20

Index protection.
Degré de protection.
Grado di protección.

ACCESSORY

WHITE OR METALLIZED GRAY TRACK WITH SPECIAL POLYCARBONATE STRIPS TO COVER HOLES. ADJUSTABLE FOR VARIOUS SERIES OF OUR COLLECTIONS.

BARRE EN BLANC OU GRIS MÉTALLISÉ AVEC BAGUETTES SPÉCIALES EN POLYCARBONATE CACHE ADAPTABLE À DIFFÉRENTS MODÈLES DANS NOTRE CATALOGUE.

BARRA EN BLANCO O GRIS METALIZADO CON LISTAS ESPECIALES DE POLICARBONATO CUBRE AGUJEROS ADAPTABLE A DIVERSOS MODELOS DE NUESTRO CATÁLOGO.

 <p>CE</p>	<p>ITEMS CAN BE MATCHED TO D8-9013 OR D8-9014 WITH D8-9015 DETAIL</p> <p>ARTICLES COMBINABLES AVEC D8-9013 OU D8-9014 AVEC ACCESSOIRE D8-9015</p> <p>ARTÍCULOS COMBINABLES CON D8-9013 O D8-9014 CON DETALLE D8-9015</p>	 <p>BLUES</p>	 <p>DOMINO</p>	 <p>JAZZ</p>	 <p>MINE</p>	 <p>WAVE</p>	 <p>TOURBILLON</p>	 <p>FLORAL</p>
 <p>CA</p>	<p>ITEMS CAN BE MATCHED TO D8-9013 OR D8-9014 WITH D8-9016 DETAIL</p> <p>ARTICLES COMBINABLES AVEC D8-9013 OU D8-9014 AVEC ACCESSOIRE D8-9016</p> <p>ARTÍCULOS COMBINABLES CON D8-9013 O D8-9014 CON DETALLE D8-9016</p>	 <p>ALVI</p>	 <p>BLOW</p>	 <p>BLOW MINI</p>	 <p>DELPHINA</p>	 <p>DENIS</p>		
		 <p>SPYRA</p>	 <p>TWISTER</p>	 <p>WILLY.40</p>	 <p>WILLY</p>			

D8-9013 D8-9014

2 3/4"
(6 cm)

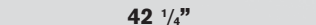
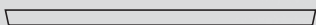

42 1/4"
(120 cm)

TO BE ORDERED WITH D8-9015 OR D8-9016 DETAILS
A ORDONNER AVEC DES ACCESSOIRES D8-9015 OU D8-9016
DE ORDENAR CON ACCESORIOS D8-9015 O D8-9016

INDEX

NUMERICAL ORDER

INDEX - INDEX

D8-1017	37	D8-1134	65	D8-3082	60	D8-4134	69	D8-4206	65
D8-1018	37	D8-1135	65	D8-3095	26	D8-4135	69	D8-4207	65
D8-1019	37	D8-1136	64	D8-3096	26	D8-4136	69	D8-4208	65
D8-1045	46	D8-1137	63	D8-3098	59	D8-4137	69	D8-4209	65
D8-1046	46	D8-1138	63	D8-3099	59	D8-4138	69	D8-4210	65
D8-1047	46	D8-1139	63	D8-3100	60	D8-4139	69	D8-4211	65
D8-1048	46	D8-1140	65	D8-3101	47	D8-4140	69	D8-4212	65
D8-1048	46	D8-1141	65	D8-3102	47	D8-4141	69	D8-4213	65
D8-1049	46	D8-1142	65	D8-3103	47	D8-4142	69	D8-4214	65
D8-1049	46	D8-1143	65	D8-3104	47	D8-4143	68	D8-4215	65
D8-1050	46	D8-1144	32	D8-3105	38	D8-4144	68	D8-4216	65
D8-1071	37	D8-1145	37	D8-3106	38	D8-4145	69	D8-4217	65
D8-1072	37	D8-1146	32	D8-3107	38	D8-4146	69	D8-4218	64
D8-1073	37	D8-1147	37	D8-3108	69	D8-4147	69	D8-4219	65
D8-1074	7	D8-1148	37	D8-3109	69	D8-4148	69	D8-4220	65
D8-1075	6	D8-2033	46	D8-3110	69	D8-4149	69	D8-4221	65
D8-1076	5	D8-2034	46	D8-3111	69	D8-4150	69	D8-4222	65
D8-1077	56	D8-2035	46	D8-3112	66	D8-4151	69	D8-4223	65
D8-1078	54	D8-2036	46	D8-3113	69	D8-4152	69	D8-4224	65
D8-1079	56	D8-2037	46	D8-3114	69	D8-4153	69	D8-4225	65
D8-1080	54	D8-2038	46	D8-3115	69	D8-4154	69	D8-4226	64
D8-1083	46	D8-2039	48	D8-3116	69	D8-4155	72	D8-4227	65
D8-1084	46	D8-2040	48	D8-3117	69	D8-4156	72	D8-4228	65
D8-1085	21	D8-2041	48	D8-3118	69	D8-4157	72	D8-4229	65
D8-1086	21	D8-2042	48	D8-3119	69	D8-4158	72	D8-4230	65
D8-1087	18	D8-2043	48	D8-3120	69	D8-4159	72	D8-4231	65
D8-1088	21	D8-2044	48	D8-3121	69	D8-4160	72	D8-4232	65
D8-1089	21	D8-2045	49	D8-3122	69	D8-4161	72	D8-4233	65
D8-1090	21	D8-2046	49	D8-3123	69	D8-4162	72	D8-4234	65
D8-1091	21	D8-2047	49	D8-3124	69	D8-4163	72	D8-4235	65
D8-1092	21	D8-2057	8	D8-4079	47	D8-4164	72	D8-4236	65
D8-1093	18	D8-2058	9	D8-4080	47	D8-4165	72	D8-4237	65
D8-1094	19	D8-2059	50	D8-4081	47	D8-4166	72	D8-4238	65
D8-1095	21	D8-2060	52	D8-4082	49	D8-4167	72	D8-4239	65
D8-1096	21	D8-2061	50	D8-4083	49	D8-4168	72	D8-9003	74
D8-1097	21	D8-2062	46	D8-4084	49	D8-4169	72	D8-9004	74
D8-1098	21	D8-2063	46	D8-4093	12	D8-4170	72	D8-9007	74
D8-1099	21	D8-2064	46	D8-4094	12	D8-4171	71	D8-9008	74
D8-1100	37	D8-2065	46	D8-4095	14	D8-4172	73	D8-9009	74
D8-1101	37	D8-2066	48	D8-4096	10	D8-4173	73	D8-9010	74
D8-1102	37	D8-2067	48	D8-4097	47	D8-4174	73	D8-9011	74
D8-1103	37	D8-2068	48	D8-4098	47	D8-4175	73	D8-9012	74
D8-1104	37	D8-2069	48	D8-4099	49	D8-4176	73	D8-9017	69
D8-1105	22	D8-2070	49	D8-4100	49	D8-4177	73	D8-9018	73
D8-1106	24	D8-2071	49	D8-4101	20	D8-4178	73		
D8-1107	23	D8-2072	42	D8-4102	21	D8-4179	73		
D8-1108	37	D8-2073	41	D8-4103	21	D8-4180	71		
D8-1109	37	D8-2074	44	D8-4104	21	D8-4181	73		
D8-1110	72	D8-2075	40	D8-4105	21	D8-4182	73		
D8-1111	72	D8-2076	38	D8-4111	39	D8-4183	73		
D8-1112	72	D8-2077	38	D8-4112	39	D8-4184	73		
D8-1113	72	D8-2078	30	D8-4113	36	D8-4185	73		
D8-1114	72	D8-2079	38	D8-4114	39	D8-4186	73		
D8-1115	72	D8-2080	38	D8-4115	39	D8-4187	73		
D8-1116	72	D8-2081	34	D8-4116	39	D8-4188	73		
D8-1117	72	D8-2082	28	D8-4117	27	D8-4189	72		
D8-1118	72	D8-2083	35	D8-4118	39	D8-4190	72		
D8-1119	72	D8-2084	38	D8-4119	39	D8-4191	72		
D8-1120	72	D8-2085	38	D8-4120	39	D8-4192	72		
D8-1121	72	D8-2086	38	D8-4121	69	D8-4193	72		
D8-1122	72	D8-2087	38	D8-4122	69	D8-4194	72		
D8-1123	70	D8-2088	28	D8-4123	69	D8-4195	72		
D8-1124	70	D8-2089	29	D8-4124	69	D8-4196	72		
D8-1125	72	D8-2090	38	D8-4125	69	D8-4197	72		
D8-1126	72	D8-3068	47	D8-4126	69	D8-4198	72		
D8-1127	65	D8-3069	47	D8-4127	69	D8-4199	72		
D8-1128	65	D8-3070	47	D8-4128	67	D8-4200	72		
D8-1129	65	D8-3071	47	D8-4129	69	D8-4201	72		
D8-1130	65	D8-3072	47	D8-4130	69	D8-4202	72		
D8-1131	65	D8-3073	47	D8-4131	69	D8-4203	72		
D8-1132	65	D8-3080	59	D8-4132	69	D8-4204	71		
D8-1133	65	D8-3081	59	D8-4133	69	D8-4205	72		

INDEX

ALPHABETICAL ORDER

INDEX - INDEX

ACCESSORY	pag. 77	D8-1112	72	D8-1083	46	OFFSET	pag. 74	D8-4228	65
		D8-1113	72	D8-1084	46	D8-9003	74	D8-4229	65
ALL STARS	pag. 58	D8-1114	72	D8-2033	46	D8-9004	74	D8-4230	65
D8-3098	59	D8-1115	72	D8-2034	46	D8-9007	74	D8-4231	65
D8-3080	59	D8-1116	72	D8-2035	46	D8-9008	74	D8-4232	65
D8-3099	59	D8-1117	72	D8-2062	46	D8-9009	74	D8-4233	65
D8-3081	59	D8-1118	72	D8-2063	46	D8-9010	74	D8-4234	65
D8-3100	60	D8-1119	72	D8-2036	46	D8-9011	74	D8-4235	65
D8-3082	60	D8-1120	72	D8-2037	46	D8-9012	74	D8-4236	65
		D8-1121	72	D8-2038	46			D8-4237	65
CARRÈ PELLE	pag. 66	D8-1122	72	D8-2064	46	RING	pag. 18	D8-4238	65
D8-3112	66	D8-1125	72	D8-2065	46	D8-1087	18	D8-4239	65
D8-4128	67	D8-1126	72	D8-3068	47	D8-1093	18		
D8-4143	68	D8-4189	72	D8-3069	47	D8-1094	19	TOURBILLON	pag. 22
D8-4144	68	D8-4190	72	D8-3070	47	D8-4101	20	D8-1105	22
D8-3108	69	D8-4191	72	D8-3101	47	D8-1085	21	D8-1107	23
D8-3109	69	D8-4192	72	D8-3102	47	D8-1086	21	D8-1106	24
D8-3110	69	D8-4193	72	D8-3071	47	D8-1088	21	D8-3095	26
D8-3111	69	D8-4194	72	D8-3072	47	D8-1089	21	D8-3096	26
D8-3113	69	D8-4195	72	D8-3073	47	D8-1090	21	D8-4117	27
D8-3114	69	D8-4196	72	D8-3103	47	D8-1091	21	D8-2082	28
D8-3115	69	D8-4197	72	D8-3104	47	D8-1092	21	D8-2088	28
D8-3116	69	D8-4198	72	D8-4079	47	D8-1095	21	D8-2089	29
D8-3117	69	D8-4199	72	D8-4080	47	D8-1096	21	D8-2078	30
D8-3118	69	D8-4200	72	D8-4081	47	D8-1097	21	D8-1144	32
D8-3119	69	D8-4201	72	D8-4097	47	D8-1098	21	D8-1146	32
D8-3120	69	D8-4202	72	D8-4098	47	D8-1099	21	D8-2081	34
D8-3121	69	D8-4203	72	D8-2039	48	D8-4102	21	D8-2083	35
D8-3122	69	D8-4205	72	D8-2040	48	D8-4103	21	D8-1145	37
D8-3123	69	D8-4155	72	D8-2041	48	D8-4104	21	D8-1147	37
D8-3124	69	D8-4156	72	D8-2066	48	D8-4105	21	D8-1148	37
D8-4121	69	D8-4157	72	D8-2067	48			D8-1071	37
D8-4122	69	D8-4158	72	D8-2042	48	SNAKE	pag. 62	D8-1017	37
D8-4123	69	D8-4159	72	D8-2043	48	D8-1137	63	D8-1073	37
D8-4124	69	D8-4160	72	D8-2044	48	D8-1138	63	D8-1018	37
D8-4125	69	D8-4161	72	D8-2068	48	D8-1139	63	D8-1072	37
D8-4126	69	D8-4162	72	D8-2069	48	D8-1136	64	D8-1019	37
D8-4127	69	D8-4163	72	D8-4082	49	D8-4218	64	D8-1100	37
D8-4129	69	D8-4164	72	D8-4083	49	D8-4226	64	D8-1101	37
D8-4130	69	D8-4165	72	D8-4084	49	D8-1127	65	D8-1102	37
D8-4131	69	D8-4166	72	D8-4099	49	D8-1128	65	D8-1103	37
D8-4132	69	D8-4167	72	D8-4100	49	D8-1129	65	D8-1104	37
D8-4133	69	D8-4168	72	D8-2045	49	D8-1130	65	D8-1108	37
D8-4134	69	D8-4169	72	D8-2046	49	D8-1131	65	D8-1109	37
D8-4135	69	D8-4170	72	D8-2047	49	D8-1132	65	D8-2076	38
D8-4136	69	D8-4172	73	D8-2047	49	D8-1133	65	D8-2077	38
D8-4137	69	D8-4173	73	D8-2070	49	D8-1134	65	D8-2079	38
D8-4138	69	D8-4174	73	D8-2071	49	D8-1135	65	D8-2080	38
D8-4139	69	D8-4175	73			D8-1140	65	D8-2080	38
D8-4140	69	D8-4176	73	DOMINO INOX	pag. 40	D8-1141	65	D8-3105	38
D8-4141	69	D8-4177	73	D8-2075	40	D8-1142	65	D8-3106	38
D8-4142	69	D8-4178	73	D8-2073	41	D8-1143	65	D8-3107	38
D8-4145	69	D8-4179	73	D8-2072	42	D8-4206	65	D8-2084	38
D8-4146	69	D8-4181	73	D8-2074	44	D8-4207	65	D8-2085	38
D8-4147	69	D8-4182	73			D8-4208	65	D8-2086	38
D8-4148	69	D8-4183	73	FLAN	pag. 50	D8-4209	65	D8-2087	38
D8-4149	69	D8-4184	73	D8-2059	50	D8-4210	65	D8-2090	38
D8-4150	69	D8-4185	73	D8-2061	50	D8-4211	65	D8-4111	39
D8-4151	69	D8-4186	73	D8-2060	52	D8-4212	65	D8-4112	39
D8-4152	69	D8-4187	73			D8-4213	65	D8-4113	36
D8-4153	69	D8-4188	73	FLORAL	pag. 4	D8-4214	65	D8-4114	39
D8-4154	69	D8-9018	73	D8-1076	5	D8-4215	65	D8-4115	39
D8-9017	69			D8-1075	6	D8-4216	65	D8-4116	39
		DOMINO	pag. 46	D8-1074	7	D8-4217	65	D8-4118	39
DEBUT	pag. 70	D8-1045	46	D8-2057	8	D8-4219	65	D8-4119	39
D8-1123	70	D8-1046	46	D8-2058	9	D8-4220	65	D8-4120	39
D8-1124	70	D8-1047	46	D8-4096	10	D8-4221	65		
D8-4171	71	D8-1048	46	D8-4093	12	D8-4222	65	WILLY 100	pag. 54
D8-4180	71	D8-1049	46	D8-4094	12	D8-4223	65	D8-1077	56
D8-4204	71	D8-1048	46	D8-4095	14	D8-4224	65	D8-1078	54
D8-1110	72	D8-1049	46			D8-4225	65	D8-1079	56
D8-1111	72	D8-1050	46			D8-4227	65	D8-1080	54

GENERAL
CATALOG

D8



ZANEEN

DECORATIVE



LIGHTING-DESIGN

LUMIERE-DESIGN

LUZ-DESIGN

INDEX

TOURBILLON**4**, DOMINO**8**, SHADOW**20**, ALL STARS**24**, BOLLARD**32**, TWISTER**38**, KUBIK**46**, BLOW**54**, BLOW MINI**60**, ALVI**66**, DELPHINA**74**, DENIS**80**, DISCO**86**, TECLA**88**, LIBRA**98**, LUCILLA**104**, NOA**110**, SPYRA**112**, ZENITH**118**, WILLY**126**, MINE**138**, WAVE**144**, BIRNE**152**, CANDLE**154**, JAZZ**158**, BLUES**166**, TU-B**178**, WING**188**, WING MINI**192**, GLIM**198**, GLIM MINI**205**, LOOP**206**, PLANET**212**, BLISSY**216**, CLASSIC**224**, CARRÉ**232**, PICTURE LIGHTS**236**, OFFSET**240**, LIGHTS BULBS**241**, BRANDS **242**, ACCESSORY**243**, INDEX**244**



ENZO PANZERI 2006

TOURBILLON

HARMONY, MOVEMENT AND COLOR,
TOURBILLON IS THE IDEAL
IMAGINATIVE TOUCH TO BRIGHTEN
UP ANY ROOM. A TOUCH OF LIVELY
CREATIVITY THAT TURNS ON THE
PLEASURE OF THE HOME.

HARMONIE, MOUVEMENT, COULEUR.
TOURBILLON INCARNE UNE NOTE
DE FANTASIE IDÉALE POUR
RANIMER LES INTÉRIEURS LES PLUS
VARIÉS. UNE TOUCHE DE CRÉATIVITÉ
PLEINE DE BRIO QUI RAVIVE LE
PLAISIR D'HABITER UN ESPACE.

ARMONÍA, MOVIMIENTO, COLOR.
TURBILLON REPRESENTA UNA NOTA
DE FANTASÍA IDEAL PARA REAVIVAR
LOS AMBIENTES MÁS DIVERSOS. UN
TOQUE DE CREATIVIDAD VIVAZ, QUE
ENCIENDE EL PLACER DE HABITAR.





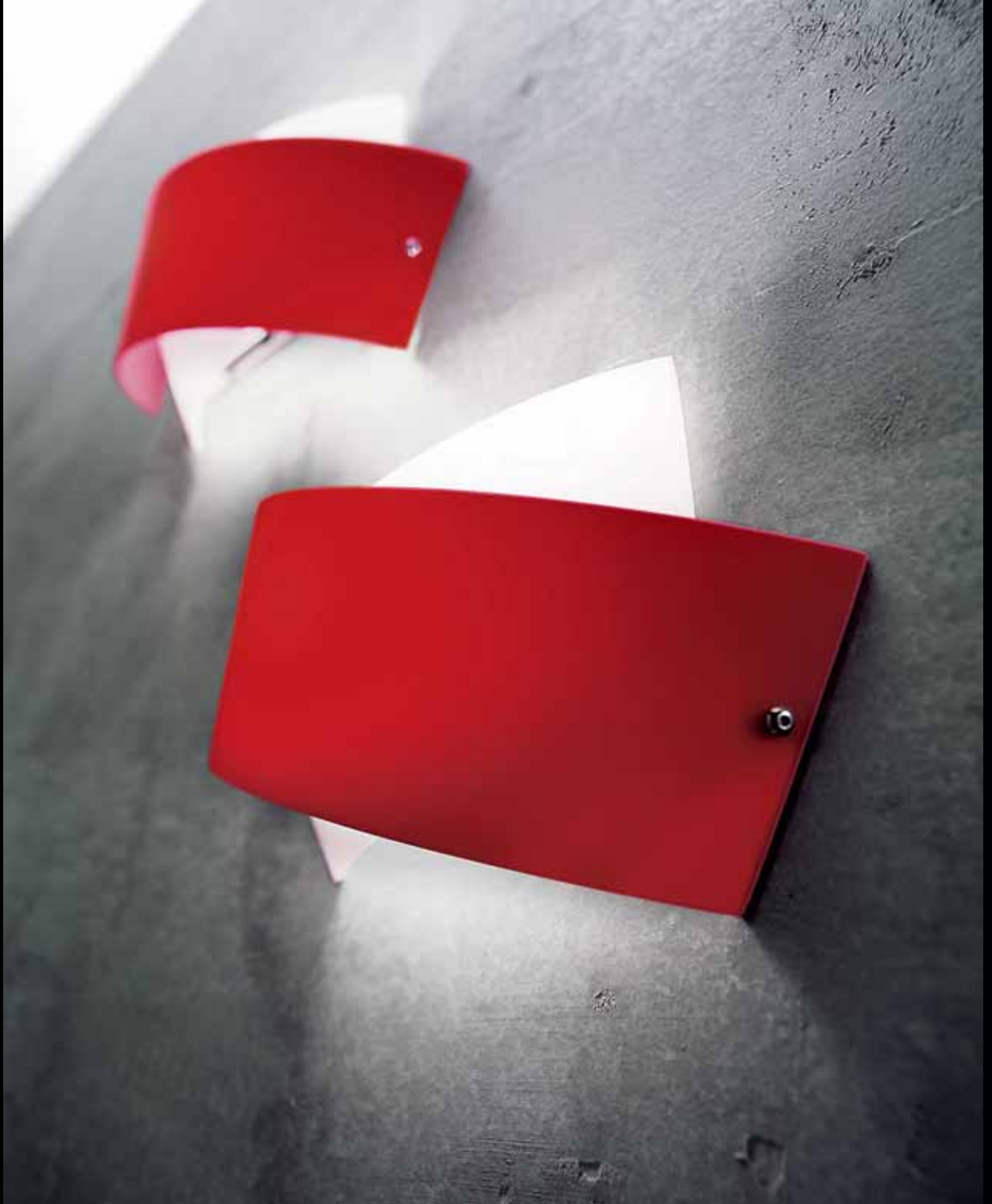

TOURBILLON



TOURBILLON

ENZO PANZERI

PENDANT AND WALL LAMP IN
WHITE WITH NICKEL DETAILS
AND BLOWN GLASS DIFFUSERS.

LAMPES SUSPENSIONS ET
APPLIQUES EN VERRE SOUFFLÉ.
MONTURE EN MÉTAL BLANC
AVEC DÉTAILS EN NICKEL.

LÁMPARA DE SUSPENSIÓN Y DE
PARED EN VIDRIO SOPLADO.
MONTURA DE METAL BLANCO
CON DETALLES NIQUELADOS..

<p>D8-1068 WHITE/WHITE</p> <p>D8-1067 WHITE/RED PENDANT MAX 150W E26</p>	<p>D8-3096 WHITE/WHITE</p> <p>D8-3095 WHITE/RED WALL SCONCE MAX 100W T3Q/3 (79 mm) ADA</p>
--	---

YOHJI TERAZERI 2005

DOMINO

MODELLO DEPOSITATO
PATENT PENDING

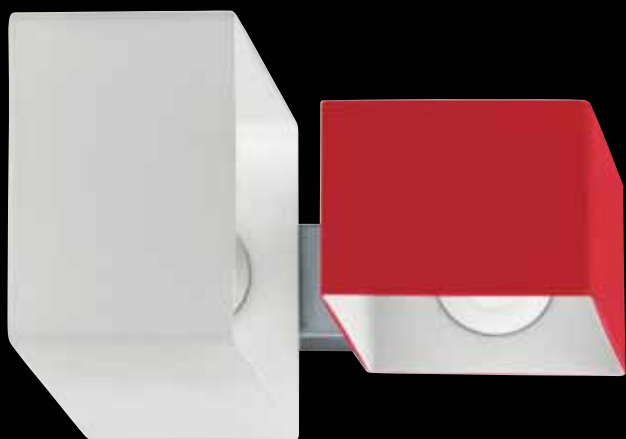

LOGIC AND AESTHETICS
GIVE LIFE TO CONTEMPORARY
SHAPES AND FORMS:
LIGHT ILLUMINATES THE
SURROUNDINGS WITH
PRESENCE AND PERSONALITY.

LOGIQUE ET ESTHETIQUE
CONTRIBUENT A CREER
LES FORMES DE LA
CONTEMPORANEITE: AINSI
LA LUMIERE S'IMPOSE DANS
L'ESPACE PAR SA PRESENCE
ET SA PERSONNALITE.

LÓGICA Y ESTÉTICA
CONSTRIBUYEN A CREAR
LAS FORMAS DE LA
CONTEMPORANEIDAD: ASI
LA LUZ SE IMPONE EN EL
ESPACIO CON PRESENCIA
Y PERSONALIDAD.











DOMINO

A DISCERNING DESIGN GIVES
NEW MEANING TO ELEGANCE.

UN STYLE SOBRE OUVRE DE
NOUVEAUX HORIZONS A L'ELEGANCE.

UN ESTILO AUSTERO ABRE NUEVOS
HORIZONTES A LA ELEGANCIA.





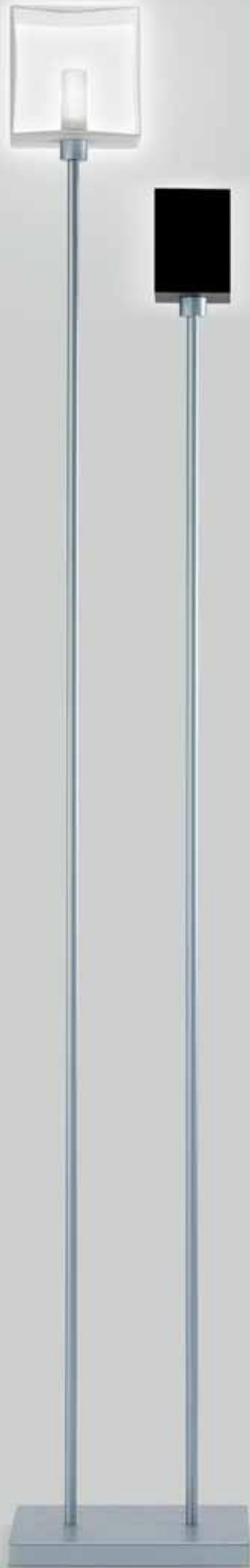



DOMINO

SENSATIONS FLOW FROM
BALANCED LINES WHICH EXPRESS
A NEW CONCEPT OF HARMONY.

L'EMOTION JAILLIT D'UN
EQUILIBRE DE LIGNES QUI
SAIT EXPRIMER UNE NOUVELLE
CONCEPTION DE L'HARMONIE.

LA EMOCIÓN SURGE DE UN
EQUILIBRIO DE LÍNEAS QUE
SABE EXPRESAR UNA NUEVA
CONCEPCIÓN DE LA ARMONÍA.

DOMINO

YOHJI TERAZERI

PENDANTS, WALL/CEILING, TABLE, FLOOR LAMP IN METALLIZED GREY METAL. BLOWN WHITE MATTE GLASS OR BLACK OR RED. IN MULTIPLE SHADE VERSIONS (FLOOR AND WALL/CEILING LAMP) AVAILABLE COMBINATIONS ARE WHITE/WHITE, WHITE/BLACK OR WHITE/RED.

SUSPENSIONS, LAMPE AU SOL, DE TABLE ET APPLIQUE / PLAFONNIERS EN GRIS MÉTALLISÉ. VERRE SOUFFLÉ BLANC SATINÉ OU NOIR OU ROUGE. COMBINAISON DE COULEURS POUR LAMPE AU SOL ET APPLIQUE/PLAFONNIERS SONT BLANC/BLANC OU BLANC/NOIR OU BLANC/ROUGE.

LÁMPARA DE SUELO, DE MESA, DE PARED/PLAFONES Y SUSPENSIONES EN GRIS METALIZADO. VIDRIO SOPLADO BLANCO SATINADO O ROJO O NEGRO. COMBINACIÓN DE COLORES POR LÁMPARA DE SUELO, DE PARED/PLAFONES SON BLANCO/BLANCO O BLANCO/NEGRO O BLANCO/ROJO.

ITEMS WITH SINGLE GLASS:

WHITE

BLACK

RED

LAMPES AVEC UN SEUL VERRE:
LÁMPARAS CON UNO VIDRIO:



<p>D8-1045 WHITE</p> <p>D8-1046 BLACK</p> <p>D8-1047 RED PENDANT MAX 75W G9</p> <p>10 1/4" (26 cm)</p> <p>4 3/8" (11 cm)</p> <p>3 1/8" (8 cm)</p>	<p>D8-1048 WHITE</p> <p>D8-1049 BLACK</p> <p>D8-1050 RED PENDANT MAX 75W G9</p> <p>11 3/8" (29 cm)</p> <p>5 1/2" (14 cm)</p> <p>3 1/2" (9 cm)</p>
<p>D8-2033 WHITE</p> <p>D8-2034 BLACK</p> <p>D8-2035 RED PENDANT HOLDER MAX 75W G9</p> <p>5 1/4" (13 cm)</p> <p>4 3/8" (11 cm)</p> <p>3 1/8" (8 cm)</p>	<p>D8-2036 WHITE</p> <p>D8-2037 BLACK</p> <p>D8-2038 RED PENDANT HOLDER MAX 75W G9</p> <p>6 1/4" (16 cm)</p> <p>5 1/2" (14 cm)</p> <p>3 1/2" (9 cm)</p>

DOMINO

YOHJI TERAZERI

ITEMS WITH SINGLE GLASS:

WHITE

BLACK

RED

LAMPES AVEC UN SEUL VERRE:
LÁMPARAS CON UNO VIDRIO:



D8-3068

WHITE

D8-3069

BLACK

D8-3070

RED

WALL SCNCE
MAX 75W G9
ADA 

$5 \frac{1}{8}''$
(13 cm)



$4 \frac{3}{8}''$
(11 cm)

$3 \frac{1}{2}''$
(9 cm)

D8-3071

WHITE

D8-3072

BLACK

D8-3073

RED

WALL SCNCE
MAX 75W G9
ADA 

$6 \frac{1}{4}''$
(16 cm)

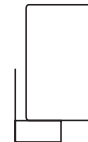
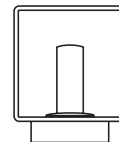

$5 \frac{1}{2}''$
(14 cm)

$3 \frac{7}{8}''$
(10 cm)

D8-4079

WHITE

D8-4080

BLACK

D8-4081

RED

WALL SCNCE
MAX 75W G9

$5 \frac{1}{8}''$
(13 cm)



$4 \frac{3}{8}''$
(11 cm)

$3 \frac{1}{8}''$
(8 cm)

DOMINO

YOHJI TERAZERI

PENDANTS, WALL/CEILING, TABLE, FLOOR LAMP IN METALLIZED GREY METAL. BLOWN WHITE MATTE GLASS OR BLACK OR RED. IN MULTIPLE SHADE VERSIONS (FLOOR AND WALL/CEILING LAMP) AVAILABLE COMBINATIONS ARE WHITE/WHITE, WHITE/BLACK OR WHITE/RED.

SUSPENSIONS, LAMPE AU SOL, DE TABLE ET APPLIQUE / PLAFONNIERS EN GRIS MÉTALLISÉ. VERRE SOUFFLÉ BLANC SATINÉ OU NOIR OU ROUGE. COMBINAISON DE COULEURS POUR LAMPE AU SOL ET APPLIQUE/PLAFONNIERS SONT BLANC/BLANC OU BLANC/NOIR OU BLANC/ROUGE.

LÁMPARA DE SUELO, DE MESA, DE PARED/PLAFONES Y SUSPENSIONES EN GRIS METALIZADO. VIDRIO SOPLADO BLANCO SATINADO O ROJO O NEGRO. COMBINACIÓN DE COLORES POR LÁMPARA DE SUELO, DE PARED/PLAFONES SON BLANCO/BLANCO O BLANCO/NEGRO O BLANCO/ROJO.

ITEMS WITH MULTIPLE GLASSES.

LAMPES AVEC PLUSIEURS VERRES.
LÁMPARAS CON VARIOS VIDRIOS.

**WHITE/WHITE
W/W**



**WHITE/BLACK
W/B**

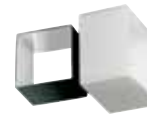

**WHITE/RED
W/R**



D8-2039
WHITE/WHITE

D8-2040
WHITE/BLACK

D8-2041
WHITE/RED
PENDANT HOLDER
MAX 2x75W G9

D8-2042
WHITE/WHITE

D8-2043
WHITE/BLACK

D8-2044
WHITE/RED
PENDANT HOLDER
MAX 4x75W G9

6 1/4"
(16 cm)

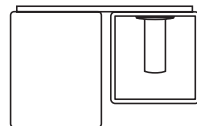
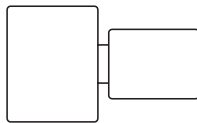

9"
(23 cm)

CAN BE MOUNTED AS A WALL LAMP
UTILISABLE COME APPLIQUE - UTILIZABLE DA PARED

11"
(28 cm)

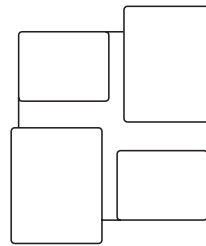

6 1/4"
(16 cm)

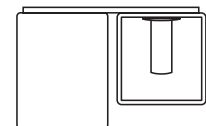

9 1/2"
(24 cm)

CAN BE MOUNTED AS A WALL LAMP
UTILISABLE COME APPLIQUE - UTILIZABLE DA PARED

DOMINO

YOHJI TERAZERI

ITEMS WITH MULTIPLE GLASSES.

LAMPES AVEC PLUSIEURS VERRES.
LÁMPARAS CON VARIOS VIDRIOS.

WHITE/WHITE
W/W



WHITE/BLACK
W/B

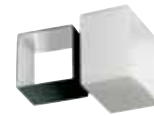

WHITE/RED
W/R



D8-4082
WHITE/WHITE



65"
(165 cm)

D8-4083
WHITE/BLACK

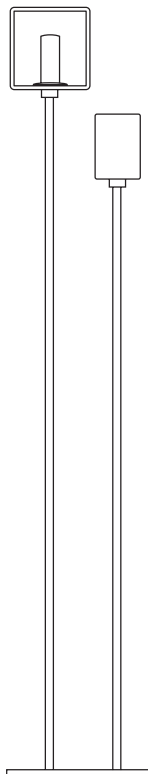

9 1/8"
(25 cm)

D8-4084
WHITE/RED
FLOOR LAMP
MAX 2x75W G9



D8-2045
WHITE/WHITE

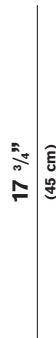

17 3/4"
(45 cm)

7 1/2"
(19 cm)

D8-2046
WHITE/BLACK

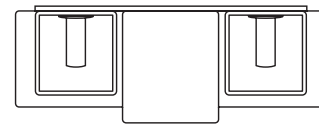
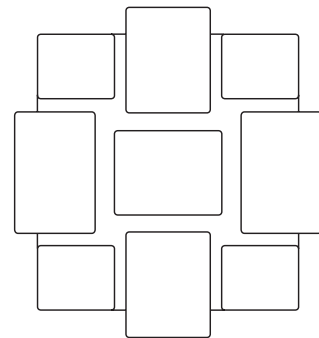

16 7/8"
(43 cm)

D8-2047
WHITE/RED
PENDANT HOLDER
MAX 9x40W G9



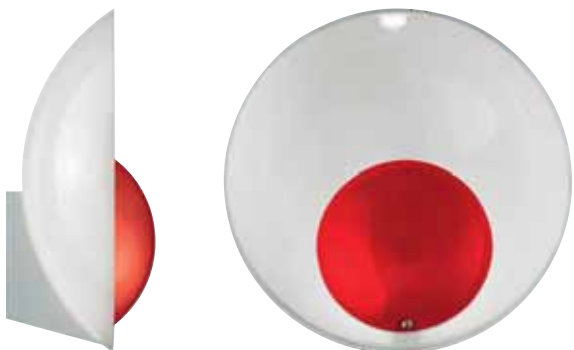

HIGHLIGHT 2006

SHADOW

WALL LAMP IN BLOWN GLASS
WITH WHITE METAL FITTINGS.

APPLIQUE EN VERRE
SOUFFLÉ. MONTURE EN
MÉTAL BLANC.

LÁMPARA DE PARED DE
VIDRIO SOPLADO. MONTURA
DE METAL BLANCO.

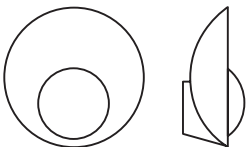
<p>D8-3093 WHITE/RED</p>	<p>D8-3094 WHITE/WHITE WALL SCONCE MAX 75W G9 ADA </p>
<p>$8 \frac{5}{8}''$ (22 cm)</p>	
<p>$8 \frac{5}{8}''$ (22 cm)</p>	<p>$3 \frac{1}{8}''$ (8 cm)</p>

WHITE/RED
W/R



WHITE/WHITE
W/W





ENZO PANZERI 2005

ALL STARS

COLOR, WARMTH AND A PINCH OF IRONY HAVE GIVEN LIFE TO NEW LIGHTING SOLUTIONS IN A PERSPECTIVE OF PERFECT HARMONY BETWEEN ELEGANCE AND CREATIVITY.

COULEUR, CHALEUR ET UNE PINCEE D'IRONIE SONT LES ELEMENTS QUI CREENT DE NOUVELLES SOLUTIONS D'ECLAIRAGE. DANS UN CADRE D'HARMONIE PARFAITE ENTRE ELEGANCE ET CREATIVITE.

COLOR, CALOR Y UNA PIZCA DE IRONIA SON LOS ELEMENTOS QUE DAN VIDA A NUEVAS SOLUCIONES DE LUZ. EN UN CUADRO DE PERFECTA ARMONIA ENTRE ELEGANCIA Y CREATIVIDAD.



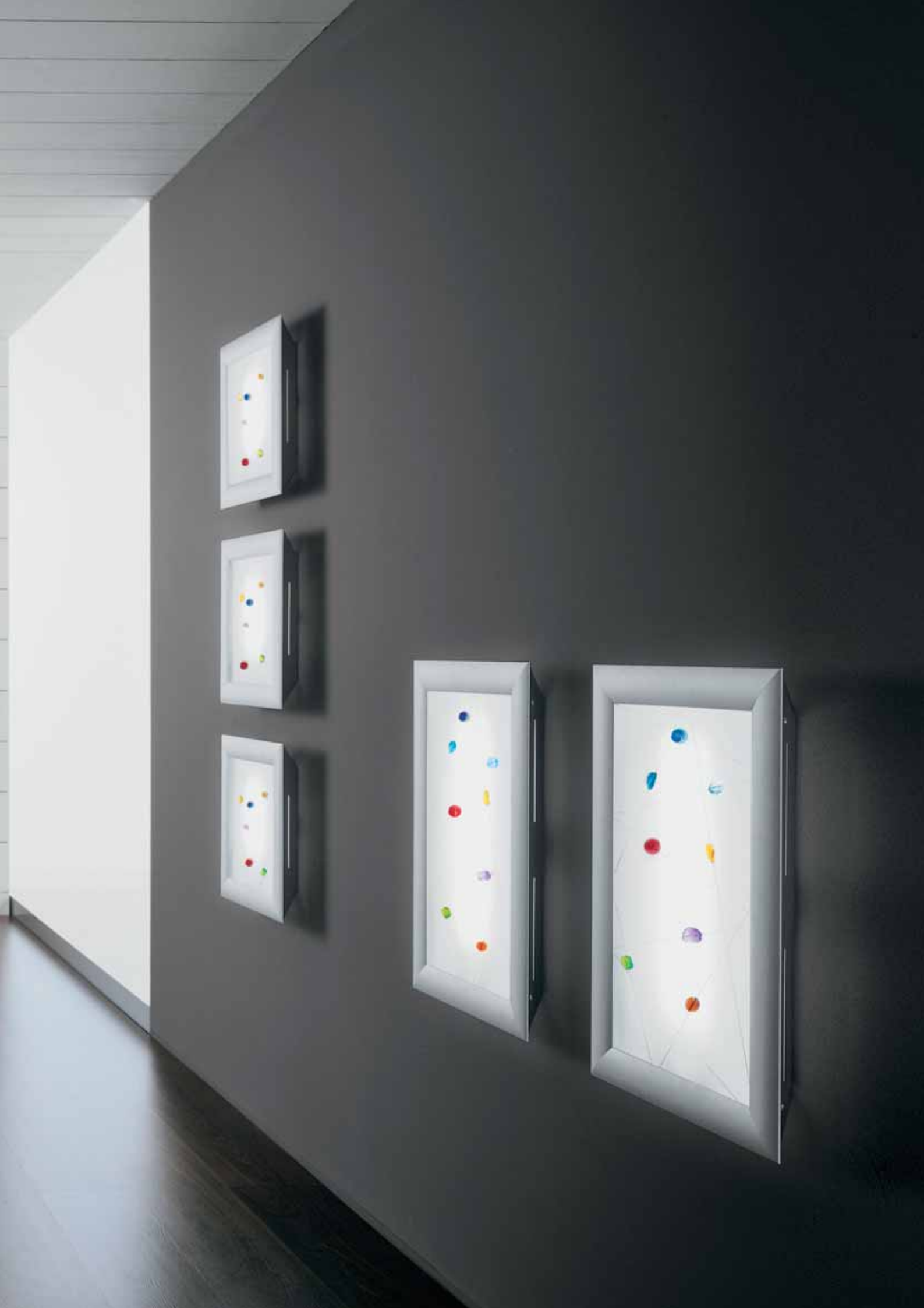





A SPARK OF LIGHT ILLUMINATES YOUR HOME OR OFFICE WITH DISCERNING STYLE AND PERSONALITY.

L'ETINCELLE DE LUMIERE ALLUME L'ESPACE DE LA MAISON ET DU BUREAU, AVEC CLASSE ET PERSONALITE.

LA CENTELLA DE LA LUZ ENCIENDE EL ESPACIO DE LA CASA Y DE LA OFICINA, CON CLASE Y PERSONALIDAD.







ALL STARS

ENZO PANZERI

CEILING AND WALL LAMP WITH
FRAME IN SANDED ALUMINIUM.
MATTE GLASS AND STAINLESS
INOX WIRE WITH COLORED
GLASS BALLS.
ELECTRONIC BALLAST.

LAMPE DE PLAFON ET APPLIQUE
AVEC CADRE EN ALUMINIUM
SABLÉ. VERRE SATINÉ ET FIL
ACIER INOXYDABLE AVEC DES
PERLES EN VERRE COLORÉ.
VERSION FLUORESCENT AVEC
REACTEUR ÉLECTRONIQUE.
LÂMPARA DE PARED Y DE

TECHO CON MARCO IN
ARENADO ALUMINIO. VIDRIO
SATINADO Y ALAMBRE ACERO
INOXIDABLE CON PERLAS DE
VIDRIO COLORADO VERSIÓN
FLUORESCENTE CON REACTOR
ELECTRÓNICO.

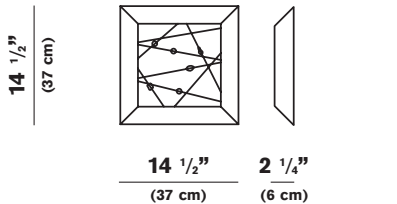
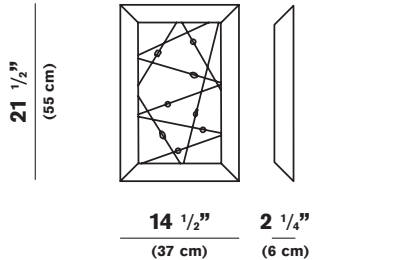
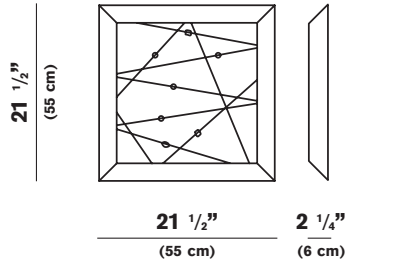
<p>D8-3080 FLUO WALL SCONCE MAX 2x18W 2G11</p>  <p>14 1/2" (37 cm)</p> <p>14 1/2" (37 cm) 2 1/4" (6 cm)</p> <p>ELECTRONIC BALLAST INCLUDED AVEC ALIMENTATEUR ÉLECTRONIQUE ALIMENDADOR ELECTRÓNICO INCLUIDO CAN BE MOUNTED AS A CEILING LIGHT UTILISABLE COMME PLAFONNIER UTILIZABLE COMO PLAFÓN</p>	<p>D8-3081 WALL SCONCE MAX 2x36W 2G11</p>  <p>21 1/2" (55 cm)</p> <p>14 1/2" (37 cm) 2 1/4" (6 cm)</p> <p>ELECTRONIC BALLAST INCLUDED AVEC ALIMENTATEUR ÉLECTRONIQUE ALIMENDADOR ELECTRÓNICO INCLUIDO CAN BE MOUNTED AS A CEILING LIGHT UTILISABLE COMME PLAFONNIER UTILIZABLE COMO PLAFÓN</p>	<p>D8-3082 WALL SCONCE MAX 4x36W 2G11</p>  <p>21 1/2" (55 cm)</p> <p>21 1/2" (55 cm) 2 1/4" (6 cm)</p> <p>ELECTRONIC BALLAST INCLUDED AVEC ALIMENTATEUR ÉLECTRONIQUE ALIMENDADOR ELECTRÓNICO INCLUIDO CAN BE MOUNTED AS A CEILING LIGHT UTILISABLE COMME PLAFONNIER UTILIZABLE COMO PLAFÓN</p>
---	---	--

ENZO PANZERI 2006

BOLLARD



NEW CLASSY AND DISTINCTIVE CREATIVE HORIZONS LIGHT UP YOUR HOME. BOLLARD GIVES YOU THE DELIGHT OF CONSTANT DISCOVERY A MOMENT AT A TIME. WHEN YOU TURN ON THIS CREATION OF LIGHT, YOU TURN ON STYLE.

DE NOUVEAUX HORIZONS CRÉATIFS ILLUMINENT LA MAISON, AVEC CLASSE ET PERSONNALITÉ. BOLLARD, C'EST LE PLAISIR D'UNE REDÉCOUVERTE PERPÉTUELLE, DE TOUS LES INSTANTS. UNE CRÉATION LUMINAIRE QUI, EN S'ÉCLAIRANT, CRÉE AUSSI UN STYLE.

NUEVOS HORIZONTES CREATIVOS ILUMINAN LA CASA, CON CLASE Y PERSONALIDAD. BOLLARD ES EL PLACER DE UN REDESCUBRIMIENTO CONTINUO, MOMENTO TRAS MOMENTO. UNA CREACIÓN DE LUZ QUE, AL ENCENDERSE, ENCIENDE EL ESTILO.









BOLLARD











BOLLARD

ENZO PANZERI

TABLE AND WALL LAMPS IN MATTE WHITE BLOWN GLASS. TABLE LAMPS FITTINGS IN TURNED PAINTED METAL WALL LAMP FITTINGS IN WHITE PAINT FINISH.

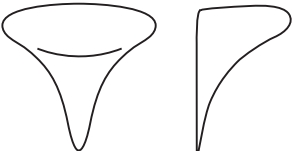
LAMPES DE TABLE ET APPLIQUES EN VERRE SOUFLÉ BLANC SATINÉ. MONTURE DE LA LAMPE DE TABLE EN MÉTAL TOURNÉ ET VERNI. MONTURE DES APPLIQUES VERNIE BLANC.

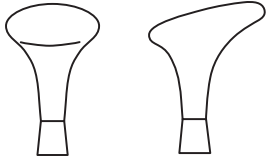
LÁMPARAS DE MESA Y DE PARED DE VIDRIO SOPLADO BLANCO SATINADO. MONTURA DE LA LÁMPARA DE MESA DE METAL TORNEADO Y BARNIZADO. MONTURA DE LAS LÁMPARAS DE PARED BARNIZADA BLANCA.

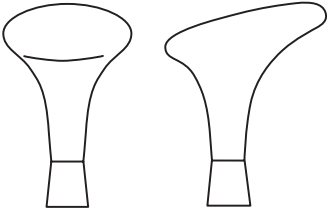
<p>D8-3087 WALL SCONCE MAX 100W T3Q/3 (79 mm)  ADA</p>  <p>7 ⁷/₈" (20 cm)</p> <p>3 ³/₈" (8,5 cm)</p>	<p>D8-3088 WALL SCONCE MAX 100W T3Q/3 (79 mm) </p>  <p>8 ¹/₄" (21 cm)</p> <p>5 ¹/₂" (14 cm)</p>	<p>D8-4090 TABLE LAMP MAX 60W E12 </p>  <p>13 ³/₈" (34 cm)</p> <p>8 ¹/₄" (21 cm)</p> <p>10 ¹/₄" (26 cm)</p>
<p>D8-4091 TABLE LAMP MAX 150W E26 </p>  <p>24 ³/₄" (63 cm)</p> <p>15 ³/₈" (39 cm)</p> <p>19 ¹/₄" (49 cm)</p>		

ENZO PANZERI 1998

TWISTER

THE PLEASURE OF LIVING AND OF IDENTIFYING ONESELF IN THE VARIOUS SHAPES AND FORMS OF THE HOUSE. WITH THE FEEL THAT EVERYTHING SPEAKS OF US, OUR TASTE AND WHO WE ARE.

LE PLAISIR D'HABITER, DE S'IDENTIFIER PLEINEMENT DANS LES FORMES DE LA MAISON. SENTIR QUE TOUT PARLE DE NOUS, DE NOTRE GOUT, DE NOTRE FAÇON D'ETRE.

EL PLACER DE HABITAR, DE RECONOCERSE PLENAMENTE EN LAS FORMAS DE LA CASA. SENTIR QUE TODO HABLA DE NOSOTROS, DE NUESTRO GUSTO, DE NUESTRA MANERA DE SER.





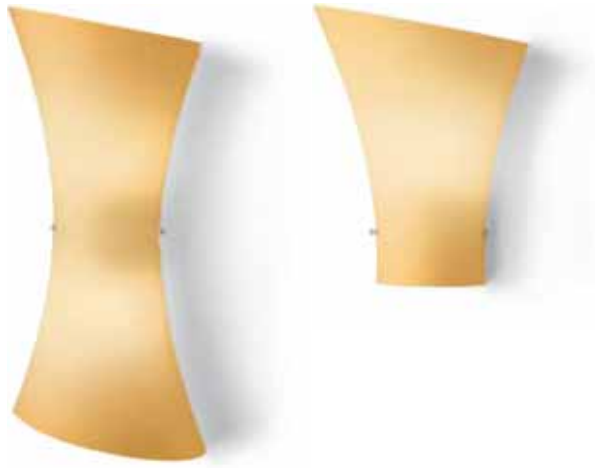

TWISTER

ELEGANT SINUOUS LINES THAT
DESCRIBE AN EMOTION THAT
CATCHES THE EYE.

DES LIGNES A LA SINUOSITE
ELEGANTES RACONTENT UNE
EMOTION QUI CAPTURE LE REGARD.

LÍNEAS DE ELEGANTE SINUOSIDAD
NARRAN UNA EMOCIÓN QUE CAPTURA
LA MIRADA.



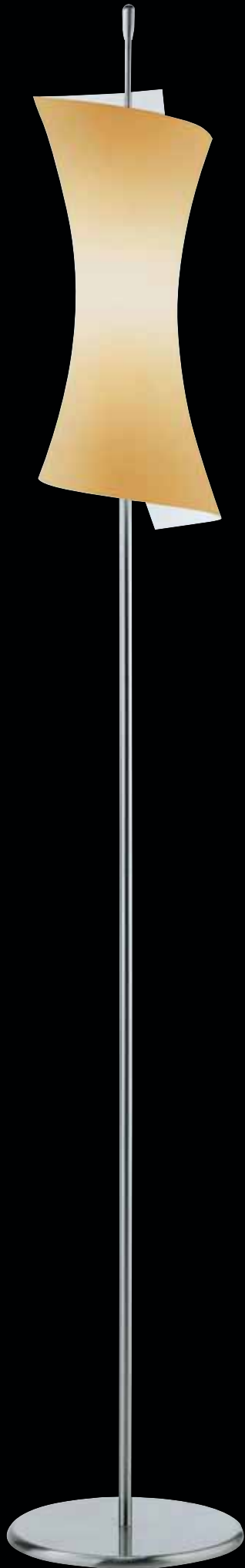

THE GLASS WRAPPED AROUND ITSELF,
ENCLOSES THE LIGHT AS IF IT WERE
SOMETHING PRECIOUS TO BE OFFERED.

LE VERRE S'ENROULE SUR LUI-MEME,
RENFERME LA LUMIERE COMME
QUELQUE CHOSE DE PRECIEUX A
OFFRIR.

EL VIDRIO SE ENVUELVE EN SÍ MISMO,
ENCIERRA LA LUZ COMO ALGO DE
PRECIOSO PARA OFRECER.



TWISTER

















TWISTER

ENZO PANZERI

TABLE, FLOOR, PENDANT
AND WALL LAMPS IN MATTE
NICKEL METAL.
BLOWN WHITE OR AMBER
MATTE GLASS.

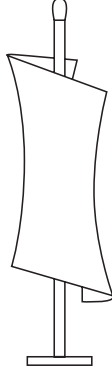
LAMPE AU SOL, LAMPE
DE TABLE, DE PLAFOND ET
APPLIQUE EN NICKEL SATINE.
VERRE SOUFFLE BLANC OU
AMBRE SATINE.

LÁMPARA DE SUELO,
DE MESA, DE TECHO Y DE
PARED DE NIQUEL SATINADO.
VIDRIO SOPLADO BLANCO
O ÁMBAR SATINADO.

<p>D8-1042 AMBER</p>  <p>13 1/4" (34 cm)</p> <p>5 1/2" (14 cm)</p>	<p>D8-1043 AMBER</p>  <p>21 1/2" (55 cm)</p> <p>8" (20 cm)</p>	<p>D8-1000 WHITE PENDANT MAX 60W CAND. or 50W XENON</p>  <p>D8-1001 WHITE PENDANT MAX 150W T10</p>  <p>D8-3063 AMBER</p>  <p>12 1/2" (32 cm)</p> <p>9 1/2" (24 cm)</p> <p>D8-3000 WHITE WALL SCONCE MAX 100W MED.</p>  <p>4 1/4" (11 cm)</p> <p>AVAILABLE IN COMPACT FLUORESCENT</p>
<p>D8-3064 AMBER</p>  <p>20" (51 cm)</p> <p>9 1/2" (24 cm)</p> <p>D8-3001 WHITE WALL SCONCE MAX 2x100W MED.</p>  <p>4 1/4" (11 cm)</p> <p>AVAILABLE IN COMPACT FLUORESCENT</p>	<p>D8-4072 AMBER</p>  <p>20" (51 cm)</p> <p>6" (15 cm)</p> <p>D8-4000 WHITE TABLE LAMP MAX 60W CAND. or 50W XENON</p> 	<p>D8-4073 AMBER</p>  <p>30 3/4" (78 cm)</p> <p>8 1/4" (21 cm)</p> <p>D8-4001 WHITE TABLE LAMP MAX 150W T10</p> 
<p>D8-4074 AMBER</p>  <p>72" (183 cm)</p> <p>11 1/2" (29 cm)</p> <p>D8-4002 WHITE FLOOR LAMP MAX 250W T10</p> 		

TEAM DESIGN 2001

KUBIK

THE SENSE OF PROPORTION
DOMINATES AND INSPIRES THE
DESIGN OF THE COMPOSITION:
A PURE ESSENTIAL THAT
PROVES TO BE RICH IN
ACCENTS AND NUANCES.

LE SENS DE LA MESURE
DOMINE ET INSPIRE LE DESIGN
DE LA COMPOSITION: UN
ESSENTIALISME PUR QUI,
POURTANT, SE REVELE RICHE
D'ACCENTS ET DE NUANCES.

DOMINA EL SENTIDO DE LA
MEDIDA E INSPIRA EL DESIGN
DE LA COMPOSICIÓN: UNA
PURA ESENCIALIDAD QUE SE
DEMUESTRA RICA DE
TONALIDADES Y ESFUMATURAS.









KUBIK

LIGHTING SOLUTIONS THAT BECOME
THE MAIN PROTAGONIST IN THE HOME.

DES OBJETS QUI SAVENT SE RENDRE
PROTAGONISTES DE L'ESPACE MAISON.

OBJETOS QUE SABEN TRANSFORMARSE
EN PROTAGONISTAS DEL ESPACIO CASA.

KUBIK

THE PLEASURE OF A NEW BEAUTY CAN
BE FOUND IN THE CONTRASTS BETWEEN
THE LAMP AND STAND.

DANS LE RAPPORT DE PROPORTIONS
ENTRE LAMPE ET SUPPORT, LE PLAISIR
D'UNE NOUVELLE BEAUTE.

EN LA RELACIÓN DE PROPORCIONES
ENTRE LÁMPARA Y SOPORTE, EL PLACER
DE UNA NUEVA BELLEZA.

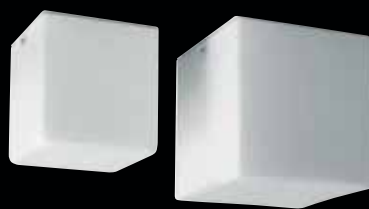



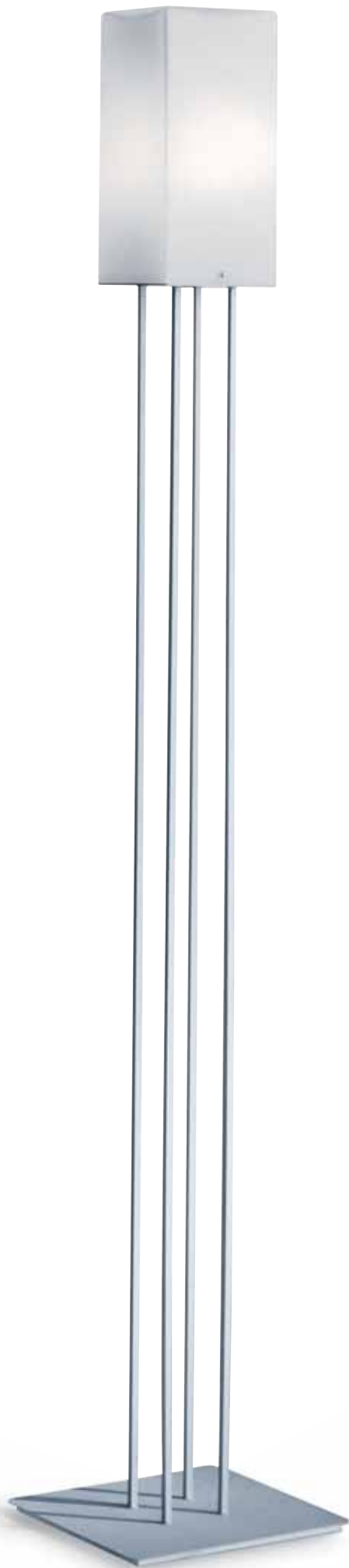









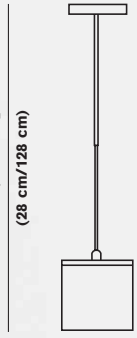

KUBIK

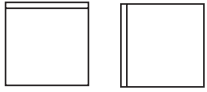
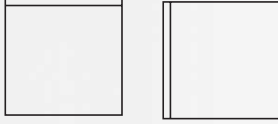
TEAM DESIGN

PENDANT, CEILING,
FLOOR, TABLE AND WALL
LAMP IN METALLIZED GRAY
METAL. BLOWN WHITE MATTE
GLASS.

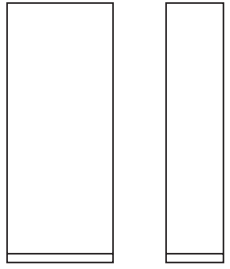
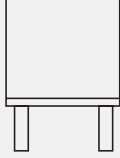
SUSPENSION, PLAFONNIER,
LAMPE AU SOL, LAMPE DE TABLE
ET APPLIQUE EN GRIS
METALLISE. VERRE SOUFFLE
BLANC SATINE.

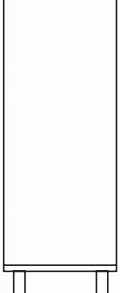
SUSPENSIÓN, PLAFÓN,
LÁMPARA DE SUELO, DE MESA Y
DE PARED GRIS METALIZADO.
VIDRIO SOPLADO BLANCO
SATINADO.

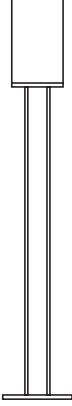
<p>D8-1002 PENDANT MAX 60W G9</p>  <p>26 3/4 / 50 1/2" (28 cm / 128 cm)</p> <p>4 1/4" (11 cm)</p>	<p>D8-1003 PENDANT MAX 75W G9</p>  <p>27 1/2 / 51 1/4" (70 cm / 130 cm)</p> <p>5 1/2" (14 cm)</p>	<p>D8-3002 WALL SCONCE MAX 60W G9</p>  <p>4 1/2" (11 cm)</p> <p>4 1/2" (11 cm)</p>
<p>D8-3003 WALL SCONCE MAX 75W G9</p>  <p>5 1/2" (14 cm)</p> <p>5 1/2" (14 cm)</p>	<p>D8-3004 WALL SCONCE MAX 100W T3Q (119 mm)  ADA</p>  <p>4 1/4" (11 cm)</p> <p>9 3/4" (25 cm)</p> <p>2 1/4" (6 cm)</p> <p>AVAILABLE IN COMPACT FLUORESCENT</p>	<p>D8-3005 WALL SCONCE MAX 100W T10 ADA </p>  <p>11 1/2" (29 cm)</p> <p>5 1/2" (14 cm)</p> <p>2 3/4" (7 cm)</p> <p>AVAILABLE IN COMPACT FLUORESCENT</p>
<p>D8-4003 TABLE LAMP MAX 60W G9</p>  <p>6 1/4" (16 cm)</p> <p>4 1/4" (11 cm)</p>	<p>D8-4004 TABLE LAMP MAX 150W T10 </p>  <p>13 3/4" (35 cm)</p> <p>5 1/2" (14 cm)</p>	<p>D8-4005 FLOOR LAMP MAX 250W T10 </p>  <p>63 3/4" (162 cm)</p> <p>10 1/2" (27 cm)</p>

ENZO PANZERI
MARIO ORNAGHI 2003

BLOW

BRILLIANT ALTERNATIVES THAT
ALLOW THE LIGHT TO EXPRESS
ITSELF TO ITS BEST, ENHANCING
THE VALUE OF THE AMBIENCE
ENRICHING IT WITH A
SUGGESTIVE APPEARANCE.

DE BRILLANTES SOLUTIONS
PERMETTENT A LA LUMIERE DE
S'EXPRIMER DE SON MIEUX,
EN VALORISANT L'AMBIANCE
ET EN L'ENRICHISSANT D'UNE
PRESENCE SUGGESTIVE.

BRILLANTES SOLUCIONES
PERMITEN A LA LUZ
EXPRESARSE DE LA MEJOR
MANERA, VALORIZANDO
EL AMBIENTE Y
ENRIQUECIÉNDOLO DE
UNA SUGESTIVA PRESENCIA.







BLOW

EXPLORING THE WORLD OF SHAPES
YOU WILL DISCOVER LIVELY AND
BRILLIANT AESTHETIC VALUES.

EN EXPLORANT LE MONDE DES
FORMES ON ARRIVE A DECOUVRIR DES
VALEURS ESTHETIQUES PLUS VIVES ET
PLUS BRILLANTES.

EXPLORANDO EL MUNDO DE LAS
FORMAS SE LLEGAN A DESCUBRIR
VALORES ESTÉTICOS MÁS VIVOS Y
BRILLANTES.



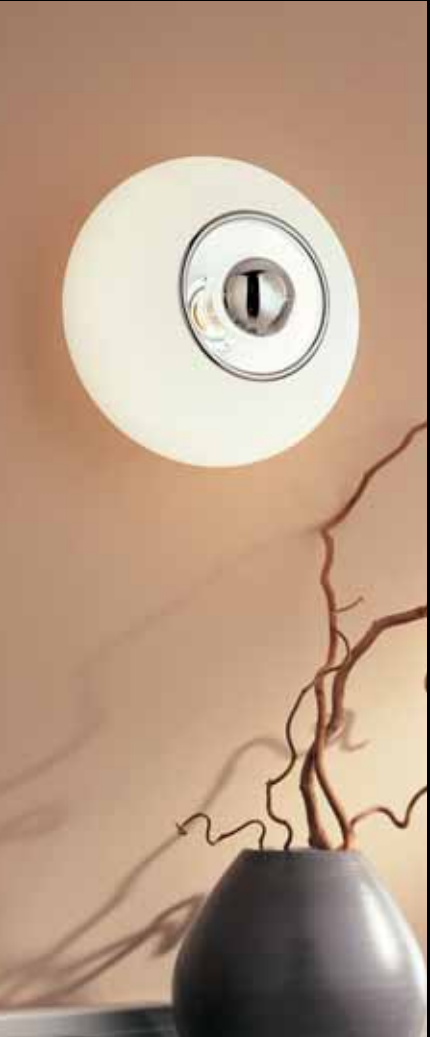
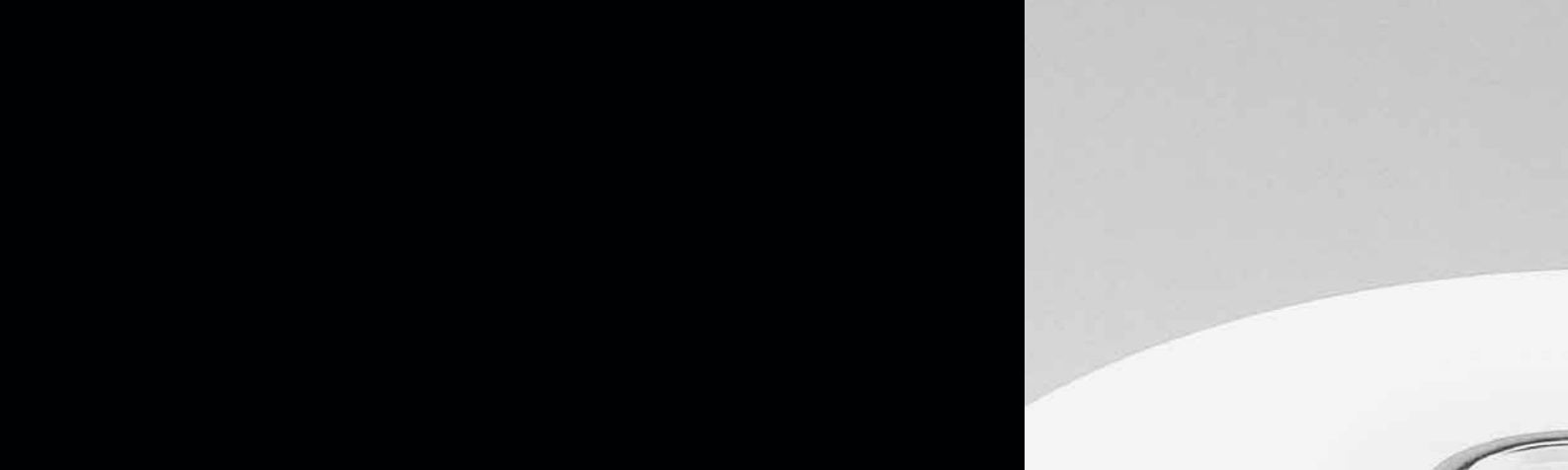

BLOW

ENZO PANZERI
MARIO ORNAGHI

TABLE, FLOOR, CEILING
AND WALL LAMPS AND
PENDANTS IN MATTE
NICKEL METAL. BLOWN
WHITE MATTE GLASS.

LAMPE AU SOL, LAMPE DE
TABLE, APPLIQUE, PLAFONNIERS
ET SUSPENSION EN NICKEL.
VERRE SOUFFLE BLANC SATINE.

LÁMPARA DE SUELO, DE MESA,
DE PARED, PLAFONES Y
SUSPENSIONES NIQUEL. VIDRIO
SOPLADO BLANCO SATINADO.

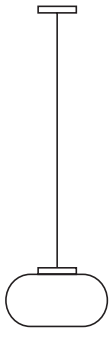
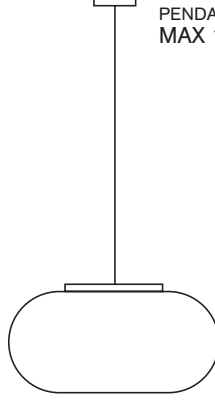
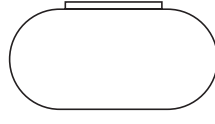
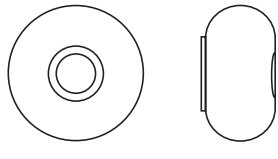
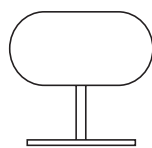
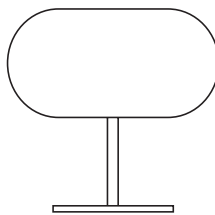
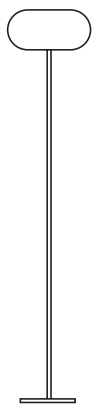
<p>D8-1004 PENDANT MAX 60W CAND. or 50W XENON</p>  <p>5" (13 cm) 9" (23 cm)</p>	<p>D8-1005 PENDANT MAX 150W T10</p>  <p>7" (18 cm) Ø 15 3/4" (Ø 39 cm)</p>	<p>D8-2000 FLUSH MOUNT MAX 2X75W MED.</p>  <p>7" (18 cm) Ø 15 1/4" (Ø 39 cm)</p>
<p>D8-3006 WALL SCONCE E26 HALF MIRROR</p>  <p>9" (23 cm) Ø 9" (Ø 23 cm) 6" (15 cm)</p>	<p>D8-4006 TABLE LAMP MAX 60W CAND. or 50W XENON</p>  <p>9" (23 cm) Ø 9" (Ø 23 cm)</p>	<p>D8-4007 TABLE LAMP MAX 150W T10</p>  <p>13" (33 cm) Ø 15 1/4" (Ø 39 cm)</p>
<p>D8-4008 FLOOR LAMP MAX 250W T10</p>  <p>72 3/4" (185 cm) Ø 15 1/4" (Ø 39 cm)</p>		

ENZO PANZERI 2003

BLOW MINI

FROM LARGE TO SMALL,
A CHANGE OF PERSPECTIVE
THAT MAKES THE LIGHT
OFFER ITSELF IN A DIFFERENT
WAY: ALWAYS A MARK
OF UNMISTAKEABLE STYLE.

DU GRAND AU PETIT, UN
CHANGEMENT DE PROSPECTIVE
QUI CONDUIT LA LUMIERE
A S'OFFRIR DE FAÇON
DIFFERENTE: TOUJOURS
A L'ENSEIGNE D'UN STYLE
UNIQUE.

DEL GRANDE AL PEQUEÑO, UN
CAMBIO DE PERSPECTIVA QUE
LLEVA LA LUZ A OFRECERSE DE
MANERA DIVERSA: SIEMPRE A
LA INSIGNIA DE UN ESTILO
INCONFUNDIBLE.







BLOW MINI

AN ENSEMBLE OF LIGHT SOURCES
THAT EMPHASIZE AND RECREATE THE
AMBIENCE ENHANCING ITS FEATURES
TO THE BEST.

UN ENSEMBLE DE SOURCES DE
LUMIERE QUI SOULIGNE L'AMBIANCE
ET LA RECREE, EN VALORISANT AU
MIEUX SES CARACTERISTIQUES.

UN CONJUNTO DE FUENTES DE LUCES
QUE RESALTA EL AMBIENTE Y LO
RECREA, VALORIZANDO AL MÁXIMO
LAS CARACTERÍSTICAS.













BLOW MINI

ENZO PANZERI

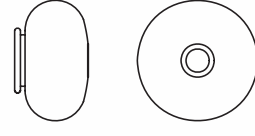
FLOOR, TABLE, WALL,
CEILING AND PENDANTS
FIXTURES IN MATTE NICKEL
METAL. BLOWN WHITE
MATTE GLASS.

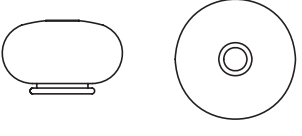
LAMPE AU SOL, LAMPE DE
TABLE, APPLIQUE, LAMPE DE
PLAFOND ET SUSPENSION, EN
NICKEL SATINE.
VERRE SOUFFLE BLANC.

LÁMPARA DE SUELO, DE MESA,
DE PARED, DE
TECHO Y DE SUSPENSIÓN, DE
NIQUEL SATINADO.
VIDRIO SOPLADO BLANCO.

 <p>D8-1006 PENDANT MAX 60W G9 </p> <p>$3 \frac{1}{2}''$ (9 cm)</p> <p>$\varnothing 5 \frac{1}{2}''$ ($\varnothing 14$ cm)</p>	 <p>D8-3008 WALL SCONCE MAX 60W G9 ADA </p> <p>$5 \frac{1}{2}''$ (14 cm)</p> <p>$\varnothing 3 \frac{1}{2}''$ ($\varnothing 9$ cm)</p>	 <p>D8-4009 TABLE LAMP MAX 60W G9 </p> <p>$3 \frac{1}{2}''$ (9 cm)</p> <p>$\varnothing 5 \frac{1}{2}''$ ($\varnothing 14$ cm)</p>
 <p>D8-4010 FLOOR LAMP MAX 75W G9 </p> <p>$67''$ (170 cm)</p> <p>$\varnothing 8 \frac{1}{2}''$ ($\varnothing 22$ cm)</p>		

ENZO PANZERI 2003

ALVI

PLEASANTLY SURPRISING
SINUOUS LINES ASSERT
THEMSELVES IN THE LIVING-
SPACE OFFERING NEW
FURNISHING IDEAS WITH
A FASCINATING AND LIMPID
PERSONALITY.

DES LIGNES SINUEUSES,
AGREABLEMENT INATTENDUES,
S'IMPOSENT DANS L'ESPACE
EN LUI OFFRANT DE
NOUVELLES INSPIRATIONS
A LA PERSONNALITE
FASCINANTE ET LIMPIDE.

LÍNEAS SINUOSAS,
PLÁCIDAMENTE
INESPERADAS, SE IMPONEN
EN EL ESPACIO
OFRECIÉNDOLE NUEVAS
OCASIONES DE FASCINANTE,
LÍMPIDA PERSONALIDAD.

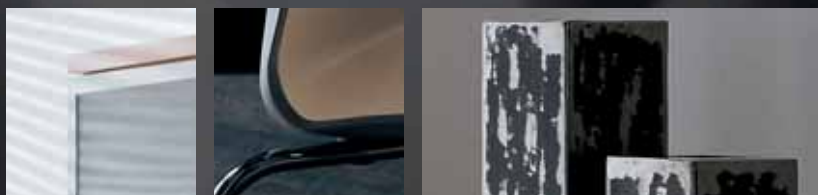





ALVI

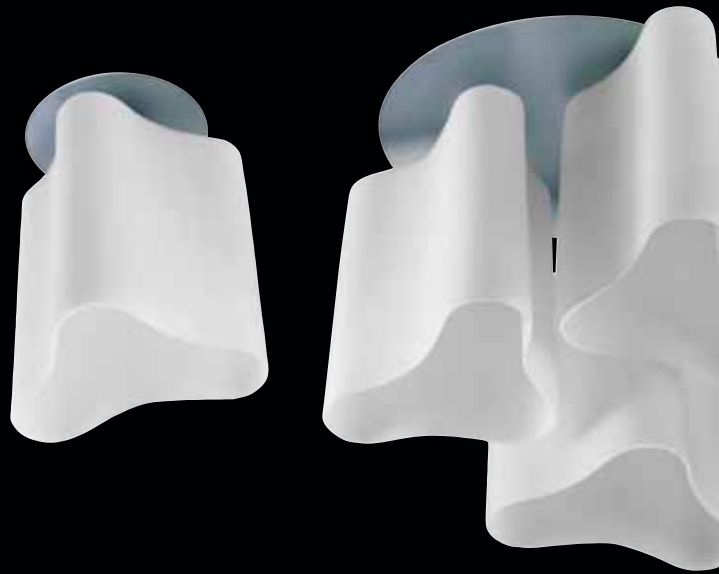

MOULDED SHAPES TO REACH A NEW
DIMENSION OF BEAUTY.

MODELER LES FORMES, POUR
REJOINDRE UNE NOUVELLE DIMENSION
DE LA BEAUTE.

ADAPTAR LAS FORMAS, PARA LLEGAR A
UNA NUEVA DIMENSIÓN DE LA BELLEZA.







DESIGN FURNISHINGS THAT EMPHASIZE
THE PLEASURE OF LIVING.

OBJETS DE DESIGN QUI SOULIGNENT LE
PLAISIR D'HABITER.



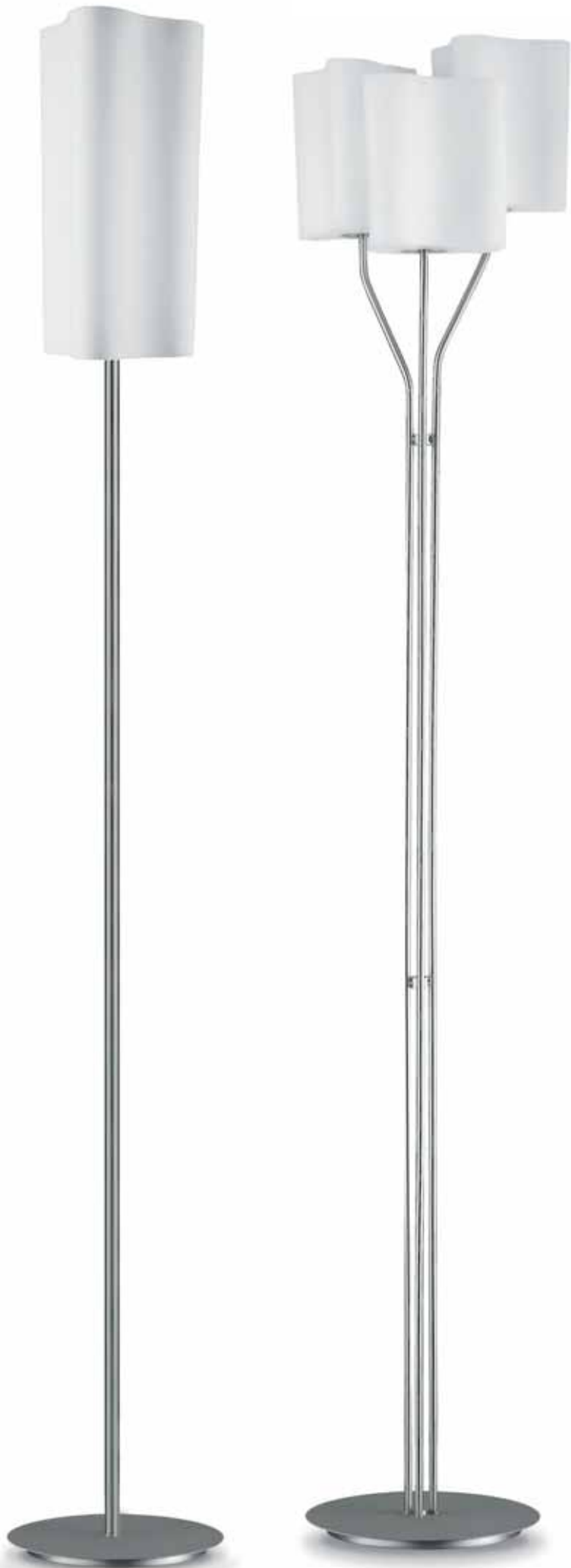

OBJETOS DE DISEÑO QUE RESALTAN EL
PLACER DE HABITAR.

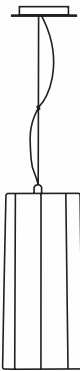
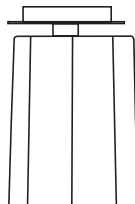
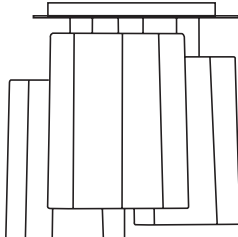
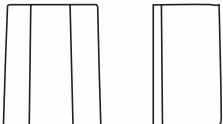
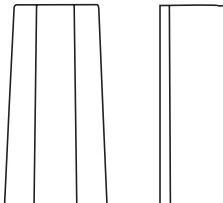

FLOOR, TABLE, WALL,
CEILING LAMPS AND
PENDANTS IN METALLIZED
GRAY METAL. BLOWN WHITE
MATTE GLASS.

LAMPE AU SOL, LAMPE
DE TABLE, APPLIQUE,
PLAFONNIERS ET
SUSPENSION EN GRIS
METALLISE. VERRE
SOUFFLE BLANC SATINE.

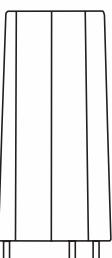
LÁMPARA DE SUELO,
DE MESA, DE PARED,
PLAFONES Y SUSPENSIONES GRIS
METALIZADO. VIDRIO
SOPLADO BLANCO SATINADO.

<p>D8-1007 PENDANT MAX 150W T10</p>  <p>14 1/4" (36 cm)</p> <p>6 3/4" (17 cm)</p>	<p>D8-2001 FLUSH MOUNT MAX 150W T10</p>  <p>9 1/2" (24 cm)</p> <p>6 3/4" (17 cm)</p>	<p>D8-2002 FLUSH MOUNT MAX 3x100W T10</p>  <p>11 3/4" (30 cm)</p> <p>12 1/4" (31 cm)</p>
<p>D8-3009 WALL SCONCE MAX 100W T10 ADA</p>  <p>7 3/4" (20 cm)</p> <p>6 3/4" (17 cm)</p> <p>3 1/4" (8 cm)</p> <p>AVAILABLE IN COMPACT FLUORESCENT</p>	<p>D8-3010 WALL SCONCE MAX 150W T10 ADA</p>  <p>14 1/4" (36 cm)</p> <p>6 3/4" (17 cm)</p> <p>3 1/4" (8 cm)</p> <p>AVAILABLE IN COMPACT FLUORESCENT</p>	<p>D8-4011 TABLE LAMP MAX 75W MED.</p>  <p>9" (23 cm)</p> <p>6 3/4" (17 cm)</p>
<p>D8-4012 TABLE LAMP MAX 75W MED.</p>  <p>15 1/4" (39 cm)</p> <p>6 3/4" (17 cm)</p>	<p>D8-4013 FLOOR LAMP MAX 250W T10</p>  <p>72 3/4" (185 cm)</p> <p>10 1/2" (27 cm)</p>	<p>D8-4014 FLOOR LAMP MAX 3x100W T10</p>  <p>71" (180 cm)</p> <p>13" (33 cm)</p>

FRIEDRICH REIFFER 1995

DELPHINA

MODULARITY AND RATIONALITY
OPEN NEW HORIZONS FOR THE
MODERN HOME. FROM THIS
PERSPECTIVE, LIGHT BECOMES
A SIGN OF THE TIMES.

MODULARITE ET RATIONALITE
OUVRENT DE NOUVEAUX
HORIZONS DE STYLE POUR LA
MAISON CONTEMPORAINE.
DANS CETTE PROSPECTIVE, LA
LUMIERE DEVIENT UN SIGNE
DES TEMPS.

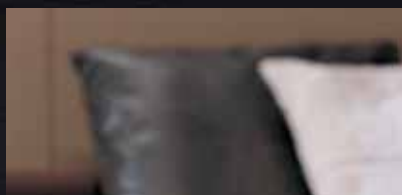
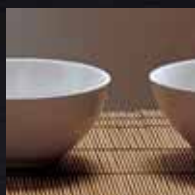

MODULARIDAD Y RACIONALIDAD
ABREN NUEVOS HORIZONTES
DE ESTILO PARA LA CASA
CONTEMPORÁNEA. EN ESTA
PERSPECTIVA, LA LUZ SE
VUELVE UNA SEÑAL DEL
TIEMPO.

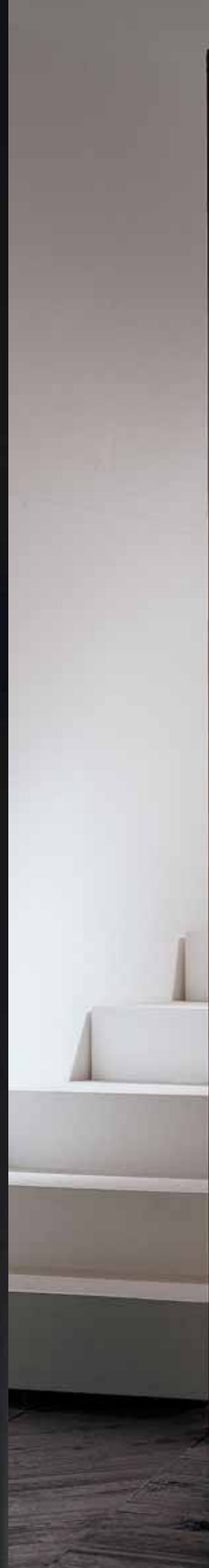







DELPHINA

WITH METICULOUS CARE AND ATTENTION TO DETAIL, THE LIVING-SPACE IS CHARACTERIZED BY WHO LIVES IN IT. A CONTEXT TO SEE AND TO LIVE IN AN EVER CHANGING LIGHT.

DANS LE SOIN DE CHAQUE DETAIL, L'ESPACE ENVIRONNANT DEVIENT TEMOIN DU GOUT DE CEUX QUI L'HABITE: UN CONTEXTE A VOIR ET A VIVRE SOUS UNE LUMIERE TOUJOURS DIFFERENTE.

CON EL CUIDADO DE CADA DETALLE, EL ESPACIO AMBIENTE SE CONVIERTE EN LA TESTIMONIANZA DEL GUSTO DE QUIEN LO HABITA: UN ENTORNO PARA VER Y PARA VIVIR BAJO UNA LUZ SIEMPRE DISTINTA.









DELPHINA

FRIEDRICH REIFFER

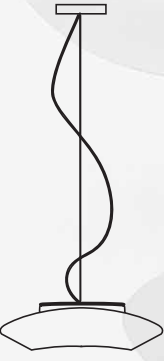
CEILING AND PENDANT
FIXTURES IN WHITE METAL.
BLOWN WHITE MATTE GLASS.

LAMPE DE PLAFOND ET SUSPEN-
SION EN METAL BLANC ET
VERRE SOUFFLE BLANC SATINE.

LÁMPARAS DE TECHO Y DE
SUSPENSIÓN DE METAL BLANCO
Y VIDRIO SOPLADO BLANCO
SATINADO.

<p>D8-1008 PENDANT MAX 60W G9 </p>  <p>$4 \frac{1}{4}''$ (11 cm)</p> <p>$\text{Ø } 7 \frac{3}{4}''$ (Ø 20 cm)</p>	<p>D8-2003 FLUSH MOUNT MAX 60W G9 </p>  <p>$4 \frac{1}{4}''$ (11 cm)</p> <p>$\text{Ø } 7 \frac{3}{4}''$ (Ø 20 cm)</p>	<p>D8-2004 FLUSH MOUNT MAX 150W T3Q/3 (79 mm) </p>  <p>$6 \frac{1}{4}''$ (16 cm)</p> <p>$\text{Ø } 11 \frac{3}{4}''$ (Ø 30 cm)</p>
<p>D8-2005 FLUSH MOUNT MAX 150W T3Q/3 (79 mm) </p>  <p>$6 \frac{1}{4}''$ (16 cm)</p> <p>$\text{Ø } 17''$ (Ø 43 cm)</p>		

FRIEDRICH REIFFER 1996

DENIS

THE FLOW OF A WAVE CROSSES
AND MOVES THE SHAPE GIVING
IT A VERVE THAT FITS INTO THE
AMBIENCE WITH INTENSE AND
PLEASANT EVIDENCE.

LE FLUX D'UNE VAGUE
TRAVERSE ET DEPLACE LA
FORME, EN LUI DONNANT UNE
VERVE QUI SAIT S'INSERER
DANS L'AMBIANCE AVEC UNE
EVIDENCE INTENSE ET
AGREABLE.

EL FLUJO DE UNA OLA
ATRAVIESA Y MUEVE LA FORMA,
DÁNDOLE UNA VIVEZA QUE
SABE INTRODUCIR EN EL
AMBIENTE CON ACUERDO,
AGRADABLE EVIDENCIA.







DENIS

BRILLIANT SOLUTIONS, VIVACIOUS
PRESENCE. A TOUCH OF INTELLIGENCE
AND IRONY FOR A DISCERNING HOME.

SOLUTIONS BRILLANTES, PRESENCES
VIVACES. UNE TOUCHE D'INTELLIGENCE
ET D'IRONIE POUR LA MAISON
RAFFINEE.

BRILLANTES SOLUCIONES, PRESENCIAS
VIVACES. UN TOQUE DE INTELIGENCIA E
IRONIA PARA LA CASA REFINADA.

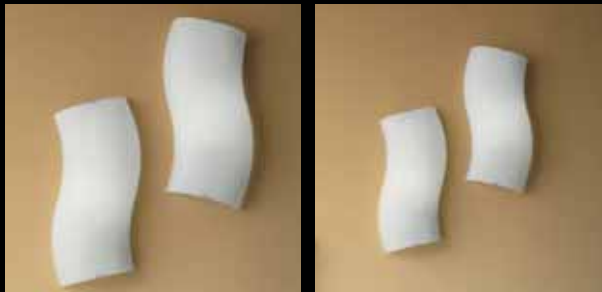

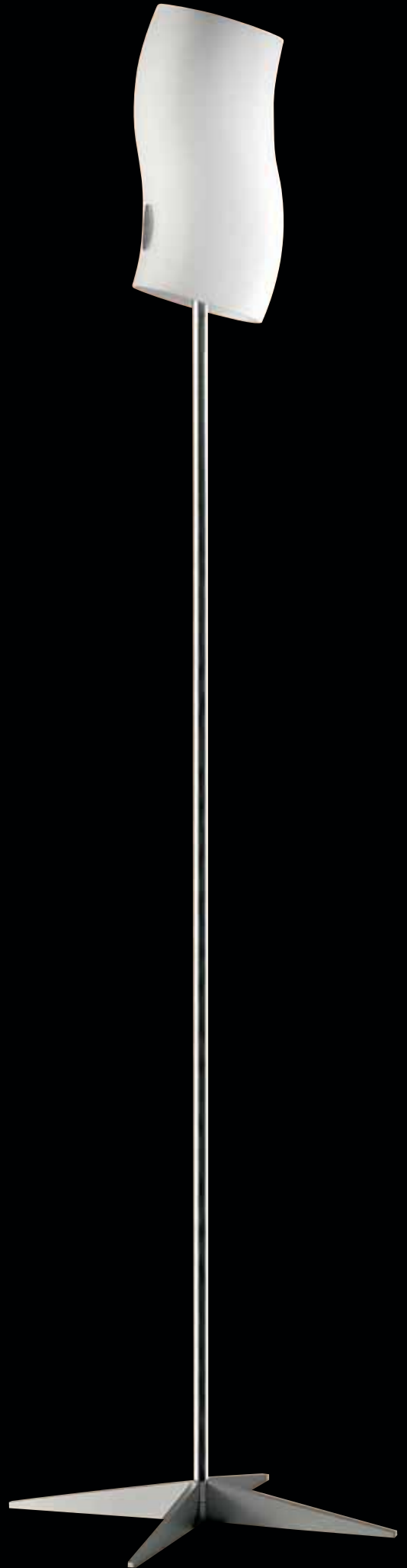

DENIS

FRIEDRICH REIFFER

PENDANT, FLOOR, AND TABLE LAMPS IN METALLIZED GREY METAL. BLOWN WHITE MATTE GLASS WALL LAMP. RIGHT SIDE (DX) AND LEFT SIDE (SX).

SUSPENSION, LAMPE AU SOL ET DE TABLE AU SOL ET DE TABLE EN GRIS METALLISE. VERRE SOUFFLE BLANC SATINE. APPLIQUE EN VERRE SOUFFLE BLANC SATINE. VERSION DROITE (DX). VERSION GAUCHE (SX).

SUSPENSIONES, LÁMPARAS DE SUELO Y DE MESA GRIS METALIZADO. VIDRIO SOPLADO BLANCO SATINADO. LÁMPARA DE PARED DE VIDRIO SOPLADO BLANCO SATINADO. VERSIÓN DERECHA BLANCO SATINADO. VERSIÓN IZQUIERDA.

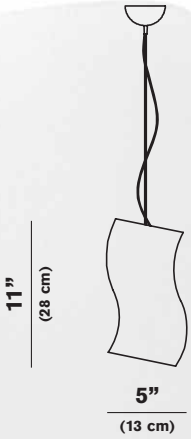
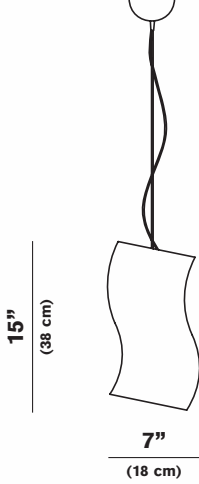
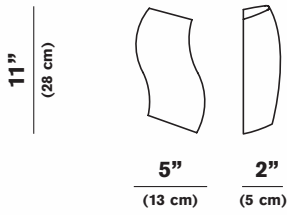
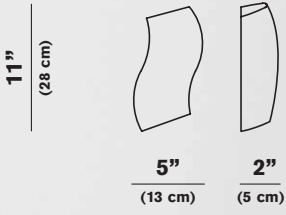
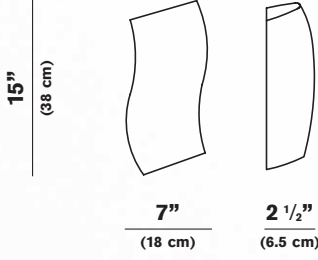
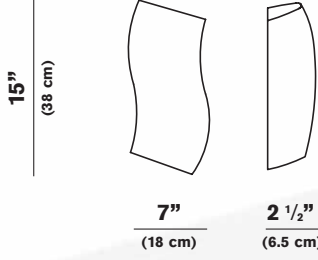
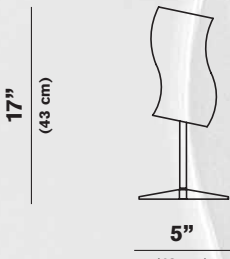
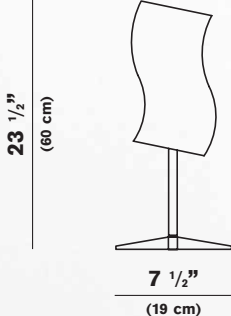
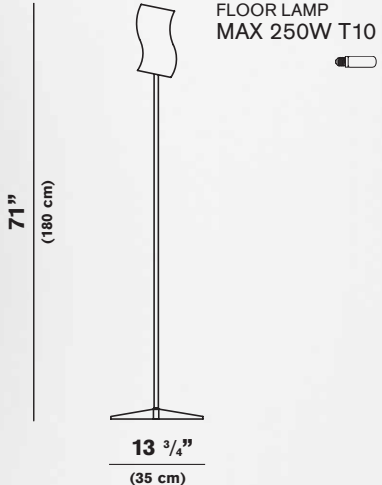
<p>D8-1009 PENDANT MAX 60W CAND. or 50W XENON</p>  <p>11" (28 cm)</p> <p>5" (13 cm)</p>	<p>D8-1010 PENDANT MAX 150W T10</p>  <p>15" (38 cm)</p> <p>7" (18 cm)</p>	<p>D8-3011 WALL SCONCE (LEFT) MAX 60W CAND. or 50W XENON ADA</p>  <p>11" (28 cm)</p> <p>5" (13 cm)</p> <p>2" (5 cm)</p>
<p>D8-3012 WALL SCONCE (RIGHT) MAX 60W CAND. or 50W XENON ADA</p>  <p>11" (28 cm)</p> <p>5" (13 cm)</p> <p>2" (5 cm)</p>	<p>D8-3013 WALL SCONCE (LEFT) MAX 150W T10 ADA</p>  <p>15" (38 cm)</p> <p>7" (18 cm)</p> <p>2 1/2" (6.5 cm)</p> <p>AVAILABLE IN COMPACT FLUORESCENT</p>	<p>D8-3014 WALL SCONCE (RIGHT) MAX 150W T10 ADA</p>  <p>15" (38 cm)</p> <p>7" (18 cm)</p> <p>2 1/2" (6.5 cm)</p> <p>AVAILABLE IN COMPACT FLUORESCENT</p>
<p>D8-4015 TABLE LAMP MAX 75W MED.</p>  <p>17" (43 cm)</p> <p>5" (13 cm)</p>	<p>D8-4016 TABLE LAMP MAX 150W T10</p>  <p>23 1/2" (60 cm)</p> <p>7 1/2" (19 cm)</p>	<p>D8-4017 FLOOR LAMP MAX 250W T10</p>  <p>71" (180 cm)</p> <p>13 3/4" (35 cm)</p>









DISCO

TEAM DESIGN 1998

WALL AND CEILING LAMP
MADE OF MATTE BLOWN
GLASS. HIDDEN WHITE
METAL FITTERS.

APPLIQUE ET PLAFONNIER
EN VERRE SOUFFLE SATINE
BLANC. STRUCTURE
CACHEE EN METAL VERNI
BLANC.

LÁMPARA DE PARED Y
PLAFÓN DE VIDRIO
SOPLADO SATINADO
BLANCO. ESTRUCTURA
ESCONDIDA DE METAL
BARNIZADO BLANCO.

<p>D8-2006 FLUSH MOUNT MAX 60W MED.</p>  <p>$3 \frac{1}{2}''$ (9 cm)</p>  <p>$11 \frac{3}{4}''$ (30 cm)</p>	<p>D8-2007 FLUSH MOUNT MAX 2x60W MED.</p>  <p>$4''$ (10 cm)</p>  <p>$15 \frac{3}{4}''$ (40 cm)</p>	<p>D8-2008 FLUSH MOUNT MAX 2x100W MED.</p>  <p>$6 \frac{1}{4}''$ (16 cm)</p>  <p>$19 \frac{3}{4}''$ (50 cm)</p>
--	---	--



FRIEDRICH REIFFER 1995

TECLA

SINGLE LAMPS OR LAMPS IN A MODULAR COMPOSITION, MAKE ANY AMBIENCE VIBRATE ENHANCING ITS FEATURES. ALWAYS IN AN IDEAL LIGHT.

LAMPE SIMPLE OU EN SEQUENCE MODULAIRE, POUR FAIRE VIBRER CHAQUE AMBIANCE SELON SES PROPRES CARACTERISTIQUES. DONC, DANS UNE LUMIERE TOUJOURS IDEALE.

LÁMPARAS INDIVIDUALES O EN SECUENCIA MODULAR, PARA HACER VIBRAR CADA AMBIENTE SEGÚN LAS PROPIAS CARACTERÍSTICAS. ES DECIR, EN UNA LUZ SIEMPRE IDEAL.

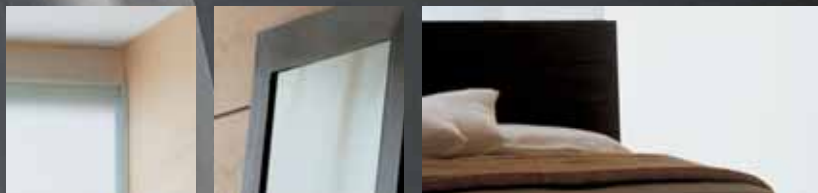





TECLA

METICULOUS CARE TO EVERY ELEMENT
BECAUSE REAL ELEGANCE IS CREATED
BY DETAILS.

SOIN MAXIMAL DE CHAQUE ELEMENT,
PARCE QUE L'ELEGANCE REELLE EST
FAITE DE DETAILS.

MÁXIMO CUIDADO EN CADA ELEMENTO,
YA QUE LA VERDADERA ELEGANCIA
ESTÁ REALIZADA POR DETALLES.









TECLA

THE QUALITY OF THE MATERIALS
CONFIRM YET AGAIN THE CARE WITH
WHICH THESE LIGHTING FIXTURES ARE
MANUFACTURED.

LA QUALITE DES MATERIAUX CONFIRME
ENCORE UNE FOIS L'ATTENTION AVEC
LAQUELLE CES OBJETS SONT REALISES.

LA CALIDAD DE LOS MATERIALES
CONFIRMA NUEVAMENTE LA ATENCIÓN
CON LA CUAL ESTOS OBJETOS SE
REALIZAN.











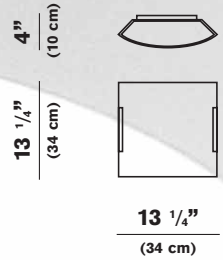

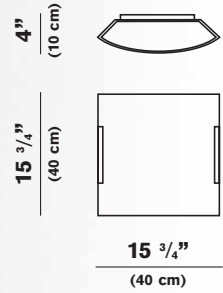

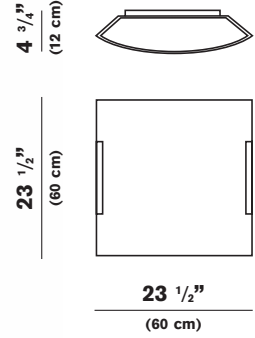

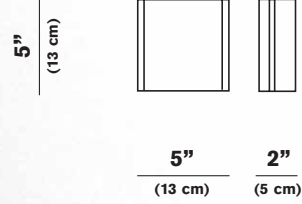

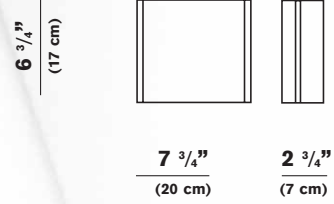

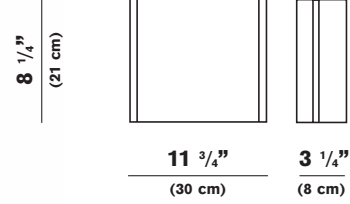
WALL, TABLE, FLOOR AND
CEILING LAMPS IN
POLISHED BRASS OR MATTE
NICKEL METAL.
OPALINE GLASS.

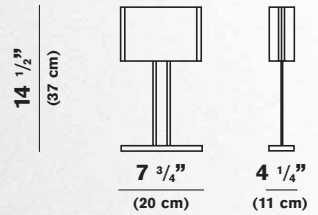
APPLIQUE, LAMPE DE TABLE,
LAMPE AU SOL ET PLAFONNIERS
EN LAITON BRILLANT OU NICKEL
SATINE.
VERRE OPALINE BLANC.

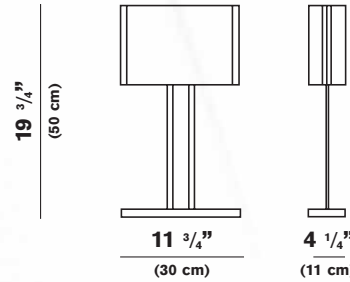
LÁMPARA DE PARED, DE MESA,
DE SUELO Y PLAFÓN DE LATÓN
LÚCIDO O NIQUEL SATINADO.
VIDRIO OPALINO BLANCO.

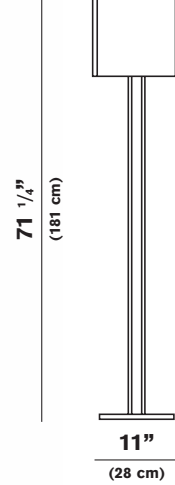
<p>D8-2027 POLISHED BRASS</p> <p>D8-2026 MATTE NICKEL FLUSH MOUNT MAX 100W T3Q (119 mm)  ADA</p>  <p>4" (10 cm)</p> <p>13 1/4" (34 cm)</p> <p>13 1/4" (34 cm)</p> <p>AVAILABLE IN COMPACT FLUORESCENT</p>	<p>D8-2029 POLISHED BRASS</p> <p>D8-2028 MATTE NICKEL FLUSH MOUNT MAX 100W T3Q (119 mm)  ADA</p>  <p>4" (10 cm)</p> <p>15 3/4" (40 cm)</p> <p>15 3/4" (40 cm)</p> <p>AVAILABLE IN COMPACT FLUORESCENT</p>	<p>D8-2031 POLISHED BRASS</p> <p>D8-2030 MATTE NICKEL FLUSH MOUNT MAX 4x100W MED. </p>  <p>4 3/4" (12 cm)</p> <p>23 1/2" (60 cm)</p> <p>23 1/2" (60 cm)</p> <p>AVAILABLE IN COMPACT FLUORESCENT</p>
<p>D8-3054 POLISHED BRASS</p> <p>D8-3053 MATTE NICKEL WALL SCONCE MAX 75W G9 ADA </p>  <p>5" (13 cm)</p> <p>5" (13 cm) 2" (5 cm)</p> <p>AVAILABLE IN COMPACT FLUORESCENT</p>	<p>D8-3056 POLISHED BRASS</p> <p>D8-3055 MATTE NICKEL WALL SCONCE MAX 100W T3Q/3 (79 mm)  ADA</p>  <p>6 3/4" (17 cm)</p> <p>7 3/4" (20 cm) 2 3/4" (7 cm)</p> <p>AVAILABLE IN COMPACT FLUORESCENT</p>	<p>D8-3058 POLISHED BRASS</p> <p>D8-3057 MATTE NICKEL WALL SCONCE MAX 150W T3Q (119 mm)  ADA</p>  <p>8 1/4" (21 cm)</p> <p>11 3/4" (30 cm) 3 1/4" (8 cm)</p> <p>AVAILABLE IN COMPACT FLUORESCENT</p>
<p>D8-4067 POLISHED BRASS</p> <p>D8-4066 MATTE NICKEL TABLE LAMP MAX 60W CAND.  or 50W XENON </p>  <p>14 1/2" (37 cm)</p> <p>7 3/4" (20 cm) 4 1/4" (11 cm)</p>	<p>D8-4069 POLISHED BRASS</p> <p>D8-4068 MATTE NICKEL TABLE LAMP MAX 150W T10 </p>  <p>19 3/4" (50 cm)</p> <p>11 3/4" (30 cm) 4 1/4" (11 cm)</p>	<p>D8-4070 MATTE NICKEL FLOOR LAMP MAX 250W T10 </p>  <p>71 1/4" (181 cm)</p> <p>11" (28 cm)</p> <p>D8-4071 POLISHED BRASS</p>

ENZO PANZERI 1998

LIBRA

LIGHT IS A MOVEMENT :
UNDERSTANDING THE
DYNAMICS LEADS TO
VISUALIZING THE LAMP AS AN
OBJECT OF FLUTTERING AND
FREE LINES.

LA LUMIERE EST EGALEMENT
MOUVEMENT: EN COMPRENDRE
LA DYNAMIQUE PORTE A
IMAGINER LA LAMPE COMME UN
OBJET AUX LIGNES PLUS
FLUCTUANTES ET LIBRES.

LA LUZ ES TAMBIÉN
MOVIMIENTO: ENTENDER LA
DINÁMICA LLEVA A IMAGINAR LA
LÁMPARA COMO UN OBJETO DE
LÍNEAS MÁS FLUCTUANTES Y
LIBRES.







LIBRA



AN IDEA OF HARMONY, A PERFECT SYMBIOSIS OF SHAPE AND FUNCTION.

UNE IDÉE D'HARMONIQUE, SYMBOSE PARFAITE ENTRE FORME ET FONCTION.

UNA IDEA DE ARMÓNICA Y PERFECTA SIMBIOSIS ENTRE FORMA Y FUNCIÓN.



LIBRA

ENZO PANZERI

TABLE, FLOOR, CEILING AND WALL LAMPS (RIGHT/LEFT) IN METALLIZED GRAY METAL. BLOWN WHITE MATTE GLASS.

LAMPE AU SOL, LAMPE DE TABLE, DE PLAFOND ET APPLIQUE (DROITE/GAUCHE) EN GRIS METALLISE. VERRE SOUFFLE BLANC SATINE.

LÁMPARA DE SUELO, DE MESA, DE TECHO Y DE PARED (DERECHA/IZQUIERDA) GRIS METALIZADO. VIDRIO SOPLADO BLANCO SATINADO.

<p>D8-2009 FLUSH MOUNT MAX 150W T10</p>  <p>11 1/2" (29 cm)</p> <p>6 1/4" (16 cm)</p>	<p>D8-2010 FLUSH MOUNT MAX 150W T10</p>  <p>17" (43 cm)</p> <p>9" (23 cm)</p>	<p>D8-3015 WALL SCONCE (LEFT) MAX 60W CAND. or 50W XENON ADA</p>  <p>9 3/4" (25 cm)</p> <p>6 1/4" (16 cm)</p> <p>2" (5 cm)</p>
<p>D8-3016 WALL SCONCE (RIGHT) MAX 60W CAND. or 50W XENON ADA</p>  <p>9 3/4" (25 cm)</p> <p>6 1/4" (16 cm)</p> <p>2" (5 cm)</p>	<p>D8-3017 WALL SCONCE (LEFT) MAX 150W T10 ADA</p>  <p>14 1/4" (36 cm)</p> <p>9" (23 cm)</p> <p>2 3/4" (7 cm)</p> <p>AVAILABLE IN COMPACT FLUORESCENT</p>	<p>D8-3018 WALL SCONCE (RIGHT) MAX 150W T10 ADA</p>  <p>14 1/4" (36 cm)</p> <p>9" (23 cm)</p> <p>2 3/4" (7 cm)</p> <p>AVAILABLE IN COMPACT FLUORESCENT</p>
<p>D8-4018 TABLE LAMP MAX 75W T10</p>  <p>16 1/2" (42 cm)</p> <p>6 3/4" (17 cm)</p>	<p>D8-4019 TABLE LAMP MAX 150W T10</p>  <p>23 1/2" (60 cm)</p> <p>9 3/4" (25 cm)</p>	<p>D8-4020 FLOOR LAMP MAX 250W T10</p>  <p>69 3/4" (177 cm)</p> <p>17" (43 cm)</p>

ENZO PANZERI 1998

LUCILLA

A NOTE OF LIGHTNESS AND IRONY FILL THE SPACE. FROM THIS CONCEPT ATMOSPHERES ARE DIFFUSED RENDERING THE HOME MORE DYNAMIC.

UNE NOTE DE LEGERETE ET D'IRONIE REMPLI L'ESPACE. ELLE DIFFUSENT DES ATMOSPHERES QUI SAVENT RENDRE LA MAISON PLUS ARDENTE.

UNA NOTA DE LEVEDAD E IRONÍA LLENA DE SÍ MISMA EL ESPACIO. DE LA CUAL SE DIFUNDEN ATMÓSFERAS QUE VUELVEN LA CASA MÁS BRILLANTE.

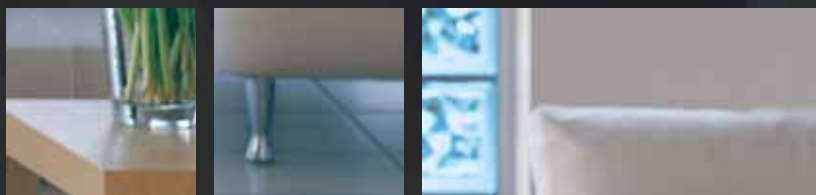





BE AMAZED, BE MOVED, SEE WITH
DIFFERENT EYES.

S'ETONNER, S'EMOTIONNER, REUSSIR A
VOIR A TRAVERS DE NOUVEAUX YEUX.

ASOMBRARSE, EMOCIONARSE, LOGRAR
VER CON OJOS NUEVOS.

LUCILLA



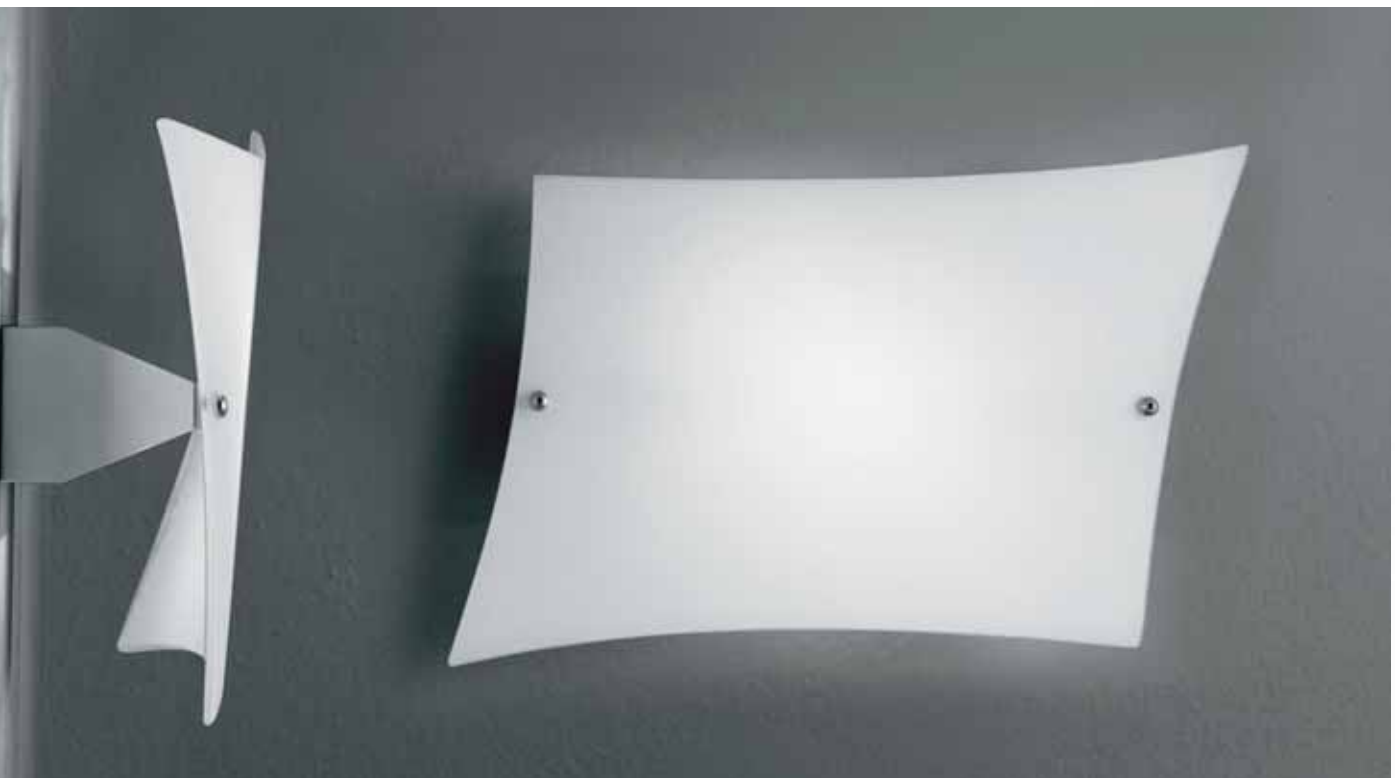
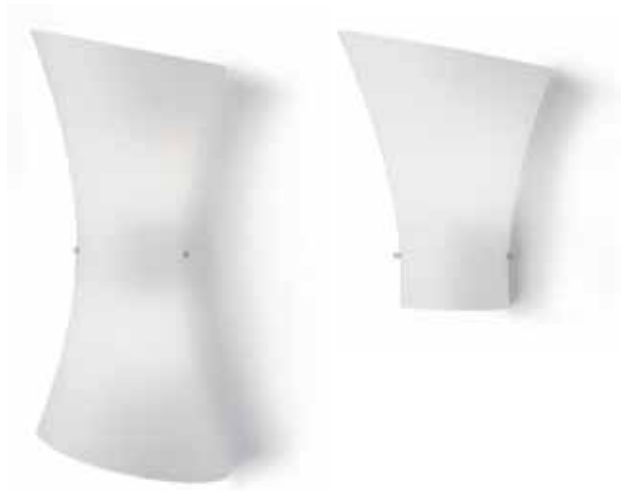











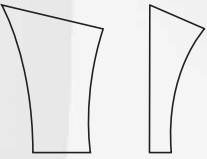

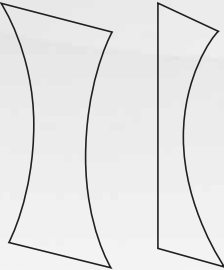

LUCILLA

ENZO PANZERI

TABLE, FLOOR AND WALL
LAMPS IN METALLIZED
GRAY METAL. BLOWN
WHITE MATTE GLASS.

LAMPE AU SOL, LAMPE
DE TABLE ET APPLIQUE GRIS
METALLISE.
VERRE SOUFFLE BLANC SATINE.

LÁMPARA DE SUELO, DE MESA Y
DE PARED GRIS METALIZADO.
VIDRIO SOPLADO BLANCO
SATINADO.

<p>D8-3000 WALL SCONCE MAX 100W MED. </p>  <p>12 1/2" (32 cm)</p> <p>9 1/2" (24 cm) 4 1/4" (11 cm)</p> <p>AVAILABLE IN COMPACT FLUORESCENT</p>	<p>D8-3001 WALL SCONCE MAX 2x100W MED. </p>  <p>20" (51 cm)</p> <p>9 1/2" (24 cm) 4 1/4" (11 cm)</p> <p>AVAILABLE IN COMPACT FLUORESCENT</p>	<p>D8-3019 WALL SCONCE MAX 150W T3Q (119 mm)  ADA</p>  <p>7 1/2" (19 cm)</p> <p>11 3/4" (30 cm) 3 1/4" (8 cm)</p>
<p>D8-4021 TABLE LAMP MAX 60W CAND.  or 50W XENON </p>  <p>17 3/4" (45 cm)</p> <p>6" (15 cm)</p>	<p>D8-4022 TABLE LAMP MAX 150W MED. </p>  <p>26 3/4" (68 cm)</p> <p>9 1/2" (24 cm)</p>	<p>D8-4023 FLOOR LAMP MAX 2x100W +2x60W MED. </p>  <p>70 3/4" (180 cm)</p> <p>18 3/4" (48 cm)</p>
<p>D8-4024 FLOOR LAMP MAX 3x150W T10 </p>  <p>67 1/4" (171 cm)</p> <p>11 3/4" (30 cm)</p>		



NOA

ENZO PANZIERI 2001

FLOOR LAMP IN MATTE
NICKEL METAL. BLOWN
WHITE MATTE GLASS.

LAMPE AU SOL EN NICKEL
SATINE. VERRE SOUFFLE
BLANC SATINE.

LÁMPARA DE SUELO DE
NÍQUEL SATINADO. VIDRIO
SOPLADO BLANCO
SATINADO.

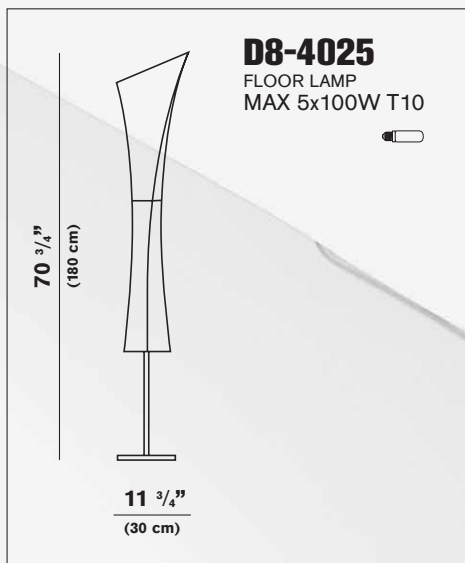

110

ZANEEN LIGHTING TEL. 1.800.388.3382 FAX 416.247.9319 E-MAIL zaneen@zaneen.com



ENZO PANZERI 2001

SPYRA

TO FEEL COMPLETELY AT HOME IN THE LIVING-SPACE IS A FEELING CREATED BY THE KNOWLEDGE THAT EVERYTHING IS PRESENTED UNDER THE RIGHT LIGHT. STARTING FROM THE LIGHT ITSELF.

SENTIR L'ESPACE DOMESTIQUE COMME VRAIMENT NOTRE, EST UNE SENSATION CREEE PAR LA CONNAISSANCE QUE TOUT SE PRESENTE SOUS LA JUSTE LUMIERE. A PARTIR DE LA LUMIERE MEME.



SENTIR EL ESPACIO DOMÉSTICO COMO VERDADERAMENTE PROPIO, ES UNA SENSACIÓN CREADA DEL SABER QUE TODO SE PRESENTA BAJO LA LUZ ADAPTA. A PARTIR DE LA MISMA LUZ.







SPYRA

METICULOUS CARE TO EVERY DETAIL
MAKES THESE LIGHTING FIXTURES
UNIQUE.

CHAQUE DETAIL EST SOIGNE DE FAÇON
A RENDRE CES OBJETS UNIQUES.

CADA DETALLE SE TOMA EN CUENTA EN
MODO DE VOLVER ÚNICOS ESTOS
OBJETOS.









SPYRA

ENZO PANZERI

FLOOR, TABLE, PENDANT
AND WALL LAMP IN MATTE
NICKEL METAL. BLOWN
WHITE MATTE GLASS.

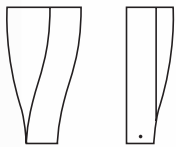
LAMPE AU SOL, LAMPE DE
TABLE, DE PLAFOND ET
APPLIQUE EN NICKEL SATINE.
VERRE SOUFFLE BLANC SATINE.

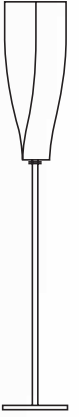
LÁMPARA DE SUELO, DE MESA,
DE TECHO Y DE PARED DE
NÍQUEL SATINADO.
VIDRIO SOPLADO BLANCO
SATINADO.

<p>D8-1011 PENDANT MAX 100W T10</p>  <p>13" (33 cm)</p> <p>7 3/4" (20 cm)</p>	<p>D8-1012 PENDANT MAX 150W T10</p>  <p>25 1/4" (64 cm)</p> <p>11 1/2" (29 cm)</p>	<p>D8-3022 WALL SCONCE MAX 150W T10</p>  <p>13" (33 cm)</p> <p>7 3/4" (20 cm)</p> <p>5" (13 cm)</p> <p>AVAILABLE IN COMPACT FLUORESCENT</p>
<p>D8-4026 TABLE LAMP MAX 75W T10</p>  <p>13 3/4" (35 cm)</p> <p>7 3/4" (20 cm)</p>	<p>D8-4027 TABLE LAMP MAX 150W T10</p>  <p>26 1/4" (67 cm)</p> <p>11 1/2" (29 cm)</p>	<p>D8-4028 FLOOR LAMP MAX 250W T10</p>  <p>70" (178 cm)</p> <p>11 1/2" (29 cm)</p>
<p>D8-4029 FLOOR LAMP MAX 250W T10</p>  <p>70 3/4" (180 cm)</p> <p>11" (28 cm)</p>		

FRIEDRICH REIFFER 1999

ZENITH

VARIATIONS IN FANTASY ARE THE WINNING THEME OF AN OBLONG FORM. A TRIBUTE TO THOSE WHO LOVE SLENDER SHAPES, SOBER INTERPRETERS OF ELEGANCE.

VARIATIONS DE LA FANTAISIE SUR LE THEME SI CAPTIVANT DE LA FORME OBLONGUE. UN HOMMAGE DEDIE A CEUX QUI AIMENT LES FORMES ELANCEES, SOBRES INTERPRETES DE L'ELEGANCE.

VARIACIONES DE LA FANTASÍA SOBRE UN TEMA TAN SUGESTIVO DE FORMA OBLONGO. UN REGALO DEDICADO A QUIEN AMA LAS FORMAS ESBELTAS, SOBRIA INTÉRPRETE DE LA ELEGANCIA.

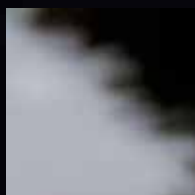





ZENITH

A SPARK OF EMOTION LIGHTS NEW
PLEASURES TO BE LIVED.

UNE ETINCELLE D'EMOTION ALLUME DE
NOUVEAUX PLAISIRS DE VIVRE.

UNA CHISPA DE EMOCIÓN ENCIENDE
NUEVOS PLACERES PARA VIVIR.





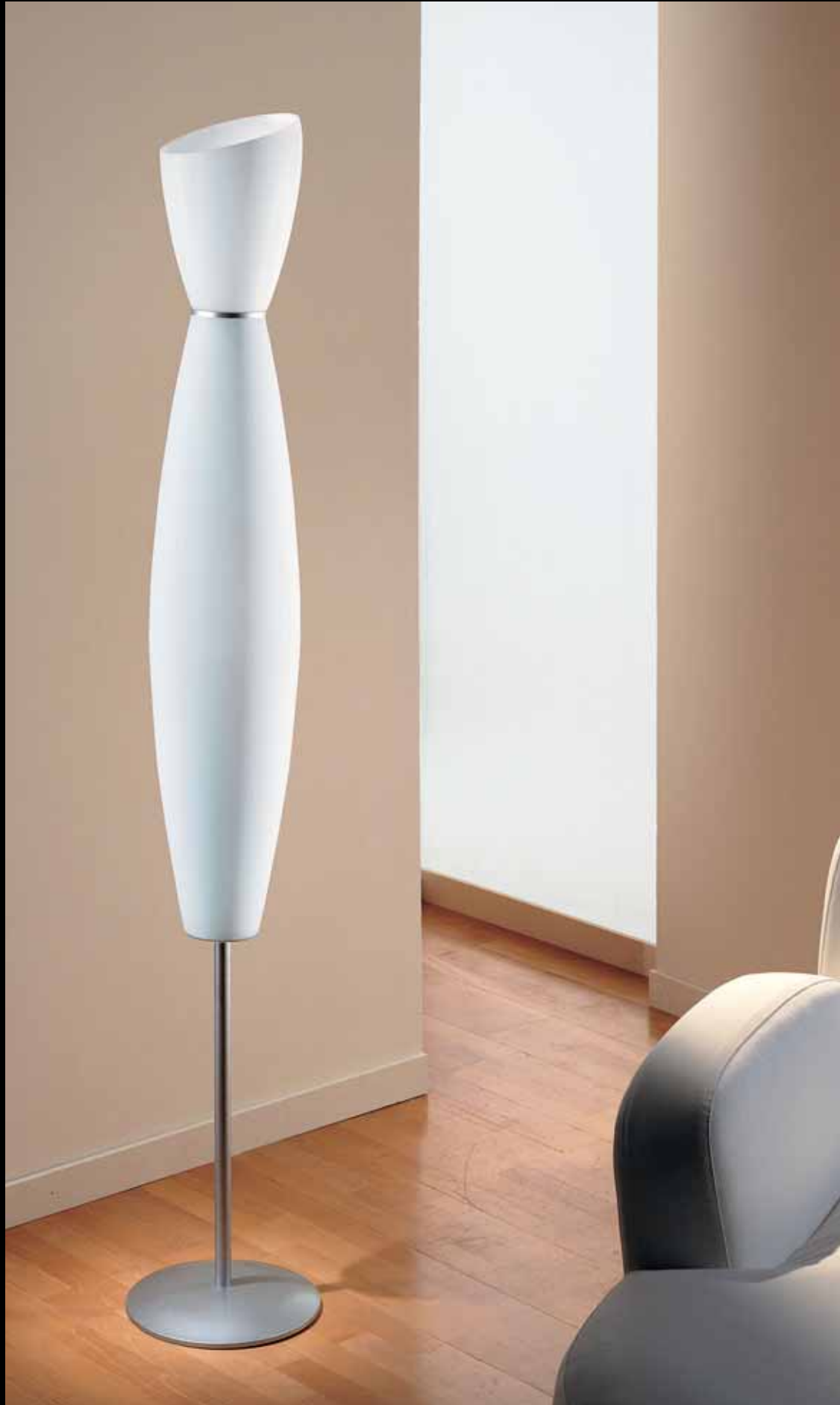



ZENITH

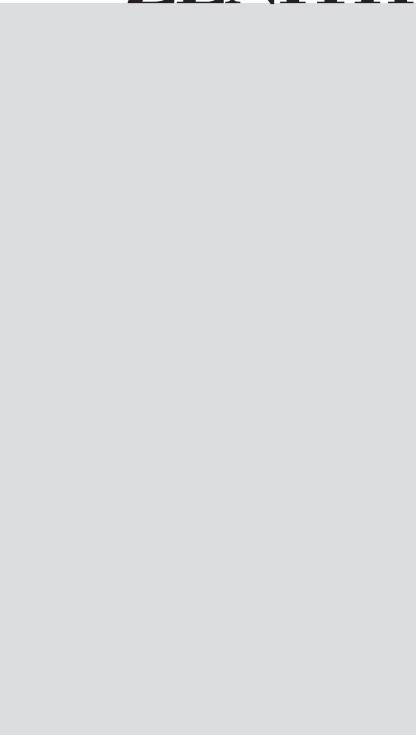









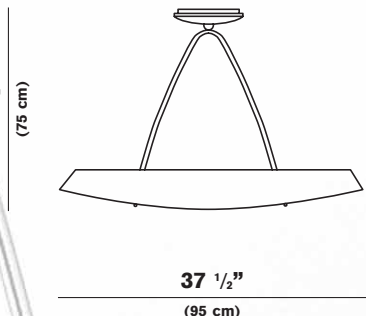

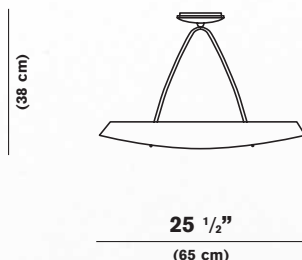

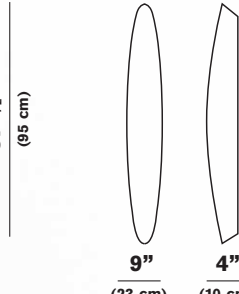

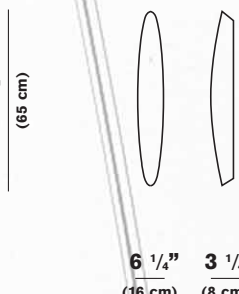

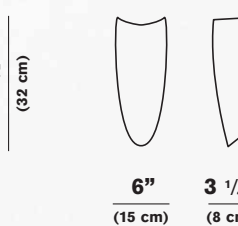

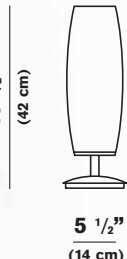
TABLE, FLOOR, CEILING AND WALL LAMPS IN METALLIZED GRAY METAL. BLOWN WHITE OR AMBER MATTE GLASS.

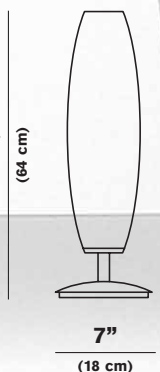
LAMPE AU SOL, LAMPE DE TABLE, DE PLAFOND ET SUSPENSIONS ET APPLIQUE EN GRIS METALLISE. VERRE SOUFFLE BLANC OU AMBRE SATINE.

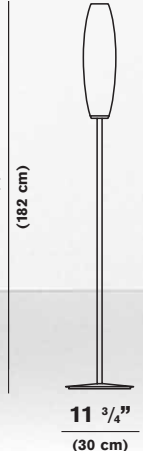
LÁMPARA DE SUELO, DE MESA, DE TECHO, SUSPENSIONES Y DE PARED COLOR GRIS METALIZADO. VIDRIO SOPLADO BLANCO O ÁMBAR SATINADO.

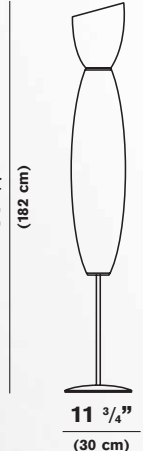
<p>D8-1044 AMBER</p> <p>D8-1013 WHITE PENDANT MAX 2x150W T3Q (119 mm) </p>  <p>29 1/2" (75 cm)</p> <p>37 1/2" (95 cm)</p> <p>AVAILABLE IN COMPACT FLUORESCENT</p>	<p>D8-2032 AMBER</p> <p>D8-2011 WHITE PENDANT MAX 1x200W T3Q (119 mm) </p>  <p>15" (38 cm)</p> <p>25 1/2" (65 cm)</p> <p>AVAILABLE IN COMPACT FLUORESCENT</p>	<p>D8-3065 AMBER</p> <p>D8-3023 WHITE WALL SCONCE MAX 2x150W T3Q (119 mm)  ADA</p>  <p>37 1/2" (95 cm)</p> <p>9" (23 cm)</p> <p>4" (10 cm)</p> <p>AVAILABLE IN COMPACT FLUORESCENT</p>
<p>D8-3066 AMBER</p> <p>D8-3024 WHITE WALL SCONCE MAX 1x200W T3Q (119 mm)  ADA</p>  <p>25 1/2" (65 cm)</p> <p>6 1/4" (16 cm)</p> <p>3 1/4" (8 cm)</p> <p>AVAILABLE IN COMPACT FLUORESCENT</p>	<p>D8-3067 AMBER</p> <p>D8-3025 WHITE WALL SCONCE MAX 150W T10 ADA </p>  <p>12 1/2" (32 cm)</p> <p>6" (15 cm)</p> <p>3 1/4" (8 cm)</p> <p>AVAILABLE IN COMPACT FLUORESCENT</p>	<p>D8-4075 AMBER</p> <p>D8-4030 WHITE TABLE LAMP MAX 75W T10 </p>  <p>16 1/2" (42 cm)</p> <p>5 1/2" (14 cm)</p>
<p>D8-4076 AMBER</p> <p>D8-4031 WHITE TABLE LAMP MAX 150W T10 </p>  <p>25 1/4" (64 cm)</p> <p>7" (18 cm)</p>	<p>D8-4077 AMBER</p> <p>D8-4032 WHITE FLOOR LAMP MAX 250W T10 </p>  <p>71 3/4" (182 cm)</p> <p>11 3/4" (30 cm)</p>	<p>D8-4078 AMBER</p> <p>D8-4033 WHITE FLOOR LAMP MAX 4x100W T10 </p>  <p>71 3/4" (182 cm)</p> <p>11 3/4" (30 cm)</p>

ENZO PANZERI 2002

WILLY

SIMPLICITY AS A TIMELESS
AESTHETIC RULE GIVES
CHARM THAT PERFECTLY FITS
IN WITH THE ELEGANCE AND
PERSONALITY OF ANY
FURNISHING CONTEXT.

LA SIMPLICITE COMME REGLE
ESTHETIQUE ETERNELLE,
OFFRE UN CHARME QUI SAIT
S'INSERER AVEC CLASSE ET
PERSONNALITE DANS
N'IMPORTE QUEL CONTEXTE
D'AMEUBLEMENT.

LA SIMPLICIDAD COMO REGLA
ESTÉTICA INTRAMONTABLE,
REGALA UN ENCANTO QUE
SABE INTRODUCIRSE CON
CLASE Y PERSONALIDAD EN
CUALQUIER CONTEXTO DE
DECORACIÓN.







WILLY

LIGHT IN HARMONY WITH AN AMBIENCE
WHERE EVERYTHING IS PERFECTLY
BALANCED.

UNE LUMIERE EN SYNTONIE AVEC UNE
AMBIANCE OU TOUT EST EQUILIBRE.

UNA LUZ EN SINTONÍA CON UN
AMBIENTE DONDE TODO ES EQUILIBRIO.







WILLY



A LIMPID HARMONIOUS SHAPE THAT TRANSMITS AESTHETIC SOFT VIBRATIONS YET INTENSE AT THE SAME TIME.

UNE FORME D'HARMONIE LIMPIDE, QUI TRANSMET DES VIBRATIONS ESTHETIQUES LEGERES ET INTENSES EN MEME TEMPS.

UNA FORMA DE LÍMPIDA ARMONÍA, QUE TRANSMITE VIBRACIONES ESTÉTICAS LEVES E INTENSAS AL MISMO TIEMPO.

WILLY

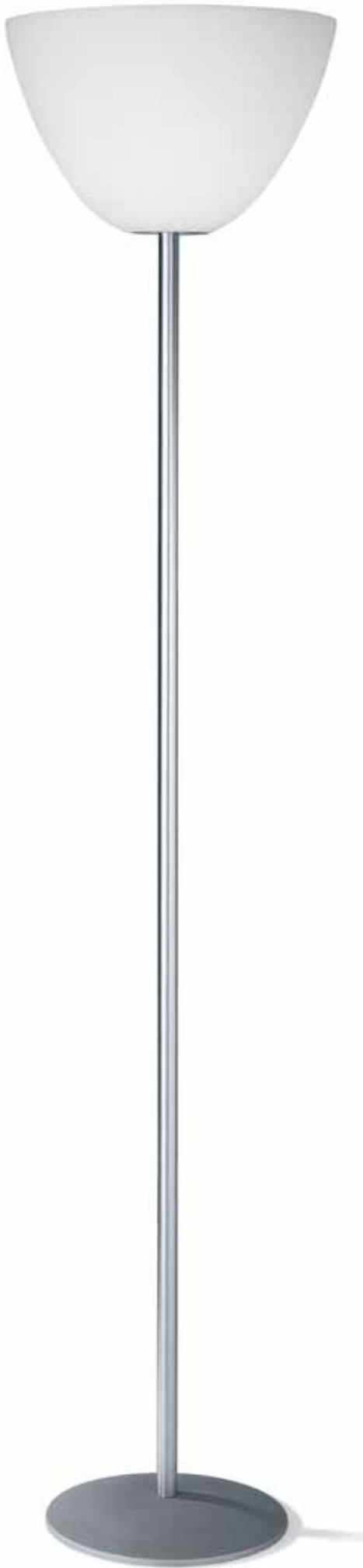

132









D8-9013 + 2 x D8-9016 + 2 x D8-1057



D8-9014 + 4 x D8-9015 + 4 x D8-1060



D8-9015
DETAIL FOR ELECTRIC CABLE PENDANTS

ACESSOIRE POUR SUSPENSION AVEC FIL ELECTRIQUE
DETALLE POR SUSPENSION CON CABLE ELECTRICO





D8-9016
DETAIL FOR STAINLESS STEEL CABLE PENDANTS

ACESSOIRE POUR SUSPENSION AVEC FIL EN ACIER
DETALLE POR SUSPENSION CON CABLE DE ACERO

BLOWN BLACK OR WHITE
PENDANTS 16CM (2 1/4 IN)
DIAMETER AND BLOWN 40CM
(15 3/4 IN) AND 60CM (23 5/8 IN)
DIAMETER GLASS PENDANTS
IN BLACK DECORATION.
METALLIZED GRAY FITTINGS.

SUSPENSION EN VERRE
SOUFFLÉ NOIR OU BLANC,
DIAMÈTRE 16 CM ET
SUSPENSIONS EN VERRE
SOUFFLÉ DÉCORÉ NOIR,
DIAMÈTRE 40 CM OU 60 CM.
MONTURES GRIS MÉTALLISÉ.

SUSPENSIÓN EN VIDRIO
SOPLADO NEGRO O BLANCO
DE 16 CM. DE DIÁMETRO Y
SUSPENSIONES DE VIDRIO
SOPLADO DECORADO NEGRO
DE 40 O 60 CM. DE DIÁMETRO.
MONTURAS EN GRIS
METALIZADO.

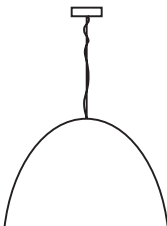
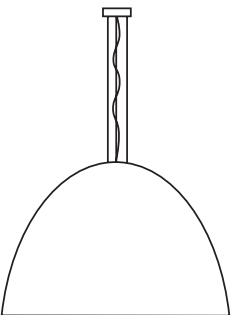
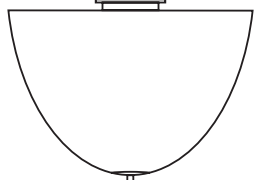
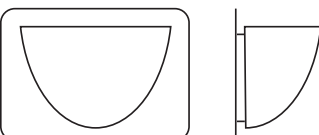
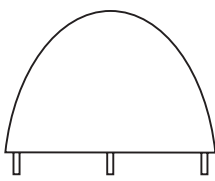
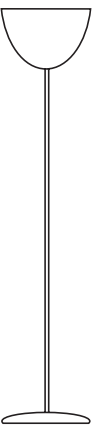
<p>D8-1060 BLACK</p>  <p>9 7/8" (25 cm)</p> <p>6 1/4" (16 cm)</p>	<p>D8-1059 WHITE PENDANT MAX 60W G9</p>  <p>11" (28 cm)</p> <p>15 3/4" (40 cm)</p>	<p>D8-1058 BLACK</p> <p>D8-1057 WHITE PENDANT MAX 150W E26</p>  <p>15 3/4" (40 cm)</p> <p>D8-1056 BLACK</p> <p>D8-1014 WHITE PENDANT MAX 3x100W MED.</p>  <p>14 5/8" (37 cm)</p> <p>23 5/8" (60 cm)</p>
<p>D8-2012 WHITE PENDANT MAX 2x100W MED.</p>  <p>15 3/4" (40 cm)</p> <p>15 3/4" (40 cm)</p>	<p>D8-3027 WHITE WALL SCNCE MAX 75W G9</p>  <p>5 1/2" (14 cm)</p> <p>7 3/4" (20 cm)</p> <p>4 1/4" (11 cm)</p>	<p>D8-4034 WHITE TABLE LAMP MAX 60W G16 1/2</p>  <p>5 1/2" (14 cm)</p> <p>6 1/4" (16 cm)</p>
<p>D8-4035 WHITE FLOOR LAMP MAX 250W T10</p>  <p>70 3/4" (180 cm)</p> <p>15 3/4" (40 cm)</p>		

SILVIA POMA 2006

MINE

EXPAND, SPREAD AND TAKE OVER THE SPACE. MINE'S STRONG PERSONALITY IS ALL OF THIS: IT WANTS TO BE NOTICED, AN IRRESISTIBLE DESIRE TO CONQUER AND SEDUCE.

S'ÉTENDRE, SE RÉPANDRE, DOMINER L'ESPACE. LA FORTE PERSONNALITÉ DE MINE EXPRIME TOUT CELA : UNE VOLONTÉ PRÉCISE DE SE FAIRE REMARQUER ET UN DÉSIR IRRÉSISTIBLE DE CONQUÊTE ET DE SÉDUCTION.

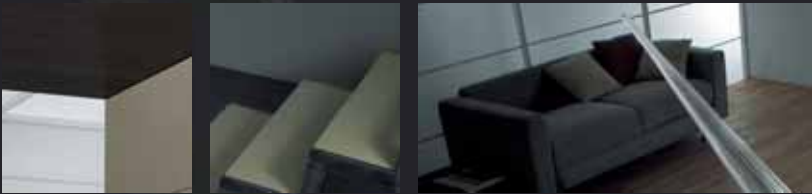

EXPANDIRSE, DIFUNDIRSE, DOMINAR EL ESPACIO. LA FUERTE PERSONALIDAD DE MINE EXPRESA TODO ESTO: UNA PRECISA VOLUNTAD DE HACERSE NOTAR, UN IRRESISTIBLE DESEO DE CONQUISTAR Y SEDUCIR.



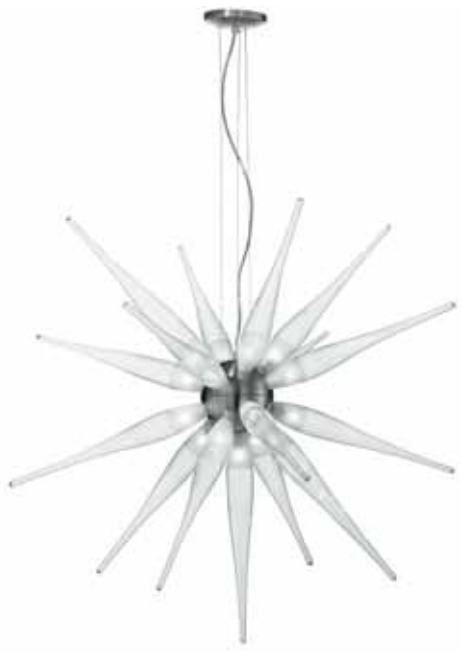
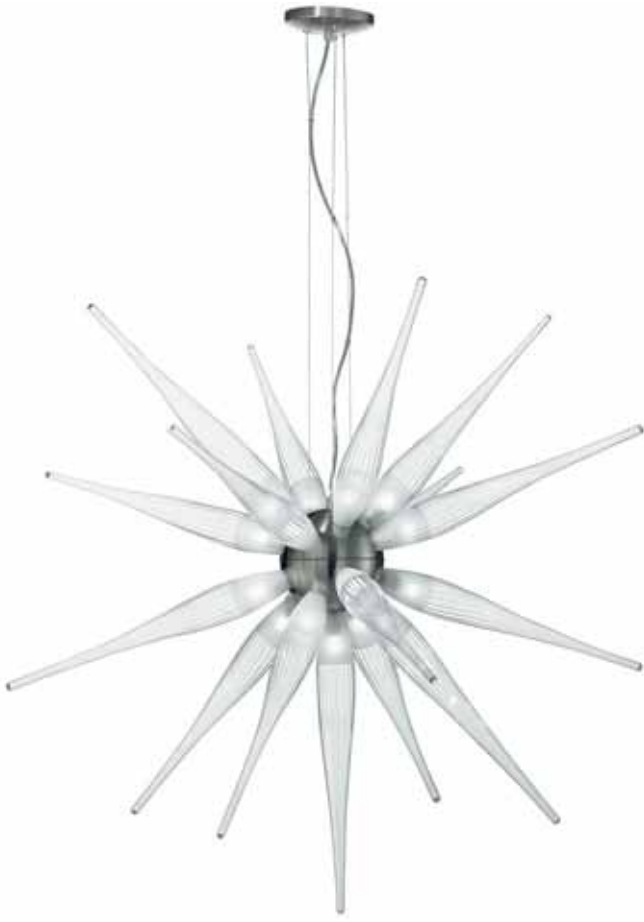

MINE











MINE

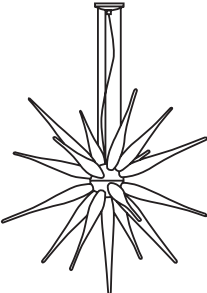
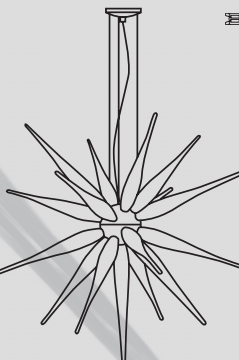

PENDANTS, WALL AND CEILING LAMPS IN NICKEL MATTE. BOROSILICATE, PARTIALLY MATTE, STRIPED HAND MADE GLASS DIFFUSERS.

LAMPES SUSPENSIONS, APPLIQUES ET PLAFONNIERS EN NICKEL SATINÉ, DOTÉS DE VERRES EN BOROSILICATE RAYÉ PARTIELLEMENT SATINÉS ET FAÇONNÉS À LA MAIN.

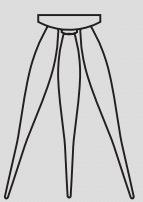
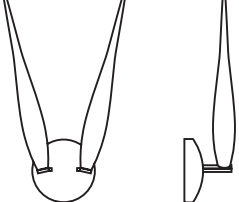
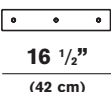
LÁMPARAS DE SUSPENSIÓN, DE PARED Y PLAFONES DE NÍQUEL SATINADO CON VIDRIOS DE BOROSILICATO RAYADO PARCIALMENTE SATINADOS Y ELABORADOS A MANO.

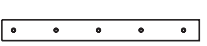
<p>D8-1064 PENDANT MAX 60W G9</p>  <p>15" (38 cm)</p> <p>Ø 2" (ø 5 cm)</p>	<p>D8-1063 PENDANT MAX 60W G9</p>  <p>15" (38 cm)</p> <p>Ø 2" (ø 5 cm)</p>	<p>D8-1065 PENDANT MAX 17x40W G9</p>  <p>24 3/8" (62 cm)</p> <p>Ø 25 5/8" (ø 65 cm)</p>
<p>D8-1066 PENDANT MAX 17x40W G9</p>  <p>30 3/8" (77 cm)</p> <p>Ø 33 1/2" (ø 85 cm)</p>	<p>D8-2053 FLUSH MOUNT MAX 6x60W G9</p>  <p>13" (33 cm)</p> <p>Ø 21 1/4" (ø 54 cm)</p>	<p>D8-2054 FLUSH MOUNT MAX 11x40W G9</p>  <p>17 3/4" (45 cm)</p> <p>Ø 32 1/4" (ø 82 cm)</p>
<p>D8-2052 FLUSH MOUNT MAX 3x60W G9</p>  <p>11 3/4" (30 cm)</p> <p>Ø 8 5/8" (ø 22 cm)</p>	<p>D8-3092 WALL SCONCE MAX 2x60W G9</p>  <p>9 1/2" (24 cm)</p> <p>3 1/2" (9 cm)</p>	<p>D8-1071 GRAY D8-1017 WHITE D8-1072 GRAY D8-1018 WHITE D8-1073 GRAY D8-1019 WHITE</p>  <p>2 1/2" (6,5 cm)</p> <p>16 1/2" (42 cm)</p>  <p>9 7/8" (25 cm)</p> <p>16 1/2" (42 cm)</p>  <p>2 1/2" (6,5 cm)</p> <p>29 7/8" (76 cm)</p>

YOHJI TERAZERI 2006

WAVE

A CURVING WAVE THAT FASCINATES OUR IMAGINATION, A MOVING IDEA THAT IS FREE TO DANCE IN SPACE GIVING IT NEW FORM, IN THE WAY ONLY A DEEP EMOTION CAN.

LA SINUOSITÉ D'UNE VAGUE QUI ENSORCELLE L'ESPRIT. UNE IDÉE EN MOUVEMENT, LIBRE DE DANSER DANS L'ESPACE ET DE LE RÉINVENTER COMME SEULE UNE ÉMOTION PROFONDE EST CAPABLE DE LE FAIRE.

LA SINUOSIDAD DE UNA OLA QUE FASCINA LA MENTE. UNA IDEA EN MOVIMIENTO. LIBRE PARA DANZAR EN EL ESPACIO Y PARA REINVENTARLO, COMO SOLO UNA EMOCIÓN PROFUNDA ES CAPAZ DE HACER.





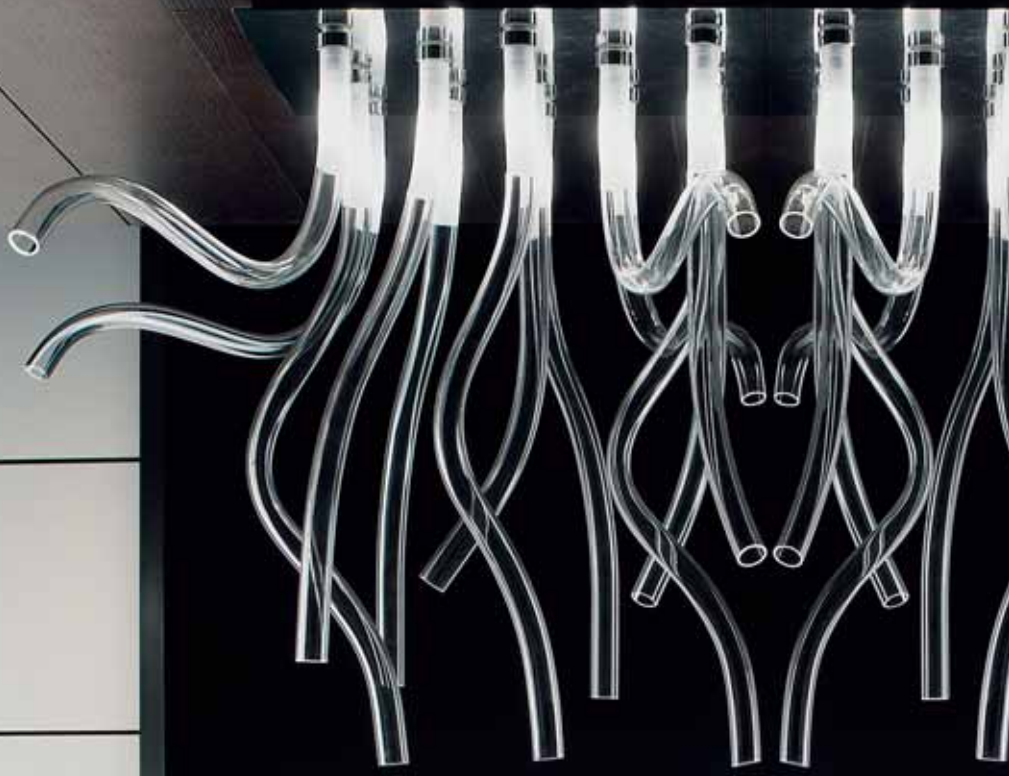



2 x D8-2056



WAVE

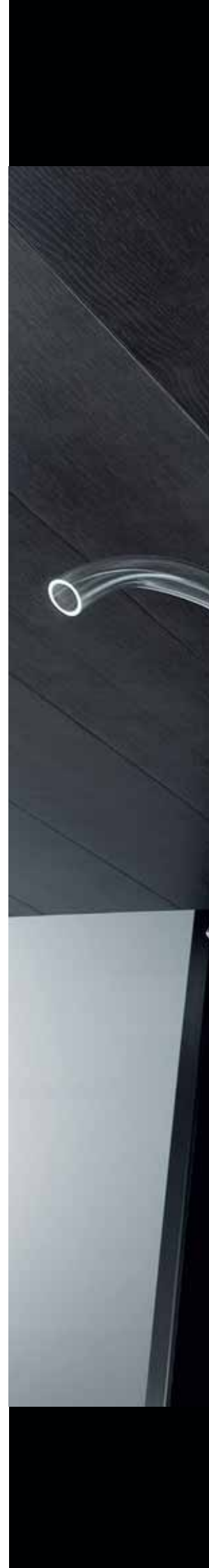

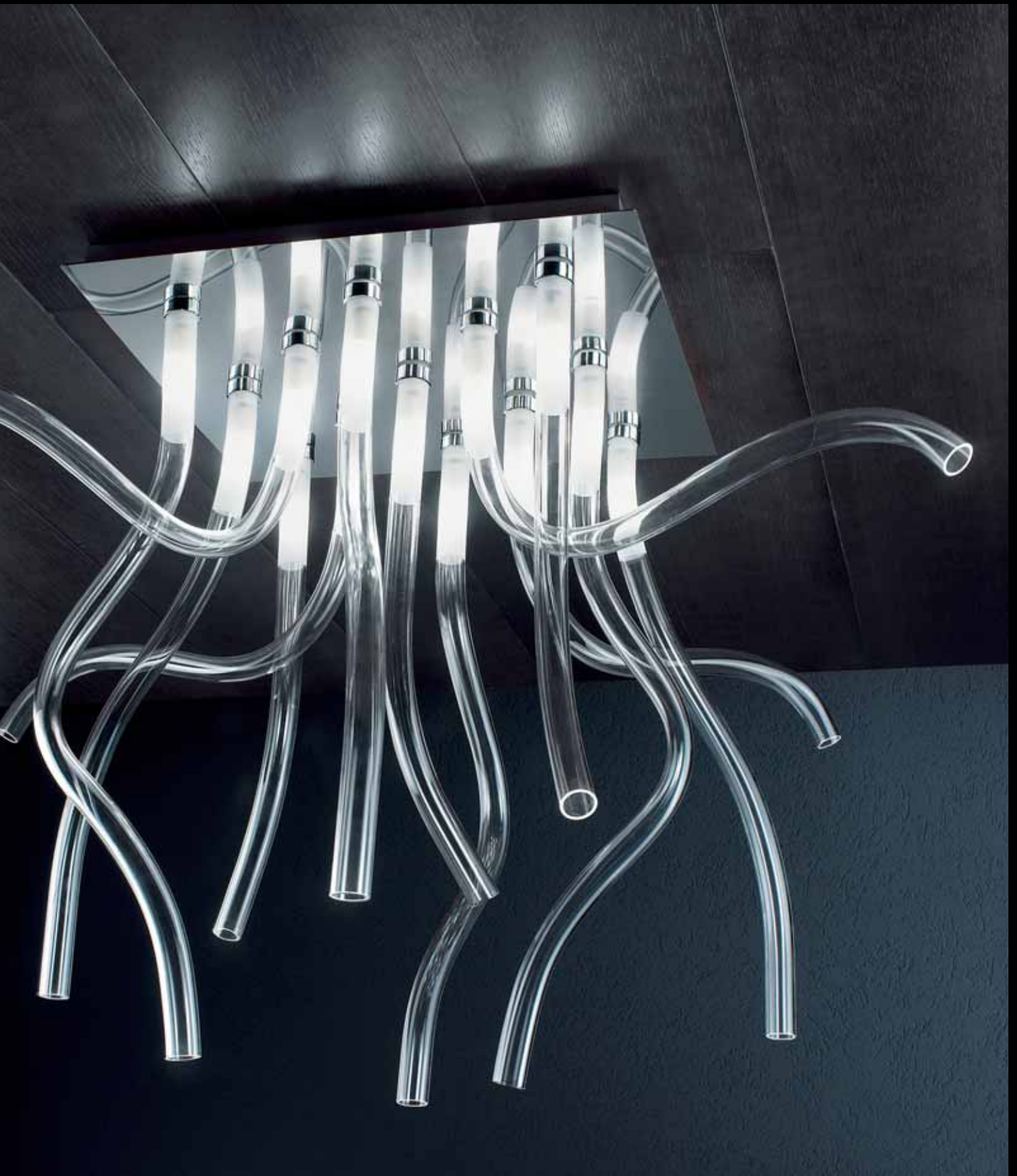



D8-1071 + 3 x D8-1070



WAVE

YOHJI TERAZERI

PENDANTS, CEILING AND WALL LAMPS IN METALLIZED GRAY METAL WITH DETAILS IN STAINLESS STEEL. BOROSILICATE, HANDWORKED AND PARTIAL MATTE GLASS SHADES.

LAMPES SUSPENSIONS, PLAFONNIERS ET APPLIQUES, VERRES EN BOROSILICATE PARTIELLEMENT SATINÉS ET FAÇONNÉS À LA MAIN. MONTURES EN MÉTAL VERNI GRIS MÉTALLISÉ AVEC DÉTAILS VISIBLES EN ACIER INOX.

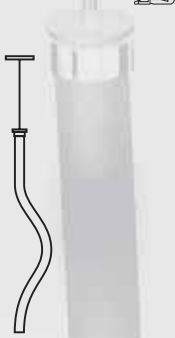
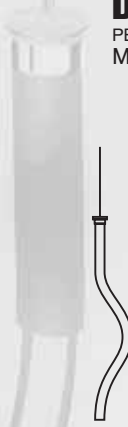
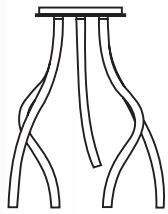
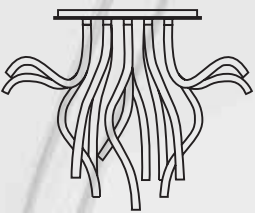
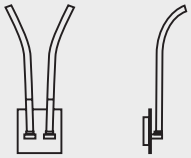
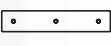
LÁMPARAS DE SUSPENSIÓN, DE TECHO Y DE PARED, VIDRIOS EN BOROSILICATO PARCIALMENTE SATINADOS Y ELABORADOS A MANO. MONTURAS DE METAL BARNIZADO GRIS METALIZADAS CON DETALLES A LA VISTA DE ACERO INOXIDABLE.

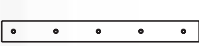
<p>D8-1069 PENDANT MAX 60W G9</p>  <p>23 ⁵/₈" (60 cm)</p> <p>3 ¹/₂" (9 cm)</p>	<p>D8-1070 PENDANT MAX 60W G9</p>  <p>23 ⁵/₈" (60 cm)</p> <p>3 ¹/₂" (9 cm)</p>	<p>D8-2055 FLUSH MOUNT MAX 5x60W G9</p>  <p>24 ³/₈" (62 cm)</p> <p>18 ⁷/₈" x 18 ⁷/₈" (48 x 48 cm)</p>
<p>D8-2056 FLUSH MOUNT MAX 13x40W G9</p>  <p>24 ³/₈" (62 cm)</p> <p>35" x 35" (89 x 89 cm)</p>	<p>D8-3097 WALL SCONCE MAX 2x60W G9</p>  <p>45 ³/₄" (45 cm)</p> <p>9 ¹/₂" (24 cm)</p> <p>8 ¹/₈" (13 cm)</p>	<p>D8-1071 GRAY D8-1017 WHITE D8-1072 GRAY D8-1018 WHITE D8-1073 GRAY D8-1019 WHITE</p>  <p>2 ¹/₂" (6,5 cm)</p> <p>16 ¹/₂" (42 cm)</p>  <p>9 ⁷/₈" (25 cm)</p> <p>16 ¹/₂" (42 cm)</p>  <p>2 ¹/₂" (6,5 cm)</p> <p>29 ⁷/₈" (76 cm)</p>

HIGHLIGHT 2005

BIRNE



STAINLESS STEEL WALL LAMPS.
CLEAR GLASS SHEETS.

LAMPE MURALE EN ACIER
INOXYDABLE. PLAQUETTES EN
VERRE TRANSPARENT.

LÁMPARA DE PARED
DE ACERO INOXIDABLE, VIDRIO
TRANSPARENTE EN PLACAS.

D8-3074

WALL SCONCE
MAX 75W G9

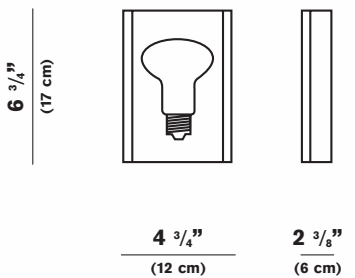

BULB INCLUDED
AVEC AMPOULES
BOMBILLA INCLUIDO



SILVIA POMA 2006

CANDLE

A FASCINATING HIGHLIGHT FOR YOUR INTERIOR FURNISHINGS. CANDLE HOLDS THE SECRET OF REAL ELEGANCE: THE PERFECT COMBINATION OF SIMPLICITY, SPIRIT AND HARMONIOUS LINES.

ÉLÉMENT D'AMEUBLEMENT FASCINANT QUI S'INTÈGRE DANS L'ESPACE ET L'ANIME, CANDLE CONNÂIT LE SECRET DE LA VÉRITABLE ÉLÉGANCE : L'ALLIANCE PARFAITE ENTRE SIMPLICITÉ, BRIO ET HARMONIE DES FORMES.

PROTAGONISTA DEL AMBIENTE COMO FASCINANTE ELEMENTO DE DECORACIÓN, CANDLE CONOCE EL SECRETO DE LA VERDADERA ELEGANCIA: UNA PERFECTA COMBINACIÓN ENTRE SENCILLEZ, VIVACIDAD Y ARMONÍA DE FORMAS.







CANDLE

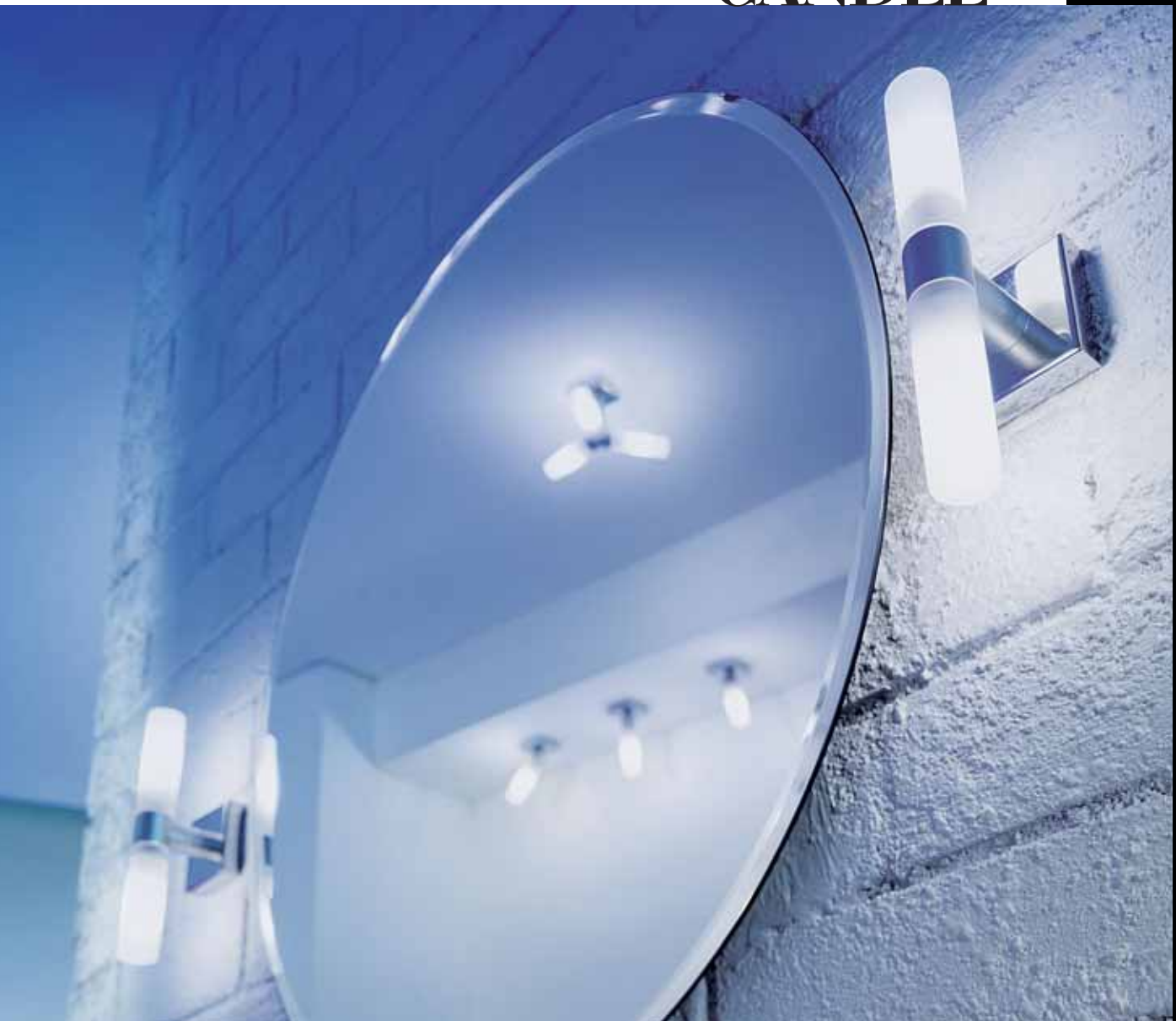

CANDLE

SILVIA POMA

CEILING/WALL LAMPS IN METALLIZED GRAY METAL AND CHROMED CANOPY BOROSILICATE GLASS DIFFUSERS (PARTIALLY MATTE).

APPLIQUES / PLAFONNIERS VERNIS GRIS MÉTALLISÉ À ROSACES DE PLAFOND CHROMÉES. VERRES EN BOROSILICATE PARTIELLEMENT SATINÉS.

DE PARED/TECHO BARNIZADAS EN GRIS METALIZADO CON ROSETONES CROMADOS. VIDRIOS DE BOROSILICATO PARCIALMENTE SATINADOS.

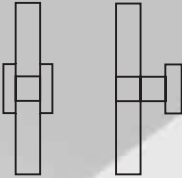
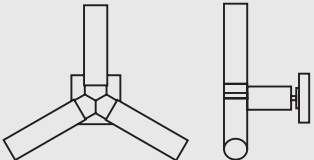
<p>D8-2049 FLUSH MOUNT MAX 60W G9</p>  <p>$2 \frac{3}{8}''$ (6 cm)</p> <p>$2 \frac{3}{8}''$ (6 cm)</p> <p>$5 \frac{1}{2}''$ (14 cm)</p>	<p>D8-2050 FLUSH MOUNT MAX 2x60W G9</p>  <p>$8 \frac{1}{4}''$ (21 cm)</p> <p>$2 \frac{3}{8}''$ (6 cm)</p> <p>$3 \frac{1}{8}''$ (8 cm)</p>	<p>D8-2051 FLUSH MOUNT MAX 3x60W G9</p>  <p>$7 \frac{1}{2}''$ (19 cm)</p> <p>$7 \frac{1}{2}''$ (19 cm)</p> <p>$4 \frac{1}{8}''$ (10,5 cm)</p>
--	--	--



SILVIA POMA 2004

JAZZ

MODULATION, RHYTHM,
HARMONY . IT'S THESE THREE
CONCEPTS THAT INSPIRED
A LIGHTING FURNISHING
WHICH CAN BE A SINGLE
ELEMENT OR BLENDED IN
AN ENSEMBLE.

MODULATION, RYTHME,
HARMONIE. C'EST A CETTE
IDEE QUE S'INSPIRE UN OBJET
LUMIERE PENSE POUR VIVRE
SEUL AINSI QUE DANS UN
ENSEMBLE.

MODULACIÓN, RITMO,
ARMONÍA. DE ESTAS IDEAS
TRAE INSPIRACIÓN UN
OBJETO LUZ PENSADO PARA
VIVIR YA SEA INDIVIDUALMENTE
O EN CONJUNTO.







JAZZ

LIGHT TO INTERPRET THE NEEDS OF
MODERN LIVING.

PRESENCE DE LUMIERE, POUR
INTERPRETER LES EXIGENCES DU
VIVRE CONTEMPORAIN.

PRESENCIA DE LUZ, PARA INTERPRETAR
LAS EXIGENCIAS DEL VIVIR
CONTEMPORÁNEO.







JAZZ





JAZZ









164

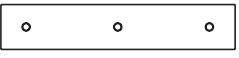
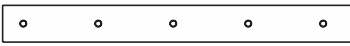
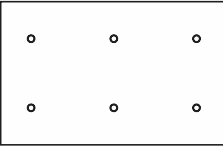

PENDANT, FLOOR, TABLE AND WALL/CEILING LAMPS GLOSS WHITE PAINT FINISH AND DOUBLE BOROSILICATE GLASS SHADES WITH A PARTIAL SATIN FINISH.

LAMPE AU SOL, LAMPE DE TABLE, APPLIQUE, PLAFONNIERS ET SUSPENSION EN GRIS MÉTALLISÉ. VERRE SOUFFLÉ BLANC SATINÉ.

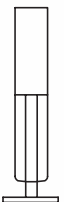
LÁMPARA DE SUELO, DE MESA, DE PARED, DE PLAFÓN Y SUSPENSIÓN GRIS METALIZADO. VIDRIO SOPLADO BLANCO SATINADO.

 <p>D8-1015 PENDANT MAX 60W G9</p> <p>13 ³/₄" (35 cm)</p> <p>2 ¹/₂" (6.5 cm)</p>	 <p>D8-1016 PENDANT MAX 60W G9</p> <p>Holder must be ordered separately. Select from D8-1017 D8-1018 D8-1019</p> <p>13 ³/₄" (35 cm)</p> <p>2 ¹/₂" (6.5 cm)</p>	<p>D8-1017 PENDANT HOLDER 3 LIGHTS Requires D8-1016 (Sold separately)</p>  <p>2 ¹/₂" (6.5 cm)</p> <p>16 ¹/₂" (42 cm)</p>
<p>D8-1018 PENDANT HOLDER 5 LIGHTS Requires D8-1016 (Sold separately)</p>  <p>2 ¹/₂" (6.5 cm)</p> <p>30" (76 cm)</p>	<p>D8-1019 PENDANT HOLDER 6 LIGHTS Requires D8-1016 (Sold separately)</p>  <p>9 ³/₄" (25 cm)</p> <p>16 ¹/₂" (42 cm)</p>	<p>D8-3028 WALL SCONCE MAX 60W G9 ADA</p>  <p>2 ¹/₂" (6.5 cm)</p> <p>10 ¹/₂" (27 cm)</p> <p>4" (10 cm)</p>
<p>D8-4036 TABLE LAMP MAX 60W G9</p>  <p>15" (38 cm)</p> <p>5 ¹/₄" (13 cm)</p>	<p>D8-4037 FLOOR LAMP MAX 75W G9</p>  <p>69 ³/₄" (177 cm)</p> <p>10 ¹/₂" (27 cm)</p>	



MARIO ORNAGHI
ENZO PANZERI 2002

BLUES

WARMTH ALSO DEVELOPS FROM A WELCOMING ATMOSPHERE, MORE INTIMATE AND REAL, RECREATED BY THE LIGHTING FURNISHINGS. LIGHTING THE LIFE OF YOUR HOME.

LA CHALEUR NAIT EGALEMENT DANS L'AMBIANCE ACCUEILLANTE, PLUS INTIME ET AUTHENTIQUE, QUE L'AMENAGEMENT DES LUMIERES SAIT CREER. EN ALLUMANT LE VECU DE LA MAISON.

EL CALOR TAMBIÉN NACE DE LA ATMÓSFERA ACOGEDORA, MÁS ÍNTIMA Y VERDADERA, QUE SABE CREAR LA PREPARACIÓN DE LA LUZ. ENCENDIENDO LAS VIVENCIAS DEL HOGAR.







BLUES

ONE GLANCE AT THE ENSEMBLE
CREATES AN IMMEDIATE EMOTIONAL
RESPONSE.

UN COUP D'ŒIL SUR L'ENSEMBLE, ET
C'EST IMMEDIATEMENT L'EMOTION.

UNA MIRADA AL CONJUNTO, Y EN
SEGUIDA ES EMOCIÓN.





BLUES

THE ELEGANT TRANSPARENCES OF THE
GLASS CASTS LIGHT ONTO
THEMSELVES.

LES TRANSPARENCES ELEGANTES DU
VERRE SE METTENT EN LUMIERE.

LA ELEGANTE TRANSPARENCIA DEL
VIDRIO SE CONVIERTE EN LUZ.





BLUES

DISCERNING STYLE AND
PERSONALITY IN ANY FURNISHING
CONTEXT.

CLASSE ET PERSONNALITE
DANS N'IMPORTE QUEL CONTEXTE
D'AMEUBLEMENT.

CLASE Y PERSONALIDAD EN
CUALQUIER ENTORNO DE
DECORACIÓN.







BLUES

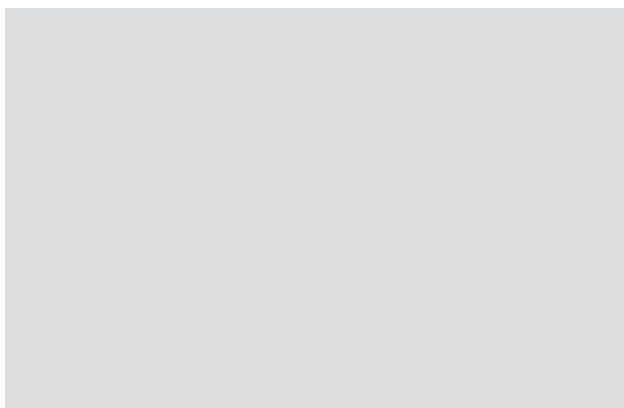



BLUES

MARIO ORNAGHI
ENZO PANZERI

PENDANTS, FLOOR,
TABLE AND WALL LAMPS IN
METALLIZED GRAY METAL.
BLOWN GLASS.

SUSPENSIONS, LAMPE
AU SOL, LAMPE DE TABLE
ET APPLIQUE EN GRIS
METALLISE ET VERRE SOUFFLE.

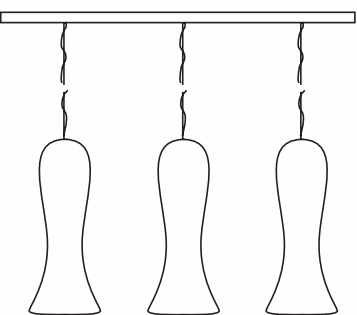
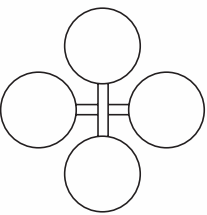
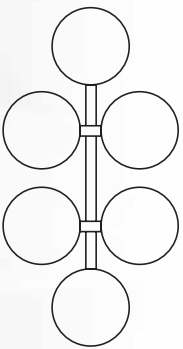
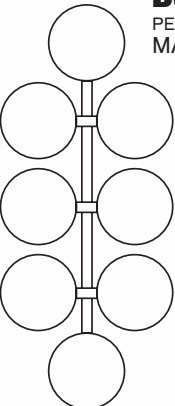
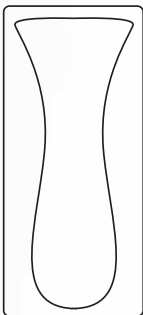
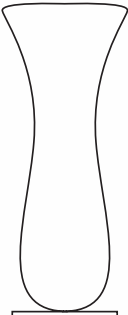
SUPENSIONES, LÁMPARA
DE SUELO, DE MESA Y DE PARED
GRIS METALIZADO
Y VIDRIO SOPLADO.

 <p>D8-1020 PENDANT MAX 60W G9</p> <p>14 1/2" (37 cm)</p> <p>6" (15 cm)</p>	 <p>D8-1021 PENDANT MAX 3x60W G9</p> <p>14 1/2" (37 cm)</p> <p>33" (84 cm)</p>	 <p>D8-1022 PENDANT MAX 4x60W G9</p> <p>16" (41 cm)</p> <p>16" (41 cm)</p>
 <p>D8-1023 PENDANT MAX 6x60W G9</p> <p>25 1/2" (65 cm)</p> <p>13 1/4" (34 cm)</p>	 <p>D8-1024 PENDANT MAX 8x60W G9</p> <p>25 1/2" (65 cm)</p> <p>25 1/2" (65 cm)</p>	 <p>D8-1025 PENDANT MAX 8x60W G9</p> <p>33" (84 cm)</p> <p>13 1/4" (34 cm)</p>
 <p>D8-3029 WALL SCONCE MAX 75W G9</p> <p>15 3/4" (40 cm)</p> <p>7 1/2" (19 cm)</p>	 <p>D8-4038 TABLE LAMP MAX 60W G9</p> <p>15 3/4" (40 cm)</p> <p>6" (15 cm)</p>	 <p>D8-4039 FLOOR LAMP MAX 75W G9</p> <p>69 3/4" (177 cm)</p> <p>10 1/2" (27 cm)</p>



ENZO PANZERI 2003

TU-B

LIGHTING POINTS EASILY LOCATED ANYWHERE, COMMENT AND ENRICH THE AMBIENCE WITH THEIR NIMBLE, AGILE PRESENCE. IN AN INSTANCE, STYLE LIGHTS UP.

DES POINTS DE LUMIERE QUI PEUVENT SE REPARTIR FACILEMENT N'IMPORTE OU, INTERPRETENT ET ENRICHISSENT L'AMBIANCE GRACE A LEUR PRESENCE DESINVOLTE ET AGILE. EN UN INSTANT, LE STYLE S'ALLUME.

CENTRO DE LUZ FÁCILMENTE DISLOCABLE HACIA CUALQUIER SITIO, COMENTAN Y ENRIQUECEN EL AMBIENTE CON SU DESENFADADA, ÁGIL PRESENCIA. EN UN INSTANTE, EL ESTILO SE ENCIENDE.

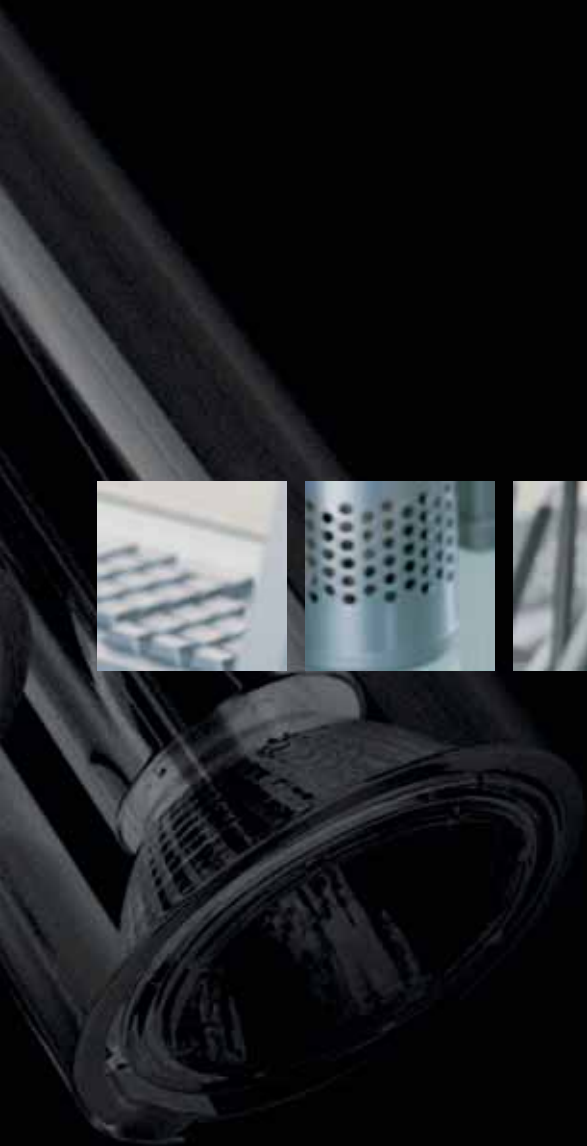





TU-B







TU-B

GLASS, METALS, CHROMES
CONTINUALLY RECREATE THE LIGHTING
FIXTURE IN A FLUTTER OF REFLECTIONS
AND LUMINESCENCE.

VERRE, METAUX, CHROMAGES,
RECREENT CONTINUELLEMENT L'OBJET
DANS UNE FLUCTUATION DE REFLETS ET
LUMINESCENCES.

VIDRIO, METALES, CROMADOS, RECREAN
CONTINUAMENTE EL OBJETO EN UNA
FLUCTUACIÓN DE REFLEJOS Y
LUMINISCENCIAS.





TU-B



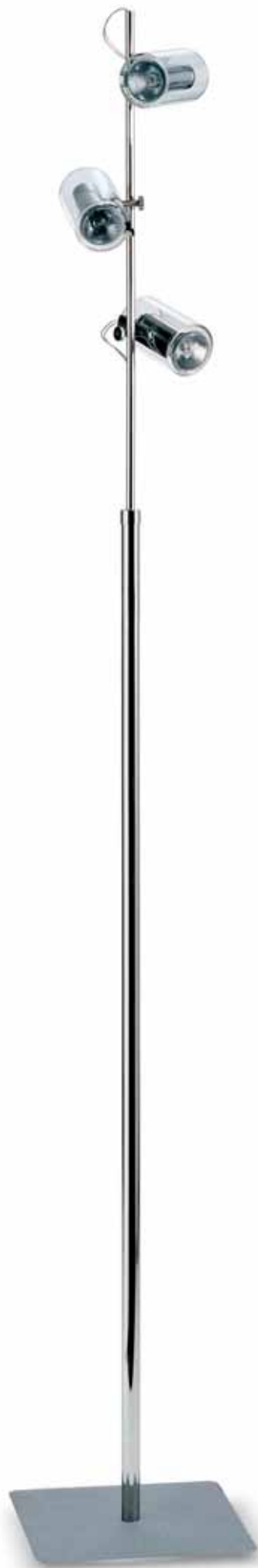



FLOOR, TABLE, WALL, CEILING
LAMPS AND PENDANTS
CHROMED METAL AND
METALIZED GRAY PARTS.
PYREX GLASS.

LAMPE AU SOL, LAMPE
DE TABLE, APPLIQUE,
PLAFONNIER ET SUSPENSIONS
EN METAL CHROME ET DETAILS
EN GRIS METALLISE. VERRE
PYREX.

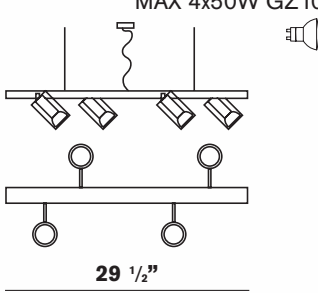
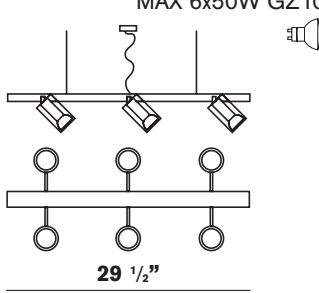
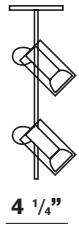
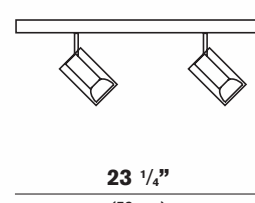
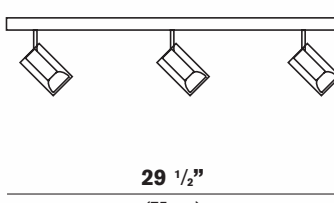
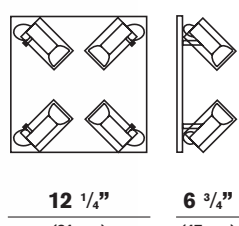
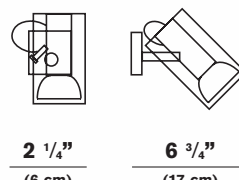
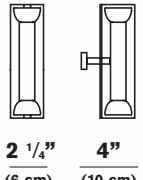
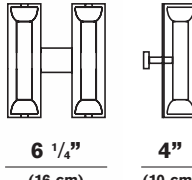
LÁMPARA DE SUELO, DE MESA,
DE PARED, PLAFÓN Y
SUSPENSIONES DE METAL
CROMADO Y DETALLES GRIS
METALIZADO. VIDRIO PÍREX.

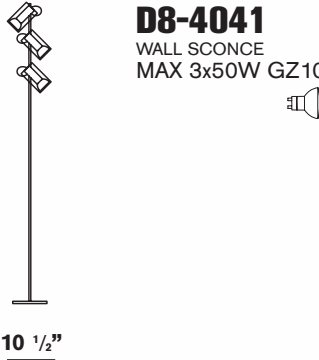
<p>D8-1026 PENDANT MAX 4x50W GZ10</p>  <p>13 1/2" (34 cm)</p> <p>29 1/2" (75 cm)</p>	<p>D8-1027 PENDANT MAX 6x50W GZ10</p>  <p>13 1/2" (34 cm)</p> <p>29 1/2" (75 cm)</p>	<p>D8-2013 FLUSH MOUNT MAX 2x50W GZ10</p>  <p>15" (38 cm)</p> <p>4 1/4" (11 cm)</p>
<p>D8-2014 FLUSH MOUNT MAX 2x50W GZ10</p>  <p>6 3/4" (17 cm)</p> <p>23 1/4" (59 cm)</p>	<p>D8-2015 FLUSH MOUNT MAX 3x50W GZ10</p>  <p>6 3/4" (17 cm)</p> <p>29 1/2" (75 cm)</p>	<p>D8-2016 FLUSH MOUNT MAX 4x50W GZ10</p>  <p>12 1/4" (31 cm)</p> <p>6 3/4" (17 cm)</p>
<p>D8-3030 WALL SCNCE MAX 50W GZ10</p>  <p>4" (10 cm)</p> <p>2 1/4" (6 cm)</p> <p>6 3/4" (17 cm)</p>	<p>D8-3031 WALL SCNCE MAX 2x50W GZ10 ADA</p>  <p>7" (18 cm)</p> <p>2 1/4" (6 cm)</p> <p>4" (10 cm)</p>	<p>D8-3032 WALL SCNCE MAX 4x50W GZ10 ADA</p>  <p>7" (18 cm)</p> <p>6 1/4" (16 cm)</p> <p>4" (10 cm)</p>
<p>D8-4040 TABLE LAMP MAX 50W GZ10</p>  <p>15 3/4" (40 cm)</p> <p>5" (13 cm)</p>	<p>D8-4041 WALL SCNCE MAX 3x50W GZ10</p>  <p>66 1/4" (168 cm)</p> <p>10 1/2" (27 cm)</p>	



ENZO PANZERI 2000

WING

A NEW FORM OF EXPRESSION
REDESIGNS THE LAMP'S
PUREST LINES RENDERING IT
THE MAIN PROTAGONIST OF THE
AMBIENCE.

UNE NOUVELLE EXPRESSIVITE
REDESSINE LA LAMPE DANS
SES LIGNES PLUS PURES, POUR
DEVENIR LA PROTAGONISTE
ABSOLUE DE L'AMBIANCE.

UNA NUEVA EXPRESIVIDAD
DISEÑA NUOVAMENTE LA
LÁMPARA EN SUS LÍNEAS MÁS
PURAS, PARA VOLVERSE
PROTAGONISTA ABSOLUTA DEL
AMBIENTE.



WING

LIGHT AND METAL ARE THE
INGREDIENTS OF THE PERFECT
BLEND OF DESIGN AND
FUNCTION.

LUMIERE ET METAL COMME
INGREDIENTS D'UN MIX ENTRE
DESIGN ET FONCTION.

LUZ Y METAL COMO
INGREDIENTES DE UN MIX ENTRE
DISEÑO Y FUNCIÓN.

190





WING MINI



WING



ESSENTIAL GEOMETRY WITH A
CLASSIC LINE CREATING NEW DESIGN
COMBINATIONS.

GEOMETRIES ESSENTIELLES AU
DESIGN FORMEL POUR INVENTER
DE NOUVEAUX ARRANGEMENTS
PROJECTUELS.

GEOMETRÍAS ESENCIALES DE DISEÑO
FORMAL PARA INVENTAR NUEVAS
COMBINACIONES PROYECTIVAS.







SIMPLE AND CLEAN LINES TO DESIGN A ROOM
WITH A NEW PERSONALITY.

LIGNES ESSENTIELLES ET NETTES POUR DESSINER
LA NOUVELLE PERSONNALITE D'UNE PIECE.

LÍNEAS ESENCIALES Y PRECISAS PARA DISEÑAR
UN CUARTO DESDE UNA NUEVA PERSONALIDAD.





WING

SOLUTIONS AND TECHNOLOGY
THAT PERFECTLY INTERPRET THE
FREEDOM OF LIVING.

SOLUTIONS ET TECHNOLOGIES
POUR UNE INTERPRETATION
PARFAITE DE LA LIBERTE
D'HABITER.

SOLUCIONES Y TECNOLOGÍA
PARA UNA PERFECTA
INTERPRETACIÓN DE LA LIBERTAD
DE HABITAR.

WING



ENZO PANZERI



CHROMED OR GRAY METAL
FLOOR, WALL LAMPS AND
PENDANTS. PYREX
PRINTED MATTE GLASS.

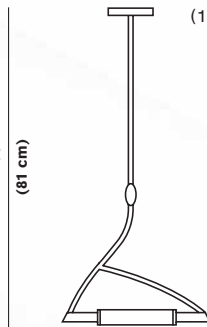
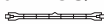
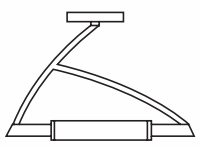
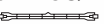

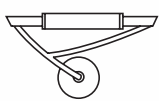
LAMPE AU SOL, LAMPE DE
PLAFOND ET APPLIQUE EN
VERSION CHROME OU GRIS
METALLISE. VERRE
BOROSILICATE
SATINE ET SERIGRAPHE.

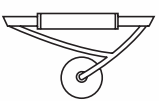

LAMPARA DE SUELO, DE
TECHO Y DE PARED EN
VERSION CROMADA O GRIS
METALIZADO. VIDRIO
BOROSILICADO
SATINADO Y SERIGRAFEADO.

<p>D8-1029 GRAY METAL</p>  <p>31 ³/₄" (81 cm)</p> <p>11 ¹/₂" (29 cm)</p>	<p>D8-1028 CHROME PENDANT MAX 200W T3Q (119 mm) </p>	<p>D8-2018 GRAY METAL</p>  <p>7 ³/₄" (20 cm)</p> <p>11 ¹/₂" (29 cm)</p>	<p>D8-2017 CHROME WALL SCONCE MAX 200W T3Q (119 mm) </p>
--	---	---	--

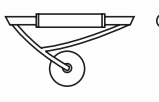
<p>D8-3034 GRAY METAL</p>  <p>6 ¹/₄" (16 cm)</p> <p>11 ¹/₂" (29 cm)</p>	<p>D8-3033 CHROME WALL SCONCE MAX 200W T3Q (119 mm) </p>  <p>7 ¹/₂" (19 cm)</p>
---	--

<p>D8-3036 GRAY METAL</p>  <p>6 ¹/₄" (16 cm)</p> <p>11 ¹/₂" (29 cm)</p>	<p>D8-3035 CHROME WALL SCONCE MAX 200W T3Q (119 mm) </p>  <p>7 ¹/₂" (19 cm)</p>
---	---

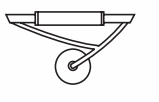
<p>D8-3060 GRAY METAL</p>  <p>4 ³/₄" (12 cm)</p> <p>8 ¹/₄" (21 cm)</p>	<p>D8-3059 CHROME WALL SCONCE MAX 150W T3Q/3 (79 mm) </p>  <p>6" (15 cm)</p>
--	--

<p>D8-3062 GRAY METAL</p>  <p>4 ³/₄" (12 cm)</p> <p>8 ¹/₄" (21 cm)</p>	<p>D8-3061 CHROME WALL SCONCE MAX 150W T3Q/3 (79 mm) </p>  <p>6" (15 cm)</p>
--	---

WING MINI

ENZO PANZERI

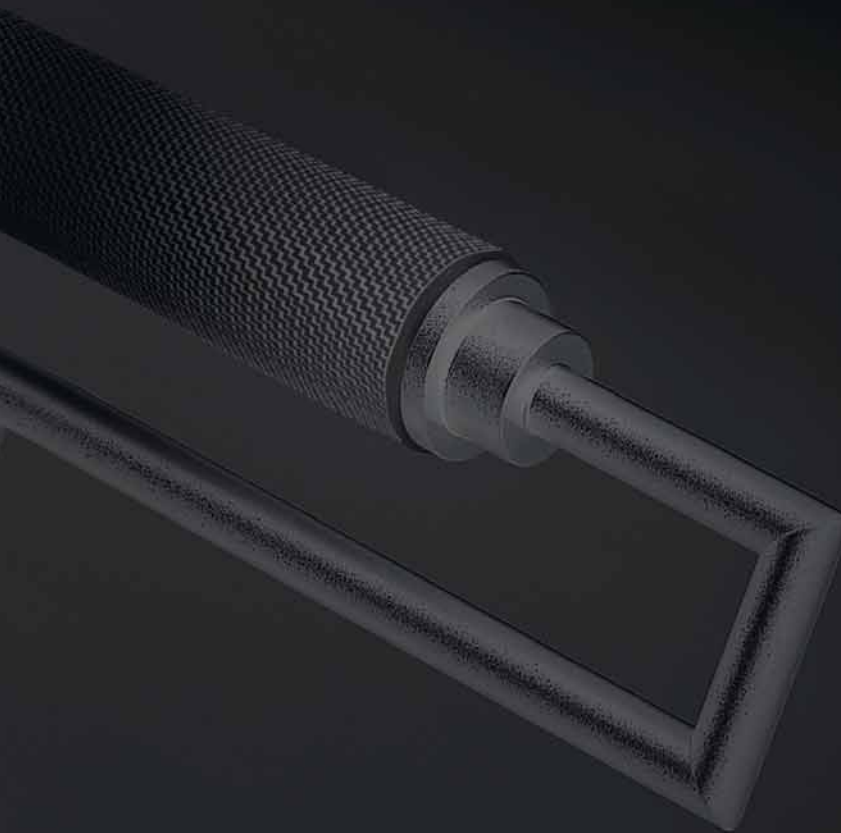

ENZO PANZERI 2004

GLIM



METALS AND GLASS IN A WIDE RANGE OF COMPOSITIONS TO FREE A SUBTLE CREATIVITY PLAYED ON EVER CHANGING SUGGESTIONS.

METAUX ET VERRE DANS UN VASTE DEVELOPPEMENT DE COMPOSITION, POUR LIBERER UNE CREATIVITE SUBTILE, QUI JOUE SUR DES SUGGESTIONS TOUJOURS DIFFERENTES.

METALES Y VIDRIO EN UN AMPLIO DESARROLLO DE COMPOSICIONES, PARA LIBRAR UNA CREATIVIDAD SUTIL, BASADAS EN SUGESTIONES SIEMPRE DISTINTAS.





GLIM



GLIM



EVERY NEW LAMP IS A NEW
INTERPRETATION OF THE CONCEPT
OF LIGHT.

CHAQUE NOUVELLE LAMPE EST UNE
NOUVELLE INTERPRETATION DU
CONCEPT DE LUMIERE.

CADA NUEVA LÁMPARA ES UNA NUEVA
INTERPRETACIÓN DEL CONCEPTO DE
LUZ.



SIMPLICITY AND COMPLEXITY HAVE FOUND A MEETING POINT: IT IS HERE, THE SECRET THAT CREATES THE ORIGINALITY OF THE DESIGN.

SIMPLICITE ET COMPLEXITE TROUVENT UN POINT DE RENCONTRE: VOICI LE SECRET QUI CREE L'ORIGINALITE DE LA FORME.

SIMPLICIDAD Y COMPLEJIDAD ENCUENTRAN UN PUNTO DE ENCUENTRO: DESDE AQUÍ EL SECRETO QUE GENERA LA ORIGINALIDAD DE LA FORMA.

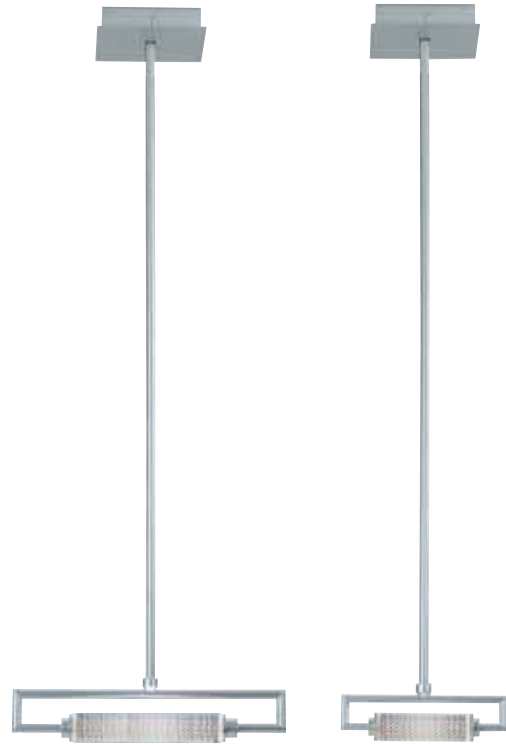

GLIM







GLIM

ENZO PANZERI

FLOOR, CEILING, WALL LAMPS
AND ADJUSTABLE PENDANTS
IN CHROME OR IN METALLIZED
GRAY METAL. PRINTED MATTE
PYREX GLASS.

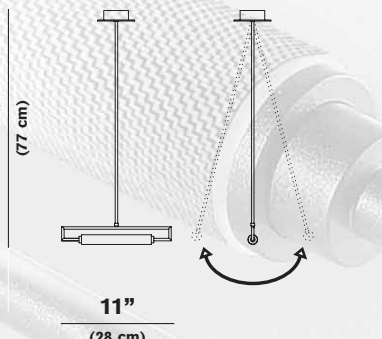

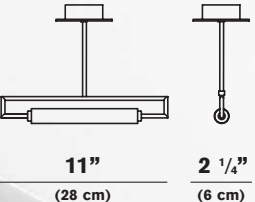

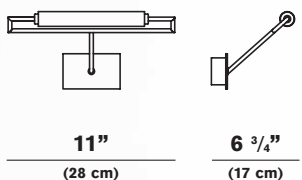
LAMPE AU SOL, POUR
PLAFONNIER, APPLIQUE ET
SUSPENSION BASCULANTE EN
VERSION CHROMEE OU GRIS
METALLISE. VERRE
BOROSILICATE SATINE ET
SERIGRAPHIE.

LÁMPARA DE SUELO, DE PLAFÓN,
DE PARED Y SUSPENSIÓN
BASCULANTE EN VERSIÓN
CROMADA O GRIS METALIZADO.
VIDRIO BOROSILICADO SATINADO
Y SERIGRAFEADO.

<p>D8-1031 GRAY METAL</p> <p>D8-1030 CHROME PENDANT MAX 200W T3Q (119 mm) </p>  <p>30 1/4" (77 cm)</p> <p>11" (28 cm)</p>	<p>D8-2020 GRAY METAL</p> <p>D8-2019 CHROME FLUSH MOUNT MAX 200W T3Q (119 mm) </p>  <p>7 3/4" (20 cm)</p> <p>11" (28 cm)</p> <p>2 1/4" (6 cm)</p>	<p>D8-3038 GRAY METAL</p> <p>D8-3037 CHROME WALL SCONCE MAX 200W T3Q (119 mm) </p>  <p>7 3/4" (20 cm)</p> <p>11" (28 cm)</p> <p>6 3/4" (17 cm)</p>
---	--	--

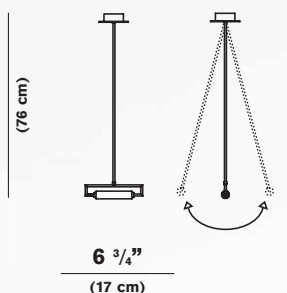
GLIM MINI

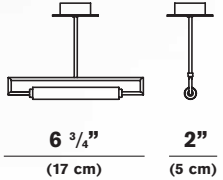
ENZO PANZERI

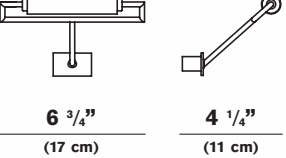
<p>D8-1041 GRAY METAL</p> <p>D8-1040 CHROME PENDANT MAX 75W G9 </p>  <p>30" (76 cm)</p> <p>6 3/4" (17 cm)</p>	<p>D8-2025 GRAY METAL</p> <p>D8-2024 CHROME PENDANT MAX 75W G9 </p>  <p>5 1/2" (14 cm)</p> <p>6 3/4" (17 cm)</p> <p>2" (5 cm)</p>	<p>D8-3052 GRAY METAL</p> <p>D8-3051 CHROME PENDANT MAX 75W G9 </p>  <p>5 1/2" (14 cm)</p> <p>6 3/4" (17 cm)</p> <p>4 1/4" (11 cm)</p>
---	---	--

ENZO PANZERI 2002

LOOP

THE LIVING SPACE REDESIGNED
BY LIGHT: A THRILLING
CHALLENGE TO SEIZE AND WIN
THROUGH THE PLEASURE OF
FREE CREATIVITY.

L'ESPACE HABITABLE
REDESSINE PAR LA LUMIERE: UN
DEFI PASSIONNANT, A CAPTER
ET VAINCRE A TRAVERS LE
PLAISIR DE LA LIBRE
CREATIVITE.

EL ESPACIO HABITABLE
REDISEÑADO POR LA LUZ: UN
DESAFÍO APASIONANTE, PARA
CAPTAR Y VENCER A TRAVÉS
DEL PLACER DE LA LIBRE
CREATIVIDAD.







LOOP

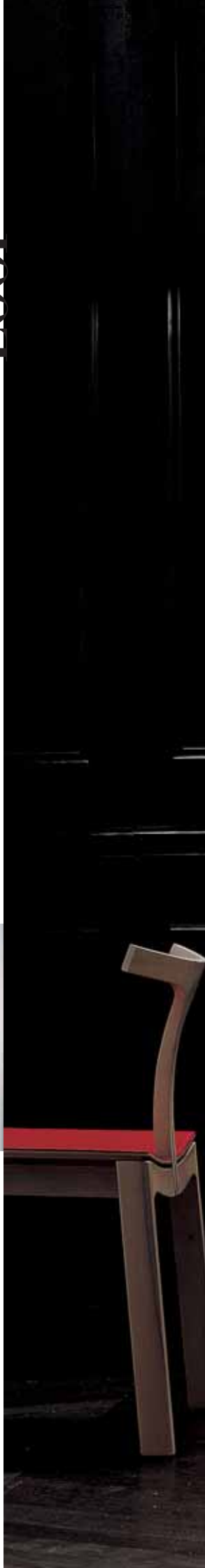





TO DEVELOP A CONCEPT INTO
AN OBJECT WITH SIMPLICITY AND
RIGOR.

DU CONCEPT PARVENIR A
L'OBJET, AVEC SIMPLICITE ET
RIGUEUR.

DESDE EL CONCEPTO LLEGAR
HASTA EL OBJETO, CON
SIMPLICIDAD Y RIGOR.

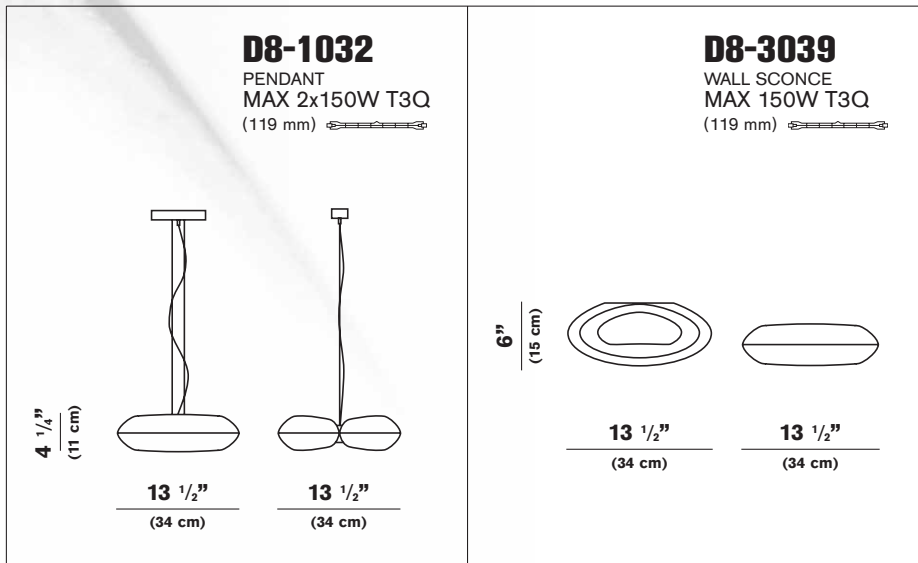

ENZO PANZERI 2003

PLANET

DESIGN EXPRESSIONS THAT LOOK TO THE FUTURE TO OFFER NEW POSSIBILITIES OF LIVING AND REPRESENTING THE LIVING-SPACE. ARE MARK OF UNIQUE STYLE.

EXPRESSIONS DU DESIGN QUI SE TOURNE VERS LE FUTUR, POUR OFFRIR A L'ESPACE DE NOUVELLES POSSIBILITES D'ETRE VECU ET REPRESENTE. A L'ENSEIGNE D'UN STYLE UNIQUE.

EXPRESIONES DE DISEÑO QUE MIRAN HACIA EL FUTURO, PARA OFRECER AL ESPACIO NUEVAS POSIBILIDADES PARA SER VIVIDO Y REPRESENTADO. A LA INSIGNIA DE UN ESTILO ÚNICO.

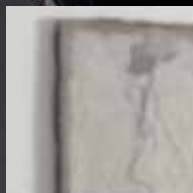



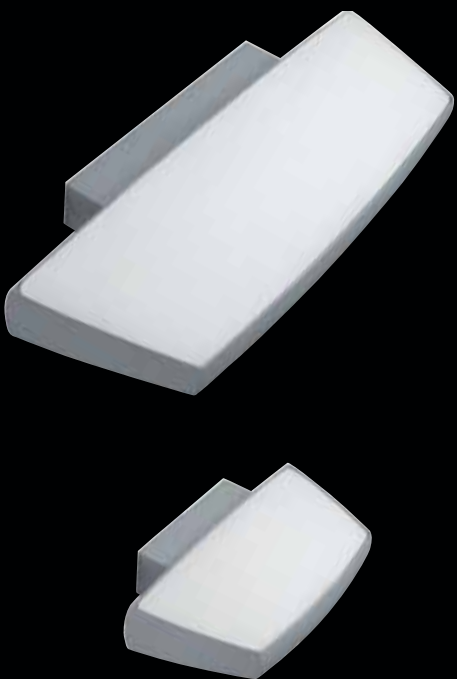







PLANET

ENZO PANZERI

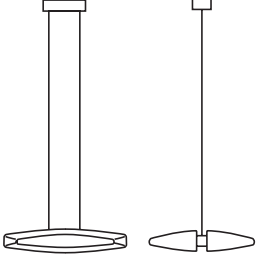
ADJUSTABLE, PENDANTS,
TABLE, FLOOR, CEILING AND
WALL LAMPS IN METALLIZED
GRAY METAL. CURVED MATTE
GLASS. FLUORESCENT VERSION
WITH ELECTRONIC BALLAST.

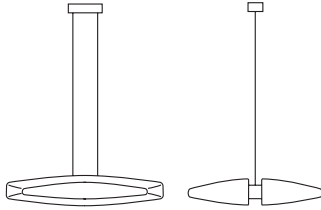
SUSPENSIONS BASCULANTES,
LAMPE AU SOL, LAMPE
DE TABLE, DE PLAFOND ET
APPLIQUE EN GRIS METALLISE.
VERRE COURBE SATINE.
VERSION FLUORESCENTE AVEC
REACTEUR ELECTRONIQUE.

SUSPENSIONES BASCULANTES,
LÁMPARA DE SUELO,
DE MESA, DE TECHO Y
DE PARED COLOR GRIS
METALIZADO.
VIDRIO CURVADO SATINADO.
VERSIÓN FLUORESCENTE CON
REACTOR ELECTRÓNICO.

<p>D8-1033 PENDANT MAX 2x150W T3Q (119 mm) </p>  <p>2 3/4" (7 cm)</p> <p>9 3/4" (25 cm) 10 1/2" (27 cm)</p>	<p>D8-1035 PENDANT MAX 2x36W FLUO. </p>  <p>3 1/4" (8 cm)</p> <p>19 3/4" (50 cm) 14 1/4" (36 cm)</p>	<p>D8-3040 WALL SCONCE MAX 150W T3Q (119 mm) </p>  <p>2 3/4" (7 cm)</p> <p>9 3/4" (25 cm) 6" (15 cm)</p>
<p>D8-3042 WALL SCONCE MAX 36W FLUO. </p>  <p>3 1/4" (8 cm)</p> <p>19 3/4" (50 cm) 7 3/4" (20 cm)</p>		

SILVIA POMA 2003

BLISSY

A PERSONAL CHOICE AS EVERYONE HAS A DIFFERENT WAY OF LIVING IN THEIR HOME. A PHILOSOPHY FOR JOURNEYING THROUGH NEW AND UNEXPECTED HARMONIES.

UN CHOIX INDIVIDUEL PARCE QUE CHACUN VIT SA MAISON DE MANIERE DIFFERENTE. UNE PHILOSOPHIE POUR ENTREPRENDRE UN VOYAGE AU SEIN D'HARMONIES NOUVELLES ET INATTENDUES.

UNA ELECCIÓN INDIVIDUAL YA QUE CADA UNO VIVE LA CASA DE MODO DIVERSO. UNA FILOSOFÍA PARA EMPRENDER UN VIAJE EN NUEVAS, INESPERADAS ARMONÍAS.









SUFFUSED ATMOSPHERES, AMBER
COLORED REFLECTIONS, LIGHT
BECOMES FURNISHING.

ATMOSPHERES VOILEE,
REFLETS AMBRES, LA LUMIERE
EST AMEUBLEMENT.

ATMÓSFERAS DIFUSAS,
REFLEJOS DE COLOR ÁMBAR,
LA LUZ ES DECORACIÓN.

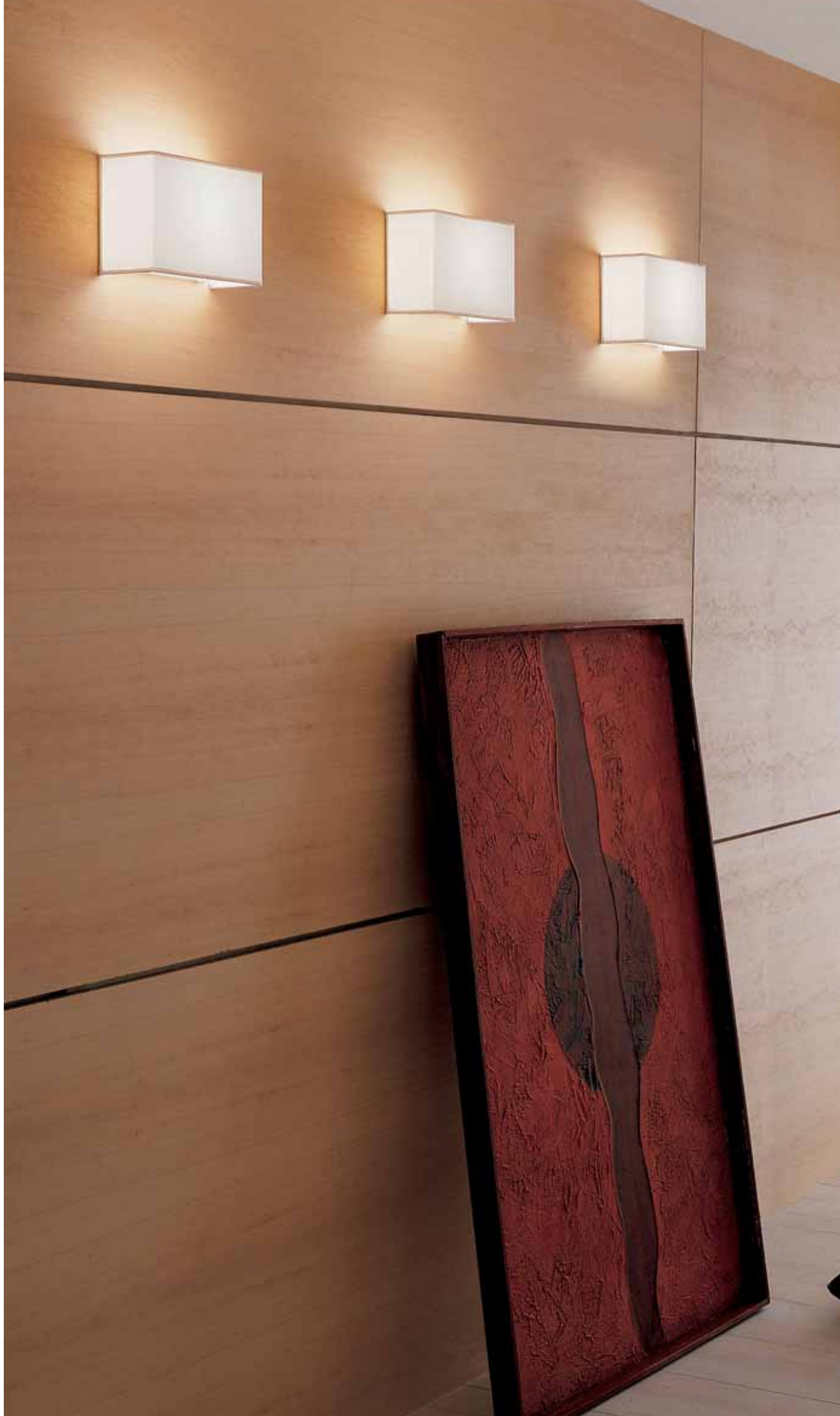



BLISSY

A RANGE OF SOLUTIONS THAT SOLVE,
AND FURNISH, PERFECTLY BALANCED
FUSIONS.

UNE SERIE DE SOLUTIONS QUI
RESOLVENT, MEUBLENT, EPATENT,
POUR DES FUSIONS PARFAITEMENT
CALIBREES.

UN ALCANCE DE SOLUCIONES QUE
RESUELVEN, DECORAN, MARAVILLAN,
PARA FUSIONES PERFECTAMENTE
CALIBRADAS.



ADJUSTABLE HEIGHT
ADJUSTABLE HEIGHT

ADJUSTABLE HEIGHT

ADJUSTABLE HEIGHT

REGLABLE EN HAUTEUR
REGULABLE EN ALTURA

PENDANT FIXTURE SOBER IN
DESIGN, A SOFT LIGHT FOR CREATING
NEW OBJECT-AMBIENT EMOTIONS.

UNE SUSPENSION AU DESIGN SOBRE,
UNE LUMIERE SOUPLE POUR DE NOUVELLES
EMOTIONS OBJET-AMBIANCE.

UNA SUSPENSIÓN DE DISEÑO
SOBRIO, UNA LUZ SUAVE PARA NUEVAS
EMOCIONES OBJETO-AMBIENTE.











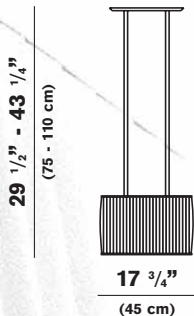
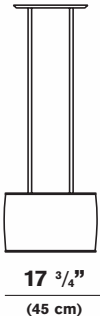
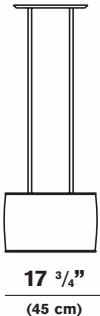

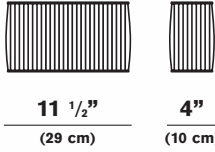
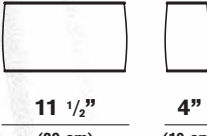
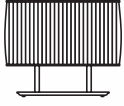

BLISSY

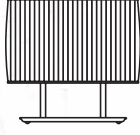
SILVIA POMA

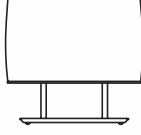
PENDANT, FLOOR, TABLE AND WALL LAMP IN METALLIZED GRAY OR BLOWN METAL. FIREPROOF IVORY PLATED OR WHITE LAMP SHADE

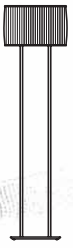
SUSPENSION, LAMPE AU SOL, LAMPE DE TABLE ET APPLIQUE EN GRIS METALLISE OU BRUN METALLISE. ABAT-JOUR IGNIFUGE EN PLISSEIVOIRE OU BLANC.

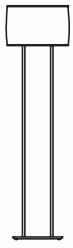
SUSPENSIÓN, LÁMPARA DE SUELO, DE MESA Y DE PARED GRIS METALIZADO O MARRÓN METALIZADO. PANTALLA PLISADA MARFIL O PANTALLA BLANCA IGNÍFUGA.

<p>D8-1037 METALLIC BROWN</p>  <p>29 1/2" - 43 1/4" (75 - 110 cm)</p> <p>17 3/4" (45 cm)</p>	<p>D8-1036 GRAY METAL PENDANT MAX 150W MED.</p>  <p>29 1/2" - 43 1/4" (75 - 110 cm)</p> <p>17 3/4" (45 cm)</p>	<p>D8-1039 METALLIC BROWN</p>  <p>29 1/2" - 43 1/4" (75 - 110 cm)</p> <p>17 3/4" (45 cm)</p> <p>D8-1038 GRAY METAL PENDANT MAX 150W MED.</p>  <p>D8-3043 WALL SCONCE MAX 100W MED. ADA</p>  <p>7" (18 cm)</p> <p>11 1/2" (29 cm)</p> <p>4" (10 cm)</p> <p>AVAILABLE IN COMPACT FLUORESCENT</p>
<p>D8-3045 WALL SCONCE MAX 75W MED. ADA</p>  <p>7" (18 cm)</p> <p>11 1/2" (29 cm)</p> <p>4" (10 cm)</p> <p>AVAILABLE IN COMPACT FLUORESCENT</p>	<p>D8-4049 METALLIC BROWN</p>  <p>11 1/2" (29 cm)</p> <p>11 1/2" (29 cm)</p> <p>D8-4048 GRAY METAL TABLE LAMP MAX 60W MED.</p> 	<p>D8-4051 METALLIC BROWN</p>  <p>11 1/2" (29 cm)</p> <p>11 1/2" (29 cm)</p> <p>D8-4050 GRAY METAL TABLE LAMP MAX 60W MED.</p> 
<p>D8-4053 METALLIC BROWN</p>  <p>17" (43 cm)</p> <p>17 3/4" (45 cm)</p> <p>D8-4052 GRAY METAL TABLE LAMP MAX 150W MED.</p> 	<p>D8-4055 METALLIC BROWN</p>  <p>17" (43 cm)</p> <p>17 3/4" (45 cm)</p> <p>D8-4054 GRAY METAL TABLE LAMP MAX 150W MED.</p> 	
<p>D8-4057 METALLIC BROWN</p>  <p>65 1/4" (166 cm)</p> <p>17 3/4" (45 cm)</p> <p>D8-4056 GRAY METAL FLOOR LAMP MAX 150W MED.</p> 	<p>D8-4059 METALLIC BROWN</p>  <p>65 1/4" (166 cm)</p> <p>17 3/4" (45 cm)</p> <p>D8-4058 GRAY METAL FLOOR LAMP MAX 150W MED.</p> 	

TEAM DESIGN
RESTYLING 2003

CLASSIC

A BALANCED DESIGN MARKED BY THE MASTER'S ABILITY IN REVIVING A CLASSIC THEME, CREATES SHAPES THAT ARE DESTINED TO STAND THE TEST OF TIME AND SHINE WITH ELEGANCE AND PERSONALITY.

L'EQUILIBRE PROJETUEL, FONDE SUR LA REVISION SAVANTE D'UN THEME CLASSIQUE, CREE DES FORMES DESTINEES A DURER DANS LE TEMPS ET A BRILLER PAR LEUR ELEGANCE ET PERSONNALITE.

EL EQUILIBRIO PROYECTUAL, MARCADO EN LA SABIA REEXAMINACIÓN DE UN TEMA CLÁSICO, CREA FORMAS DESTINADAS A DURAR EN EL TIEMPO Y A BRILLAR POR ELEGANCIA Y PERSONALIDAD.







A SUBTLE, MEASURED BEAUTY, THAT KNOWS HOW TO IMPOSE ITSELF IN A WIDE VARIETY OF FURNISHING CONTEXTS.

UNE BEAUTE DISCRETE, MODEREE, QUI SAIT S'IMPOSER DANS LES CONTEXTES D'AMEUBLEMENT LES PLUS DIVERS.

UNA BELLEZA DISCRETA, DIMENSIONADA, QUE SABE IMPONERSE EN LOS DIVERSOS ENTORNOS DE DECORACIÓN.















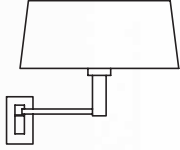

CLASSIC

TEAM DESIGN

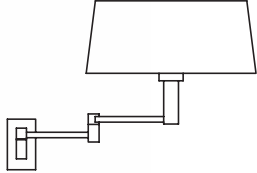
EXTENDING FLOOR, TABLE AND WALL LAMP IN POLISHED BRASS AND CHROME. WHITE FIREPROOF SHADE.

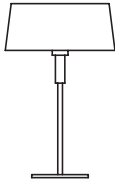
LAMPE AU SOL EXTENSIBLE, LAMPE DE TABLE, ET APPLIQUE EN LAITON BRILLANT OU CHROMÉ POLI AVEC ABAT-JOUR IGNIFUGE BLANC.

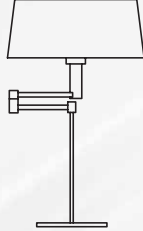
LÁMPARA DE SUELO EXTENSIBLE, DE MESA, Y DE PARED DE LATÓN LÚCIDO O CROMADO CON PANTALLA BLANCA IGNÍFUGA.

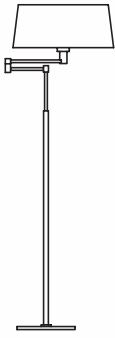
<p>D8-3047 POLISHED BRASS</p> <p>D8-3048 CHROME WALL SCONCE MAX 75W MED. </p>  <p>10 1/4" (26 cm)</p> <p>Ø 10 1/2" (Ø 27 cm)</p> <p>12 1/2" (32 cm)</p>	<p>D8-3049 POLISHED BRASS</p> <p>D8-3050 CHROME WALL SCONCE MAX 75W MED. </p>  <p>11 1/2" (29 cm)</p> <p>Ø 10 1/2" (Ø 27 cm)</p> <p>19 1/4" (49 cm)</p>	<p>D8-4060 POLISHED BRASS</p> <p>D8-4061 CHROME TABLE LAMP MAX 75W MED. </p>  <p>15 1/4" (39 cm)</p> <p>Ø 10 1/2" (Ø 27 cm)</p>
<p>D8-4062 POLISHED BRASS</p> <p>D8-4063 CHROME TABLE LAMP MAX 75W MED. </p>  <p>19 3/4" (50 cm)</p> <p>Ø 11 3/4" (Ø 30 cm)</p> <p>21 3/4" (55 cm)</p>	<p>D8-4064 POLISHED BRASS</p> <p>D8-4065 CHROME FLOOR LAMP MAX 100W MED. </p>  <p>51 1/4" - 67" (130 - 150 cm)</p> <p>Ø 15 3/4" (Ø 40 cm)</p> <p>25 1/4" (64 cm)</p>	

TEAM DESIGN 2006

CARRÉ

A MODERN CLASSIC. AN ITEM THAT TELLS YOU ABOUT ITSELF AND ITS OWNER. THIS IS WHY A CREATION OF LIGHT LIKE CARRÉ IS DESTINED TO LAST FOR A LONG TIME.

UN CLASSIQUE CONTEMPORAIN, UN OBJET QUI SAIT PARLER DE SA MANIÈRE D'ÊTRE, MAIS ÉGALEMENT DE CELLE DE CELUI QUI LE POSSÈDE. VOILÀ POURQUOI UNE CRÉATION LUMINAIRE TELLE QUE CARRÉ EST DESTINÉE À ÊTRE PÉRENNE.

UN CLÁSICO CONTEMPORÁNEO, ES UN OBJETO QUE SABE CONTAR NO SÓLO SU PROPIO MODO DE SER, SINO TAMBIÉN EL DE QUIÉN LO POSEE. HE AQUÍ PORQUE, UNA CREACIÓN DE LUZ COMO CARRÉ ESTÁ DESTINADA A DURAR EN EL TIEMPO.

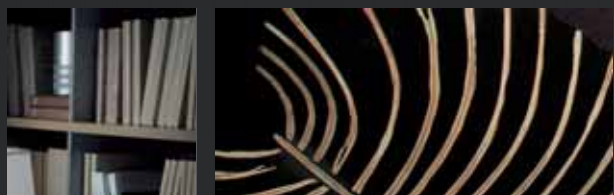





CARRÉ

TEAM DESIGN 2006

TABLE AND ADJUSTABLE WALL
LAMPS IN CHROME PLATED
BRASS. SQUARE WHITE
FIREPROOF LAMPSHADE.

LAMPE DE TABLE ET APPLIQUE
EXTENSIBLE EN LAITON
CHROMÉ AVEC ABAT-JOUR
CARRÉ IGNIFUGE BLANC.

LÁMPARA DE MESA Y DE PARED
EXTENSIBLE DE LATÓN
CROMADO CON PANTALLA
CUADRADA IGNÍFUGA BLANCA.

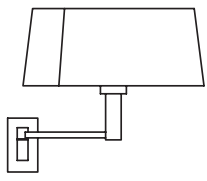
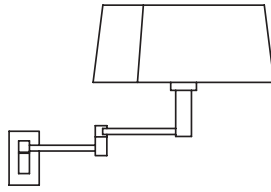
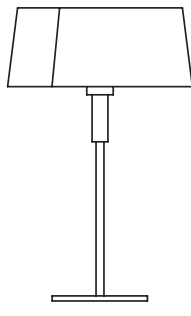
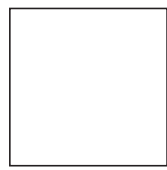
<p>D8-3090 WALL SCONCE MAX 75W E26</p>  <p>11" (28 cm)</p> <p>10 1/4" (26 cm)</p> <p>15 3/4" (40 cm)</p>	<p>D8-3091 WALL SCONCE MAX 75W E26</p>  <p>11" (28 cm)</p> <p>11 3/8" (29 cm)</p> <p>23 5/8" (60 cm)</p>	<p>D8-4092 TABLE LAMP MAX 75W MED.</p>  <p>19 1/4" (49 cm)</p> <p>11" (28 cm)</p>
<p>D8-9017</p>  <p>9 1/2" x 9 1/2" (24 x 24 cm)</p> <p>GLASS SCREEN FOR SHADE ÉCRAN POUR ABAT-JOUR DEFENSA POR PANTALLA</p>		

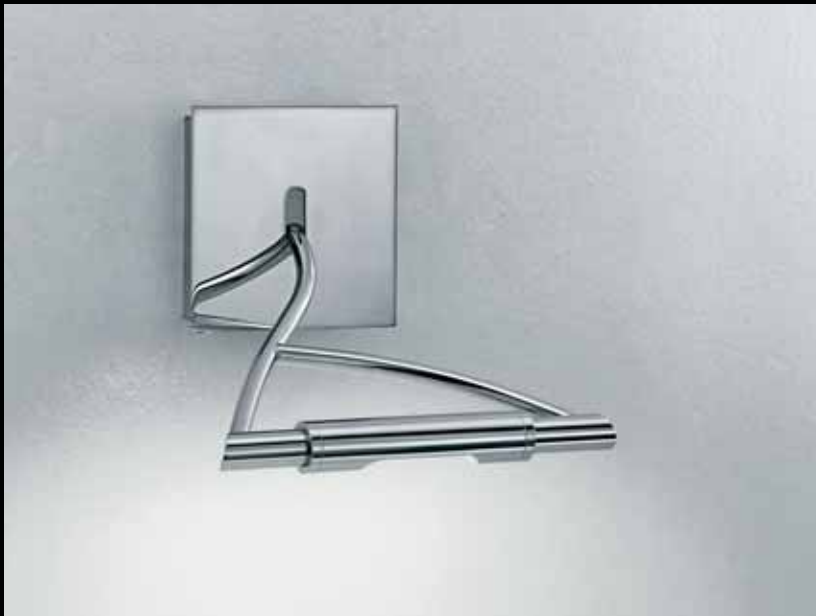

S.POMA 2002

PICTURE LIGHTS

SPECIAL ARTICLES TO LIGHT UP PICTURES, MIRRORS AND SO ON.

ARTICLE SPÉCIALE POUR ILLUMINER DES PEINTURE, MIROIR, ET PLUS.

ARTICULOS PARA ILUMINAR DES PICTURAS, ESPEJOS, Y MÁS.



PICTURE LIGHTS



PICTURE LIGHT

S.POMA 2002

SPECIAL ARTICLES TO LIGHT UP PICTURES, MIRRORS AND SO ON.

ARTICLE SPÉCIALE POUR ILLUMINER DES PEINTURE, MIROIR, ET PLUS.

ARTICULOS PARA ILUMINAR DES PICTURAS, ESPEJOS, Y MÁS.

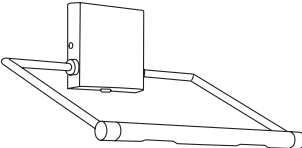
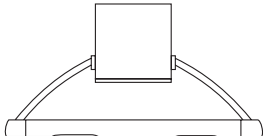
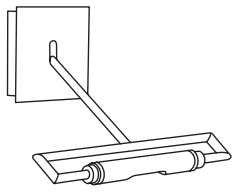
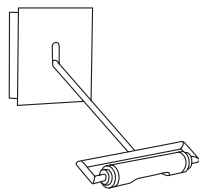
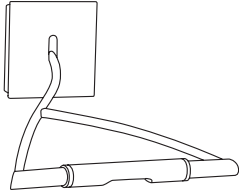
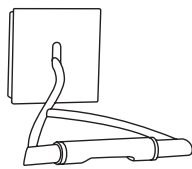
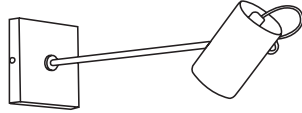
<p>D8-5000 CHROME</p> <p>D8-5001 BRASS WALL SCONCE MAX 2x40W G9</p>  <p>9 1/2" (24 cm)</p> <p>13" (33 cm)</p>	<p>D8-5002 CHROME</p> <p>D8-5003 BRASS WALL SCONCE MAX 2x40W G9</p>  <p>8 3/4" (22 cm)</p> <p>13 3/4" (35 cm)</p>	<p>D8-5004 CHROME</p> <p>D8-5005 BRASS WALL SCONCE MAX 40W G9</p>  <p>9 1/2" (24 cm)</p> <p>10 1/2" (27 cm)</p>
<p>D8-5006 CHROME</p> <p>D8-5007 BRASS WALL SCONCE MAX 40W G9</p>  <p>10" (25 cm)</p> <p>6 1/2" (16,5 cm)</p>	<p>D8-5008 CHROME</p> <p>D8-5009 BRASS WALL SCONCE MAX 40W G9</p>  <p>10" (25 cm)</p> <p>11 1/2" (29 cm)</p>	<p>D8-5010 CHROME</p> <p>D8-5011 BRASS WALL SCONCE MAX 40W G9</p>  <p>9" (23 cm)</p> <p>8 1/4" (21 cm)</p>
<p>D8-5012 GRAY/CHROME WALL SCONCE MAX 50W GZ10</p>  <p>4 1/2" (11 cm)</p> <p>18 1/4" (46 cm)</p>		

OFFSET

DECENTRAGE - DESCENTRADO



D8-9003
GREY METAL
GRIS METALLISE
GRIS METALIZADO

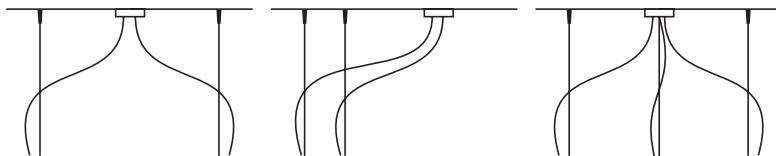

D8-9004
GREY METAL
GRIS METALLISE
GRIS METALIZADO

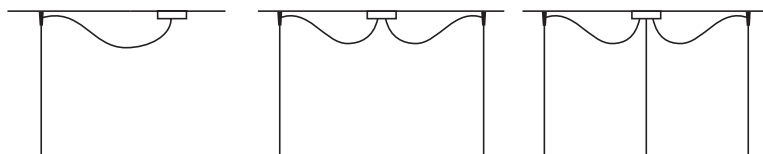

D8-9007
GREY METAL
GRIS METALLISE
GRIS METALIZADO

D8-9008
NICKEL
NICKEL
NÍQUEL

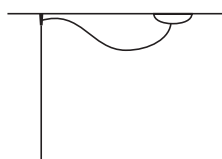

D8-9009
GREY METAL
GRIS METALLISE
GRIS METALIZADO

D8-9010
NICKEL
NICKEL
NÍQUEL

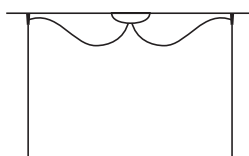

D8-9011
GREY METAL
GRIS METALLISE
GRIS METALIZADO

D8-9012
NICKEL
NICKEL
NÍQUEL

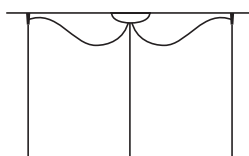

LIGHT BULBS

AMPOULES - FOCOS

Halogen 120V

G9



E12



E26-T10



GU10



GZ10



R7S-T3Q (119 mm)

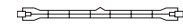

R7S-T3Q/3 (79 mm)

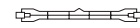

Halogen 12V

GY6.35



Incandescent

E12 - G16 1/2 Candelabra



E12-B10 Candelabra



E26 Medium



E26 Chrome Bottom



Compact Fluorescent

G24 D3



2G11



G24 Q2



E26 Dulux EL Longlife



BRANDS

MARQUES - MARCAS



Approved by CSA for CANADIAN & US Safety Standards.

ADA

The Americans with Disabilities Act.



Fixture meets standard EN 60598-1.
Luminaires selon standard EN 60598-1.
Lampára correspondiente a la norma EN 60598-1



The Italian Quality Mark Institute is an official body to guarantee and check that all equipment conforms with EC norms (34-21).
Le marque de qualité italien IMQ garantit la conformité des appareils aux normes CE (34-21).
Istituto del "Marchio Italiano di Qualità" IMQ es organo autorizado que garantiza y controla que les lamparas eran conforme a la norma CE (34-21).



Low-energy consumption bulbs can be fitted.
Il est possible d'installer des ampoules à faible consommation d'énergie.
Posibilidad de instalar lamparas de bajo consumo.



The fixture can be applied on surfaces normally inflammable.
Lampe qui peut être installée surfaces normalment infiammables.
Aparado para ser instalado en superficies normalmente inflamables.



Fixture class II.
Luminaire classe II.
Aparado de clase II.



Fixture class III
Luminaire classe III
Aparado de clase III

IP20

Index protection.
Degré de protection.
Grado di protección.

ACCESSORY

WHITE OR METALLIZED GRAY TRACK WITH SPECIAL POLYCARBONATE STRIPS TO COVER HOLES. ADJUSTABLE FOR VARIOUS SERIES OF OUR COLLECTIONS.

BARRE EN BLANC OU GRIS MÉTALLISÉ AVEC BAGUETTES SPÉCIALES EN POLYCARBONATE CACHE ADAPTABLE À DIFFÉRENTS MODÈLES DANS NOTRE CATALOGUE.

BARRA EN BLANCO O GRIS METALIZADO CON LISTAS ESPECIALES DE POLICARBONATO CUBRE AGUJEROS ADAPTABLE A DIVERSOS MODELOS DE NUESTRO CATÁLOGO.

 <p>CE</p>	<p>ITEMS CAN BE MATCHED TO D8-9013 OR D8-9014 WITH D8-9015 DETAIL</p> <p>ARTICLES COMBINABLES AVEC D8-9013 OU D8-9014 AVEC ACCESSOIRE D8-9015</p> <p>ARTÍCULOS COMBINABLES CON D8-9013 O D8-9014 CON DETALLE D8-9015</p>	 <p>BLUES</p>	 <p>DOMINO</p>	 <p>JAZZ</p>	 <p>MINE</p>	 <p>WAVE</p>
 <p>CA</p>	<p>ITEMS CAN BE MATCHED TO D8-9013 OR D8-9014 WITH D8-9016 DETAIL</p> <p>ARTICLES COMBINABLES AVEC D8-9013 OU D8-9014 AVEC ACCESSOIRE D8-9016</p> <p>ARTÍCULOS COMBINABLES CON D8-9013 O D8-9014 CON DETALLE D8-9016</p>	 <p>ALVI</p>	 <p>BLOW</p>	 <p>BLOW MINI</p>	 <p>DELPHINA</p>	 <p>DENIS</p>
		 <p>OLINDA</p>	 <p>SPYRA</p>	 <p>TWISTER</p>	 <p>WILLY.40</p>	 <p>WILLY</p>

**D8-9013
D8-9014**

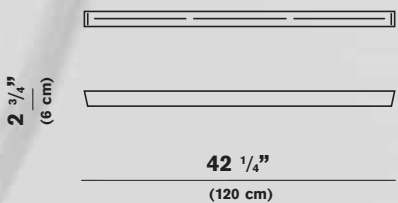

TO BE ORDERED WITH D8-9015 OR D8-9016 DETAILS
A ORDONNER AVEC DES ACCESSOIRES D8-9015 OU D8-9016
DE ORDENAR CON ACCESORIOS D8-9015 O D8-9016

INDEX

INDEX - INDEX

TOURBILLON	pag. 4
D8-1067	5
D8-3095	6
D8-3096	7
D8-1068	7

DOMINO	pag. 8
D8-2041	8
D8-2043	9
D8-3068	10
D8-3071	10
D8-2045	11
D8-2033	12
D8-2037	12
D8-2036	13
D8-4079	14
D8-4081	14
D8-4080	15
D8-4083	16
D8-1047	17
D8-1048	17
D8-1045	18
D8-1046	18
D8-2034	18
D8-2035	18
D8-2038	18
D8-1049	18
D8-1050	18
D8-3069	19
D8-3070	19
D8-3072	19
D8-3073	19
D8-2039	20
D8-2040	20
D8-2042	20
D8-2044	20
D8-2046	21
D8-2047	21
D8-2082	21
D8-2084	21

SHADOW	pag. 22
D8-3093	23
D8-3094	23

ALL STARS	pag. 24
D8-3080	26
D8-3081	28
D8-3082	29

BOLLARD	pag. 32
D8-4091	33
D8-4090	34
D8-3087	35
D8-3088	35

TWISTER	pag. 38
D8-3001	39
D8-3063	40
D8-3064	40
D8-4000	41
D8-4001	41
D8-4074	42
D8-4002	43
D8-1000	44
D8-1001	44
D8-3000	45
D8-4072	45
D8-4073	45
D8-1042	45
D8-1043	45
D8-3001	45

KUBIK	pag. 46
D8-1002	47
D8-1003	47
D8-3004	48
D8-3005	49
D8-3003	50
D8-4003	50
D8-4004	50
D8-3002	51
D8-4005	52

BLOW	pag. 54
D8-1005	55
D8-4007	56
D8-4008	57
D8-3006	58
D8-2000	58
D8-4006	59
D8-1004	59

BLOW MINI	pag. 60
D8-3008	61
D8-1006	62
D8-4010	63
D8-4009	64

ALVI	pag. 66
D8-1007	67
D8-3010	68
D8-2001	69
D8-2002	69
D8-4012	70
D8-4011	71
D8-4013	72
D8-4014	72
D8-3009	73

DELPHINA	pag. 74
D8-2003	75
D8-1008	76
D8-2005	78
D8-2004	79

DENIS	pag. 80
D8-4015	81
D8-4016	81
D8-3011	82
D8-3012	83
D8-3014	83
D8-3013	83
D8-1009	84
D8-1010	84
D8-4017	84

DISCO	pag. 86
D8-2006	87
D8-2007	87
D8-2008	87

TECLA	pag. 88
D8-4066	89
D8-3053	90
D8-3055	92
D8-3057	92
D8-2028	93
D8-2030	94
D8-2026	94
D8-4071	96
D8-3054	97
D8-3056	97
D8-3058	97
D8-2027	97
D8-2029	97
D8-2031	97
D8-4067	97
D8-4068	97
D8-4069	97
D8-4070	97

LIBRA	pag. 98
D8-4018	99
D8-4020	100
D8-4019	103
D8-2009	101
D8-2010	101
D8-3016	102
D8-3015	102
D8-3018	102
D8-3017	102

LUCILLA	pag. 104
D8-4023	105
D8-4024	106
D8-4021	106
D8-4022	107
D8-3019	108
D8-3000	108
D8-3001	108

NOA	pag. 110
D8-4025	111

SPYRA	pag. 112
D8-3022	113
D8-4026	114
D8-4027	114
D8-1011	115
D8-1012	115
D8-4028	116
D8-4029	116

ZENITH	pag. 118
D8-4030	119
D8-4031	119
D8-3067	120
D8-3024	121
D8-4033	122
D8-4077	123
D8-1044	124
D8-2011	124
D8-3023	125
D8-4075	125
D8-4076	125
D8-3025	125
D8-3066	125
D8-4078	125
D8-4032	125
D8-1013	125
D8-2032	125
D8-2011	125
D8-3065	125
D8-3023	125

WILLY	pag. 126
D8-1014	127
D8-4034	129
D8-3027	130
D8-2012	131
D8-4035	132
D8-1056	133
D8-1059	134
D8-1060	134
D8-1057	135
D8-1058	137

MINE	pag. 138
D8-1066	139
D8-1063	140
D8-1065	140
D8-1064	140
D8-2054	141
D8-3092	142
D8-2052	142
D8-2053	142
D8-1071	143
D8-1017	143
D8-1072	143
D8-1018	143
D8-1073	143
D8-1019	143

WAVE	pag. 144
D8-3097	145
D8-2055	148
D8-2056	149
D8-1069	150
D8-1070	151
D8-1071	151
D8-1017	151
D8-1072	151
D8-1018	151
D8-1073	151
D8-1019	151

BIRNE	pag. 152
D8-3074	153

CANDLE	pag. 154
D8-2049	155
D8-2050	155
D8-2051	155

JAZZ	pag. 158
D8-1016	159
D8-1019	159
D8-1015	160
D8-1017	160
D8-1018	161
D8-3028	162
D8-4036	164
D8-4037	164

BLUES	pag. 166
D8-1025	168
D8-1022	170
D8-1023	170
D8-1024	171
D8-1020	172
D8-1021	172
D8-4038	173
D8-4039	175
D8-3029	176

TU-B	pag. 178
D8-3032	180
D8-3030	181
D8-3031	181
D8-4040	182
D8-2013	183
D8-1027	184
D8-2014	185
D8-2015	185
D8-2016	185
D8-1026	185
D8-4021	186

WING	pag. 188
D8-1028	191
D8-3034	193
D8-3036	193
D8-3033	196
D8-3035	196
D8-2017	196
D8-1029	197
D8-2018	197

WING MINI	pag. 192
D8-3059	192
D8-3061	193
D8-3060	193
D8-3062	193

GLIM	pag. 198
D8-2020	199
D8-3037	201
D8-1030	204
D8-2019	205
D8-3038	205
D8-1031	205

GLIM MINI	pag. 205
D8-2025	198
D8-3052	200
D8-1040	204
D8-3051	205
D8-2024	205
D8-1041	205

LOOP	pag. 206
D8-1032	210
D8-3039	207

PLANET	pag. 212
D8-3040	214
D8-3042	214
D8-1035	213
D8-1033	215

BLISSY	pag. 216
D8-4057	217
D8-4053	218
D8-4048	219
D8-4052	219
D8-3045	220
D8-1036	222
D8-3043	223
D8-4050	223
D8-4054	223
D8-1038	223
D8-4056	223
D8-4058	223
D8-4049	223
D8-4051	223
D8-4055	223
D8-1037	223
D8-1039	223
D8-4059	223

CLASSIC	pag. 224
D8-4063	225
D8-4060	226
D8-4061	226
D8-3050	227
D8-3047	228
D8-4065	230
D8-3049	231
D8-4062	231
D8-3048	231
D8-4064	231

CARRÉ	pag. 232
D8-3090	232
D8-4092	233
D8-3091	234
D9-9017	235

PICTURE LIGHT	pag. 236
D8-5007	236
D8-5010	236
D8-5002	236
D8-5009	237
D8-5004	237
D8-5001	238
D8-5012	238
D8-5006	239
D8-5011	239
D8-5003	239
D8-5005	239
D8-5008	239
D8-5000	239

OFFSET	pag. 240
D8-9003	240
D8-9004	240
D8-9007	240
D8-9008	240
D8-9009	240
D8-9010	240
D8-9011	240
D8-9012	240

ACCESSORY	pag. 243
------------------	-----------------

INDEX

NUMERICAL ORDER

INDEX - INDEX

D8-1000	44	D8-1066	139	D8-2056	149	D8-3064	40	D8-4039	175
D8-1001	44	D8-1067	5	D8-2082	21	D8-3065	125	D8-4040	182
D8-1002	47	D8-1068	7	D8-2084	21	D8-3066	125	D8-4048	219
D8-1003	47	D8-1069	150	D8-3000	108	D8-3067	120	D8-4049	223
D8-1004	59	D8-1070	151	D8-3000	45	D8-3068	10	D8-4050	223
D8-1005	55	D8-1071	143	D8-3001	108	D8-3069	19	D8-4051	223
D8-1006	62	D8-1071	151	D8-3001	39	D8-3070	19	D8-4052	219
D8-1007	67	D8-1072	143	D8-3001	45	D8-3071	10	D8-4053	218
D8-1008	76	D8-1072	151	D8-3002	51	D8-3072	19	D8-4054	223
D8-1009	84	D8-1073	143	D8-3003	50	D8-3073	19	D8-4055	223
D8-1010	84	D8-1073	151	D8-3004	48	D8-3074	153	D8-4056	223
D8-1011	115	D8-2000	58	D8-3005	49	D8-3080	26	D8-4057	217
D8-1012	115	D8-2001	69	D8-3006	58	D8-3081	28	D8-4058	223
D8-1013	125	D8-2002	69	D8-3008	61	D8-3082	29	D8-4059	223
D8-1014	127	D8-2003	75	D8-3009	73	D8-3087	35	D8-4060	226
D8-1015	160	D8-2004	79	D8-3010	68	D8-3088	35	D8-4061	226
D8-1016	159	D8-2005	78	D8-3011	82	D8-3090	232	D8-4062	231
D8-1017	143	D8-2006	87	D8-3012	83	D8-3091	234	D8-4063	225
D8-1017	151	D8-2007	87	D8-3013	83	D8-3092	142	D8-4064	231
D8-1017	160	D8-2008	87	D8-3014	83	D8-3093	23	D8-4065	230
D8-1018	143	D8-2009	101	D8-3015	102	D8-3094	23	D8-4066	89
D8-1018	151	D8-2010	101	D8-3016	102	D8-3095	6	D8-4067	97
D8-1018	161	D8-2011	124	D8-3017	102	D8-3096	7	D8-4068	97
D8-1019	143	D8-2011	125	D8-3018	102	D8-3097	145	D8-4069	97
D8-1019	151	D8-2012	131	D8-3019	108	D8-4000	41	D8-4070	97
D8-1019	159	D8-2013	183	D8-3022	113	D8-4001	41	D8-4071	96
D8-1020	172	D8-2014	185	D8-3023	125	D8-4002	43	D8-4072	45
D8-1021	172	D8-2015	185	D8-3023	125	D8-4003	50	D8-4073	45
D8-1022	170	D8-2016	185	D8-3024	121	D8-4004	50	D8-4074	42
D8-1023	170	D8-2017	196	D8-3025	125	D8-4005	52	D8-4075	125
D8-1024	171	D8-2018	197	D8-3027	130	D8-4006	59	D8-4076	125
D8-1025	168	D8-2019	205	D8-3028	162	D8-4007	56	D8-4077	123
D8-1026	185	D8-2020	199	D8-3029	176	D8-4008	57	D8-4078	125
D8-1027	184	D8-2024	205	D8-3030	181	D8-4009	64	D8-4079	14
D8-1028	191	D8-2025	198	D8-3031	181	D8-4010	63	D8-4080	15
D8-1029	197	D8-2026	94	D8-3032	180	D8-4011	71	D8-4081	14
D8-1030	204	D8-2027	97	D8-3033	196	D8-4012	70	D8-4083	16
D8-1031	205	D8-2028	93	D8-3034	193	D8-4013	72	D8-4090	34
D8-1032	210	D8-2029	97	D8-3035	196	D8-4014	72	D8-4091	33
D8-1033	215	D8-2030	94	D8-3036	193	D8-4015	81	D8-4092	233
D8-1035	213	D8-2031	97	D8-3037	201	D8-4016	81	D8-5000	239
D8-1036	222	D8-2032	125	D8-3038	205	D8-4017	84	D8-5001	238
D8-1037	223	D8-2033	12	D8-3039	207	D8-4018	99	D8-5002	236
D8-1038	223	D8-2034	18	D8-3040	214	D8-4019	103	D8-5003	239
D8-1039	223	D8-2035	18	D8-3042	214	D8-4020	100	D8-5004	237
D8-1040	204	D8-2036	13	D8-3043	223	D8-4021	106	D8-5005	239
D8-1041	205	D8-2037	12	D8-3045	220	D8-4021	186	D8-5006	239
D8-1042	45	D8-2038	18	D8-3047	228	D8-4022	107	D8-5007	236
D8-1043	45	D8-2039	20	D8-3048	231	D8-4023	105	D8-5008	239
D8-1044	124	D8-2040	20	D8-3049	231	D8-4024	106	D8-5009	237
D8-1045	18	D8-2041	8	D8-3050	227	D8-4025	111	D8-5010	236
D8-1046	18	D8-2042	20	D8-3051	205	D8-4026	114	D8-5011	239
D8-1047	17	D8-2043	9	D8-3052	200	D8-4027	114	D8-5012	238
D8-1048	17	D8-2044	20	D8-3053	90	D8-4028	116	D8-9003	240
D8-1049	18	D8-2045	11	D8-3054	97	D8-4029	116	D8-9004	240
D8-1050	18	D8-2046	21	D8-3055	92	D8-4030	119	D8-9007	240
D8-1056	133	D8-2047	21	D8-3056	97	D8-4031	119	D8-9008	240
D8-1057	135	D8-2049	155	D8-3057	92	D8-4032	125	D8-9009	240
D8-1058	137	D8-2050	155	D8-3058	97	D8-4033	122	D8-9010	240
D8-1059	134	D8-2051	155	D8-3059	192	D8-4034	129	D8-9011	240
D8-1060	134	D8-2052	142	D8-3060	193	D8-4035	132	D8-9012	240
D8-1063	140	D8-2053	142	D8-3061	193	D8-4036	164	D9-9017	235
D8-1064	140	D8-2054	141	D8-3062	193	D8-4037	164		
D8-1065	140	D8-2055	148	D8-3063	40	D8-4038	173		

INDEX

ALPHABETICAL ORDER

INDEX - INDEX

ACCESSORY pag. 243	CLASSIC pag. 224	JAZZ pag. 158	PICTURE LIGHT pag. 236	TWISTER pag. 38
ALL STARS pag. 24	D8-4063 225	D8-1016 159	D8-5007 236	D8-3001 39
D8-3080 26	D8-4060 226	D8-1019 159	D8-5010 236	D8-3063 40
D8-3081 28	D8-4061 226	D8-1015 160	D8-5002 236	D8-3064 40
D8-3082 29	D8-3050 227	D8-1017 160	D8-5009 237	D8-4000 41
ALVI pag. 66	D8-3047 228	D8-1018 161	D8-5004 237	D8-4001 41
D8-1007 67	D8-4065 230	D8-3028 162	D8-5001 238	D8-4074 42
D8-3010 68	D8-3049 231	D8-4036 164	D8-5012 238	D8-4002 43
D8-2001 69	D8-4062 231	D8-4037 164	D8-5000 239	D8-1000 44
D8-2002 69	D8-3048 231	KUBIK pag. 46	D8-5006 239	D8-1001 44
D8-4012 70	D8-4064 231	D8-1002 47	D8-5011 239	D8-3000 45
D8-4011 71	DELPHINA pag. 74	D8-1003 47	D8-5003 239	D8-4072 45
D8-4013 72	D8-2003 75	D8-3004 48	D8-5005 239	D8-4073 45
D8-4014 72	D8-1008 76	D8-3005 49	D8-5008 239	D8-1042 45
D8-3009 73	D8-2005 78	D8-3003 50	PLANET pag. 212	D8-1043 45
BIRNE pag. 152	D8-2004 79	D8-4003 50	D8-3040 214	D8-3001 45
D8-3074 153	DENIS pag. 80	D8-4004 50	D8-3042 214	WAVE pag. 144
BLISSY pag. 216	D8-4015 81	D8-3002 51	D8-1035 213	D8-3097 145
D8-4057 217	D8-4016 81	D8-4005 52	D8-1033 215	D8-2055 148
D8-4053 218	D8-3011 82	LIBRA pag. 98	SHADOW pag. 22	D8-2056 149
D8-4048 219	D8-3012 83	D8-4018 99	D8-3093 23	D8-1069 150
D8-4052 219	D8-3014 83	D8-4020 100	D8-3094 23	D8-1070 151
D8-3045 220	D8-3013 83	D8-4019 103	SPYRA pag. 112	D8-1071 151
D8-1036 222	D8-1009 84	D8-2009 101	D8-3022 113	D8-1072 151
D8-3043 223	D8-1010 84	D8-2010 101	D8-4026 114	D8-1018 151
D8-4050 223	D8-4017 84	D8-3016 102	D8-4027 114	D8-1073 151
D8-4054 223	DISCO pag. 86	D8-3015 102	D8-1011 115	D8-1019 151
D8-1038 223	D8-2006 87	D8-3018 102	D8-1012 115	WILLY pag. 126
D8-4056 223	D8-2007 87	D8-3017 102	D8-4028 116	D8-1014 127
D8-4058 223	D8-2008 87	LOOP pag. 206	D8-4029 116	D8-4034 129
D8-4049 223	DOMINO pag. 8	D8-1032 210	TECLA pag. 88	D8-3027 130
D8-4051 223	D8-2041 8	D8-3039 207	D8-4066 89	D8-2012 131
D8-4055 223	D8-2043 9	LUCILLA pag. 104	D8-4066 89	D8-4035 132
D8-1037 223	D8-3068 10	D8-4023 105	D8-3053 90	D8-1056 133
D8-1039 223	D8-3071 10	D8-4024 106	D8-3055 92	D8-1059 134
D8-4059 223	D8-2045 11	D8-4021 106	D8-3057 92	D8-1060 134
BLOW pag. 54	D8-2033 12	D8-4022 107	D8-2028 93	D8-1057 135
D8-1005 55	D8-2037 12	D8-3019 108	D8-2030 94	D8-1058 137
D8-4007 56	D8-2036 13	D8-3000 108	D8-2026 94	WING pag. 188
D8-4008 57	D8-4079 14	D8-3001 108	D8-4071 96	D8-1028 191
D8-3006 58	D8-4081 14	MINE pag. 138	D8-3054 97	D8-3034 193
D8-2000 58	D8-4080 15	D8-1066 139	D8-3056 97	D8-3036 193
D8-4006 59	D8-4083 16	D8-1063 140	D8-3058 97	D8-3033 196
D8-1004 59	D8-1047 17	D8-1065 140	D8-2027 97	D8-3035 196
BLOW MINI pag. 60	D8-1048 17	D8-1064 140	D8-2029 97	D8-2017 196
D8-3008 61	D8-1045 18	D8-2054 141	D8-2031 97	D8-1029 197
D8-1006 62	D8-1046 18	D8-3092 142	D8-4067 97	D8-2018 197
D8-4010 63	D8-2034 18	D8-2052 142	D8-4068 97	WING MINI pag. 192
D8-4009 64	D8-2035 18	D8-2053 142	D8-4069 97	D8-3059 192
BLUES pag. 166	D8-1049 18	D8-1071 143	D8-4070 97	D8-3061 193
D8-1025 168	D8-1050 18	D8-1017 143	TOURBILLON pag. 4	D8-3060 193
D8-1022 170	D8-3069 19	D8-1072 143	D8-1067 5	D8-3062 193
D8-1023 170	D8-3070 19	D8-1018 143	D8-3095 6	ZENITH pag. 118
D8-1024 171	D8-3072 19	D8-1073 143	D8-3096 7	D8-4030 119
D8-1020 172	D8-3073 19	D8-1019 143	D8-1068 7	D8-4031 119
D8-1021 172	D8-2039 20	NOA pag. 110	TU-B pag. 178	D8-3067 120
D8-4038 173	D8-2040 20	D8-4025 111	D8-3032 180	D8-3024 121
D8-4039 175	D8-2042 20	OFFSET pag. 240	D8-3030 181	D8-4033 122
D8-3029 176	D8-2044 20	D8-9003 240	D8-3031 181	D8-4077 123
BOLLARD pag. 32	D8-2046 21	D8-9004 240	D8-4040 182	D8-1044 124
D8-4091 33	D8-2047 21	D8-9007 240	D8-2013 183	D8-2011 124
D8-4090 34	D8-2082 21	D8-9008 240	D8-1027 184	D8-3023 125
D8-3087 35	D8-2084 21	D8-9009 240	D8-2014 185	D8-4075 125
D8-3088 35	GLIM pag. 198	D8-9000 240	D8-2015 185	D8-4076 125
CANDLE pag. 154	D8-2020 199	D8-9008 240	D8-2016 185	D8-3025 125
D8-2049 155	D8-3037 201	D8-9009 240	D8-1026 185	D8-3066 125
D8-2050 155	D8-1030 204	D8-9010 240	D8-4021 186	D8-4078 125
D8-2051 155	D8-2019 205	D8-9011 240	WING pag. 188	D8-4032 125
CARRÉ pag. 232	D8-3038 205	D8-9012 240	D8-1028 191	D8-1013 125
D8-3090 232	D8-1031 205	LIBRA pag. 98	D8-3034 193	D8-2032 125
D8-4092 233	GLIM MINI pag. 205	D8-4018 99	D8-3036 193	D8-2011 125
D8-3091 234	D8-2025 198	D8-4020 100	D8-3033 196	D8-3065 125
D9-9017 235	D8-3052 200	D8-4019 103	D8-3035 196	D8-3023 125
	D8-1040 204	D8-2009 101	D8-2017 196	
	D8-3051 205	D8-2010 101	D8-1029 197	
	D8-2024 205	D8-3016 102	D8-2018 197	
	D8-1041 205	D8-3015 102		
		D8-3018 102		
		D8-3017 102		
		LOOP pag. 206		
		D8-1032 210		
		D8-3039 207		
		LUCILLA pag. 104		
		D8-4023 105		
		D8-4024 106		
		D8-4021 106		
		D8-4022 107		
		D8-3019 108		
		D8-3000 108		
		D8-3001 108		
		MINE pag. 138		
		D8-1066 139		
		D8-1063 140		
		D8-1065 140		
		D8-1064 140		
		D8-2054 141		
		D8-3092 142		
		D8-2052 142		
		D8-2053 142		
		D8-1071 143		
		D8-1017 143		
		D8-1072 143		
		D8-1018 143		
		D8-1073 143		
		D8-1019 143		
		NOA pag. 110		
		D8-4025 111		
		OFFSET pag. 240		
		D8-9003 240		
		D8-9004 240		
		D8-9007 240		
		D8-9008 240		
		D8-9009 240		
		D8-9010 240		
		D8-9011 240		
		D8-9012 240		